

This seal is your assurance that Nintendo has reviewed this product and that it has met our standards for excellence in workmanship, reliability and entertainment value. Always look for this seal when buying games and accessories to ensure complete compatibility with your Nintendo Product.



Thank you for selecting the Wii™ console.

IMPORTANT: To protect your health and safety, and to ensure correct use of the Wii console, please carefully read the following instructions in this operations manual before using the Wii console. This operations manual contains important health and safety information. Please keep this book for future reference.

NOTE: This product only plays PAL Wii Discs. This product is not compatible with Nintendo GameCube™ Game Discs or accessories, and does not play CD/DVD discs.

Contents

1 Health and Safety Information	4
2 For Safe Use	6
3 Components	10
4 System Setup	15
5 Using the Wii Remote™ Plus	23
6 Synchronising your Wii Remote Plus with the Wii Console	27
7 Using the Nunchuk™	29
8 Using Discs	31
9 Using SD Cards	32
10 Troubleshooting	33
11 Privacy Warning for the Wii Network Services	36
12 Disposal of this Product at the End of its Life	37

Health and Safety Information

IMPORTANT SAFETY INFORMATION – READ THE FOLLOWING WARNINGS BEFORE SET UP OR USE OF THE Wii CONSOLE. IF THIS PRODUCT IS TO BE USED BY YOUNG CHILDREN, THIS MANUAL SHOULD BE READ AND EXPLAINED TO THEM BY AN ADULT. FAILING TO DO SO MAY CAUSE INJURY.

⚠ WARNING – SEIZURES

Some people (about 1 in 4000) may have seizures or blackouts triggered by light flashes or patterns, and this may occur while they are watching TV or playing video games, even if they have never had a seizure before.

Anyone who has had a seizure, loss of awareness, or other symptom linked to an epileptic condition, should consult a doctor before playing a video game.

Parents should supervise children when playing video games. Stop play immediately and consult a doctor if your child or you have any of the following symptoms: **convulsion, eye or muscle twitching, loss of awareness, altered vision, involuntary movements, disorientation.**

To reduce the probability of a seizure when playing video games:

- Sit or stand as far from the screen as possible.
- Play video games on the smallest available television screen.
- Do not play if you are tired or need sleep.
- Play in a well-lit room.
- Take a 10 to 15 minute break every hour.

⚠ WARNING – REPETITIVE MOTION INJURIES AND EYESTRAIN

Playing video games can make your muscles, joints, skin or eyes hurt. Follow these instructions to help avoid problems such as tendonitis, carpal tunnel syndrome, skin irritation or eyestrain:

- Avoid excessive play. Parents should monitor their children to ensure appropriate playing time.
- Take a 10 to 15 minute break every hour, even if you don't think you need it.
- If your hands, wrists, arms or eyes become tired or sore while playing, or if you feel symptoms such as tingling, numbness, burning or stiffness, stop and rest for several hours before playing again.
- If you continue to have any of the above symptoms or other discomfort during or after play, stop playing and see a doctor.

⚠ WARNING – ELECTRIC SHOCK

To avoid the possibility of experiencing an electric shock when you use this console:

- Do not use the Wii console during a lightning storm. There may be a risk of electric shock from lightning.
- Only use the Wii Power Supply that comes with your console.
- Do not use the Wii Power Supply if it is damaged, split or if there are any broken cords or wires showing.
- Make sure that the Wii Power Supply plug is fully inserted into the wall socket or extension cable socket.
- Always carefully disconnect all plugs by pulling on the plug and not on the cord. Make sure the POWER Button is switched off before removing the Power Supply plug from a socket.

⚠ CAUTION – MOTION SICKNESS

Playing video games can cause motion sickness in some players. Stop playing immediately if you experience dizziness, nausea, fatigue, motion sickness or similar symptoms, or if you experience discomfort in your eyes, hands or arms or otherwise feel unwell at any time during game play. Do not drive or engage in other physical activity until you feel better.

⚠ WARNING – RADIO FREQUENCY INTERFERENCE

The Wii console and Wii Remote Plus can emit radio waves that can affect the operation of nearby electronics, including cardiac pacemakers.

- Do not operate the Wii console or Wii Remote Plus within 25 cm (10 inches) of a pacemaker.
- If you have a pacemaker or other implanted medical device, do not use the Wii console or Wii Remote Plus without first consulting your doctor or the manufacturer of your medical device.

⚠ WARNING – EXPOSURE TO RADIO FREQUENCY RADIATION

To comply with RF exposure compliance requirements, a separation distance of at least 20 cm must be maintained between the Wii console and all persons. This console must not be co-located or operating in conjunction with any other antenna or transmitter.

⚠ CAUTION – LASER DEVICE

The Wii console is a Class I laser product. Do not attempt to disassemble the Wii console. Servicing of the product should be carried out by the Nintendo Service Centres only. **CAUTION:** Making any adjustments to or performing any procedures on the Wii console that are not detailed in this operations manual may result in hazardous radiation exposure.

Specifications:

Laser Type:	Semiconductor laser
Laser wave length:	662 nm (typ.) (647 nm ~ 687 nm)
Laser power:	Max. 0.9 mW
Numeric aperture:	0.6

⚠ CAUTION – BRIGHTNESS OF TV SCREEN

The brightness of the TV screen differs with each TV but can typically be adjusted. Always play games with the appropriate brightness setting. Excessive brightness or darkness can cause discomfort. If necessary, please refer to the instruction manual of your TV for guidance on how to adjust the brightness of your TV.

⚠ WARNING – DANGEROUS PARTS FOR CHILDREN

Not suitable for children under 36 months of age – strangulation hazard. The Wii Remote wrist strap and the cord of the Nunchuk can coil around the neck. The protective film of the Sensor Bar consists of small parts and could be swallowed.

⚠ WARNING – PREGNANCY AND MEDICAL CONDITIONS

Consult your doctor before playing Wii games that may require physical activity if you are pregnant, suffer from heart, respiratory, back, joint or orthopaedic problems, have high blood pressure, or if your doctor has instructed you to restrict your physical activity or if you have any other medical condition that may be aggravated by physical activity. Persons receiving treatment for an injury or disorder involving the fingers, hands or arms should NOT use the rumble function of the Wii Remote Plus.

NOTE: This product does not contain latex.

This product complies with applicable laws prohibiting the use of toxic materials such as lead, mercury, cadmium, hexavalent chromium, PBB or PBDE in consumer products.

The Wii console has been designed with your safety in mind. However, incorrect use could result in accidents including fire and electrocution. Please read the following Health and Safety Information to help reduce the risk of accidents.

■ IMPORTANT NOTE FOR PARENTS

Before allowing any child to use the Wii console, a parent or other responsible adult should determine whether the Wii console is appropriate for the child. Only children who are old enough and capable of wearing the wrist strap and properly gripping the Wii Remote Plus should use the console. You should also consider whether children should be supervised while playing games, connecting to the internet, and/or downloading games. Be sure to explain all safety and health information and instructions to any children who are going to use the console. Failure to do so may result in injuries or damage to the console or other property.

■ Regular Inspections

Before each use, regularly check to see that there is no damage to the Power Supply's cord, that there is no dust collected between the socket and the plug and that there is no dust blocking the console's intake and outtake vents.

■ When Something Seems Wrong

If you notice any damage to the console or the Power Supply's cord or if it makes a strange noise, smells strange, or gives off smoke:

1. Turn off the power immediately. Please take care when touching the console in this event.
2. Remove the Power Supply's AC plug from the socket.
3. Immediately contact a Nintendo Service Centre (contact details at the end of this manual) so that the console may be inspected. Do not attempt to repair the console yourself. Doing so will invalidate your warranty.

■ When Normal Operations Cease

If the console stops working normally, please see the chapter "Troubleshooting" on pages 33–35 in this manual and at the end of the separate "Wii Operations Manual – Channels & Settings".

■ Maintaining Vents

Dust easily gathers around the vents; clean them regularly to remove the dust. Should dust collect and the console overheat, there is a possibility that a fire or other accident could occur.

Please make sure that you have read all the relevant Warnings in this manual before playing.

⚠ WARNING

Failure to follow the advice and Warnings in this manual could lead to serious harm and accidents resulting in death or injury.

⚠ WARNING

Failure to follow the Health and Safety Information and Warnings may cause physical harm, including death or injury, from fire and/or electrocution.

IMPORTANT: Please carefully review the instruction booklet of the game you are playing as well as the separate Health and Safety Precautions booklet included with each game for additional health and safety information.

⚠ WARNING

The Wii console is not intended for children under 36 months of age.

⚠ WARNING

The Wii console contains a built-in lithium button battery (CR2032) which powers the calendar and clock functions.

⚠ USAGE NOTES

- The lithium button battery is not rechargeable so it must not be connected to a battery charger.
- Do not disassemble the lithium button battery. In case of inappropriate handling of the lithium button battery there could be a risk of combustion or explosion.
- Do not take the lithium button battery apart or modify it.
- Do not damage, crush, pierce or expose the lithium button battery to temperatures above 60 degrees Celsius, in particular the lithium button battery must not be thrown into a fire.
- Do not allow a metal object to touch the terminals of the lithium button battery.
- Do not leave the power on after the lithium button battery has lost its charge. When the lithium button battery (CR2032) which powers the calendar and clock functions becomes drained, take it out of the console. Please see the following page for advice on how to remove the lithium button battery.
- When replacing the Wii console's battery, do not use any battery other than a lithium button battery (CR2032). There could be a risk of combustion or explosion if any other type of battery is used.
- The lithium button battery should be removed from the Wii console before disposing of the unit. When disposing of the lithium button battery, please refer to the "Battery Disposal" information on page 8.
- Please dispose of the Wii console separately in accordance with your local recycling laws and regulations. (Please refer to the chapter "Disposal of this Product at the End of its Life" on page 37 for more information.)

Please see the following page for instructions on how to remove the lithium button battery. The following precautions need to be taken when handling lithium button batteries. Improper handling may result in battery leakage, overheating, explosion, or malfunction of the console.

⚠ WARNING

If a battery or battery fluid is accidentally ingested, consult a doctor immediately. If leaked battery fluid comes into contact with your eyes, immediately flush your eyes thoroughly with water and see a doctor, as it may result in blindness or other injury. If leaked battery fluid comes into contact with your body or hands, wash thoroughly with soap and water. If leaked battery fluid comes into contact with the console, carefully wipe the console, avoiding direct contact with your hands. Contact the battery manufacturer for further information.

Replacing the built-in lithium button battery (CR2032)

1. Do not remove the battery cover unless instructed to do so by a Nintendo Service Centre representative.
2. Batteries should be replaced by a parent or guardian.
3. The lithium button battery should be stored out of the reach of children.
4. Always turn the power off and disconnect the Power Supply before replacing the lithium button battery.
5. Use a precision screwdriver and loosen the screw on the battery cover. Remove the battery cover and take out the lithium button battery. Do not apply excessive force. Always use an appropriate screwdriver for the screw.
6. Using the wrong screwdriver may damage the head of the screw and you will not be able to remove the battery cover.
7. Use only a lithium button battery (CR2032) for battery replacement of the Wii console. Always insert a new lithium button battery (CR2032). Make sure to orient the lithium button battery correctly (with the negative (-) terminal facing down). Do not use damaged, deformed or leaking batteries as they may seriously damage the Wii console.
8. Replace the battery cover in its original position and carefully tighten the screw.
9. When disposing of the lithium button battery, please refer to the "Battery Disposal" information below.

Battery Disposal

- Discarding the lithium button battery in your general household waste can be harmful to the environment. When disposing of the lithium button battery, follow appropriate local guidelines and regulations.
- In accordance with the Directive on Batteries and Accumulators and Waste Batteries and Accumulators (2006/66/EC), battery collection and recycling schemes should be in place in all EU Member States by 26th September 2008. Such schemes may already be available in your country, in which case the lithium button battery should not be disposed of in your general household waste. For further information contact your local solid waste authority.

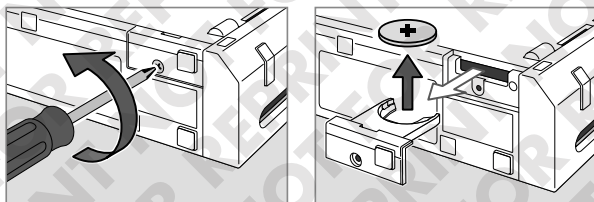

Wii Power Supply Handling Precautions

Please note the following precautions when handling the Wii Power Supply. Failure to do so could result in fire, electrocution, or other damage.

⚠ WARNING

- Only use the Wii Power Supply (RVL-002(UKV)) included with the Wii console (RVL-101(EUR)).
- The exclusive Power Supply conforms to Low Voltage Directive (2006/95/EC).
- The Power Supply is intended only as the power supply for the Wii console.
- The Power Supply is for indoor use only.
- If you hear a strange noise, see smoke, or smell something strange when using the Wii console, immediately turn off the power, disconnect the AC plug from the wall socket, and contact the nearest Nintendo Service Centre.
- The Power Supply used with the Wii console should be regularly examined for damage to the cord, plug enclosure and other parts.
- Do not disassemble, modify, or attempt to repair the Power Supply.
- If the external flexible cable or cord of the Power Supply becomes damaged, it should be replaced by the Nintendo Service Centre in order to avoid any potential hazards.
- Do not plug or unplug the Power Supply with wet or sweaty hands.
- Do not use a Power Supply that has come into contact with any liquids or has had a foreign object inserted into it. In the event that this has happened, contact the nearest Nintendo Service Centre.
- Do not store or use the Power Supply in humid, dusty, or smoky environments.
- Do not use the Power Supply in places where it may be splashed with water or any other liquids, such as juice, pet urine or oil. Also avoid using the Power Supply in extremely humid places.
- Do not touch the AC pins on the plug with your fingers, or metal objects.
- Do not step on, pull, or excessively bend the Power Supply or cables.
- Do not overload the circuit by connecting an excessive amount of equipment (in daisy-chains).
- Please clean dust from the AC plug periodically using a dry cloth.
- Turn the console off first and pull on the plug rather than the cable. Pulling on the cable could damage it and may result in a fire or electrocution.
- Do not heat or place Power Supplies or cables near stoves or heaters.
- Do not apply excessive force to the cables (especially at the base of the cable).
- When the console is not being used for an extended period of time, always disconnect the Power Supply from the wall socket, and place it in a location where small children cannot reach it.
- Always ensure that the AC pins on the plug are fully inserted into the socket.
- As a safety precaution, when you hear thunder, it is recommended to disconnect the Wii console and to not touch the Power Supply or the console.
- Do not use travel transformers or incandescent-specific light dimmers because it may change the power voltage.
- The Power Supply should be plugged into an easily accessible socket that is near the equipment to be charged.

3 Components

Wii Console (RVL-101(EUR))

POWER LED

Shows the status of the Wii console.

- Green
Console power is ON.
- Orange
Standby Mode,
WiiConnect24 is ON.
- Red
Standby Mode,
WiiConnect24 is OFF.

POWER Button

Press to turn the console on or off (**Standby Mode**).

NOTE: The POWER LED does not go out when the power is turned off.

Disc Slot

For inserting a Wii Disc. The disc slot blinks blue when you turn the console power on or when a disc is inserted while the console power was turned off. When WiiConnect24 is set to ON, the slot will blink when messages or data are received.

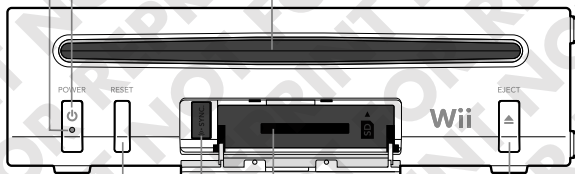

RESET

Press to restart a game.

SD Card Slot

For inserting an SD Card.

EJECT Button

Press to eject a Wii Disc.

SYNC.

Press the SYNC. Buttons on the Wii Remote or Wii Remote Plus and the Wii console simultaneously to synchronise the Wii Remote or Wii Remote Plus. See pages 27–28.

Sensor Bar Connector

Connects to the Sensor Bar.

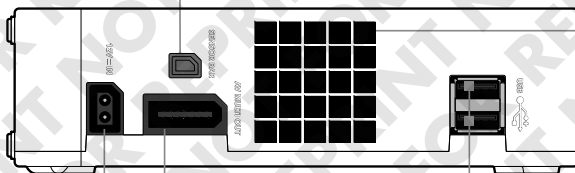

DC Input Connector

Connects to the Wii Power Supply.

AV Multi Out Connector

Connects to the AV cable for your television.

USB Connectors

• Connect USB devices such as the Wii LAN Adapter (RVL-015) (sold separately).

Do not connect any device that is not supported by Nintendo.

Air Intake

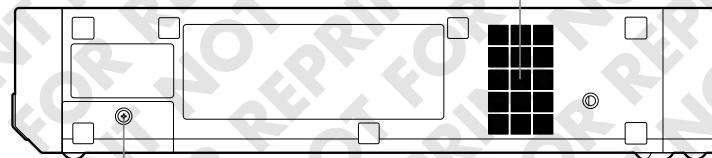

Battery Cover

For access to lithium button battery (CR2032). The battery cover can be removed to replace the lithium button battery if necessary. See page 8 for more information on replacing the lithium button battery. Do not remove the battery cover unless instructed to do so by a Nintendo Service Centre representative.

Air Vent

Do not block.

Wii Remote Plus (RVL-036)

(Shown with the Wii Remote Jacket installed.)

POWER Button

Press to turn the Wii Remote Plus and Wii console on or off.

NOTE: The POWER Button can be operated with the Wii Remote Jacket in place.

+ Control Pad

A Button

- Button

Speaker

1 Button

2 Button

Pointer

Wii Remote Jacket (RVL-022)

HOME Button

Press to display the HOME Menu.

Please refer to page 60 of the separate "Wii Operations Manual – Channels & Settings" for more information.

+ Button

Player LED

Lights to indicate which player the Wii Remote Plus is set up for.

(Shown with the battery cover removed.)

B Button

Strap Lock

Wrist Strap Attachment Hole

External Extension Connector

Allows connection of external accessories such as the Nunchuk.

Wrist Strap Cord

NOTE: Battery life can be checked by pressing the HOME Button. See page 60 of the separate "Wii Operations Manual – Channels & Settings".

Wii Remote Wrist Strap (RVL-018)

See pages 24–25 for information on Wii Remote wrist strap use.

SYNC.

Press the SYNC. Buttons on the Wii Remote Plus and the Wii console simultaneously to synchronise the Wii Remote Plus. See pages 27–28.

Depending on the version of the included Wii Remote Plus, there may be a protrusion used for pressing the SYNC. Button while the battery cover is closed and the Wii Remote Jacket is covering the Wii Remote Plus.

Nunchuk (RVL-004)

Control Stick

C Button

Z Button

NOTE: If the Control Stick is moved out of neutral position at certain times (see below), that position will be set as neutral position, causing incorrect game control during game play. Do not push the buttons or move the Control Stick out of neutral position when:

- Turning on the Wii console.
- Plugging the Nunchuk into the Wii Remote Plus.
- Starting a game or Channel.
- Returning to the **Wii Menu** from games or Channels.

To reset neutral position, do the following:

Take your fingers off the Control Stick and simultaneously hold down the A Button, B Button, + Button and - Button on the connected Wii Remote Plus for approximately three seconds.

Sensor Bar (RVL-014)

Sensor Bar Plug

Plugs into the Sensor Bar connector on the back of the Wii console. See page 19 for installation instructions.

Connector Hook

Insert the Wii Remote wrist strap cord through the connector hook.

Nunchuk Plug

Connects to the external extension connector on the Wii Remote Plus.

Lock/Release Levers

Squeeze levers to remove plug from the Wii Remote Plus.

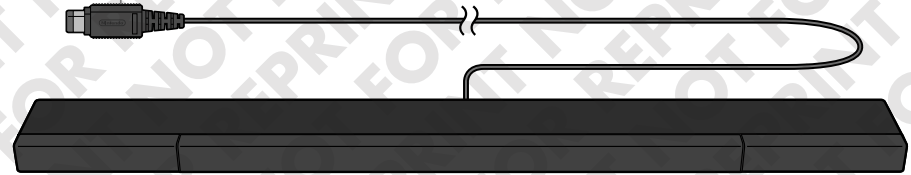
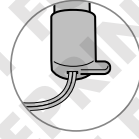
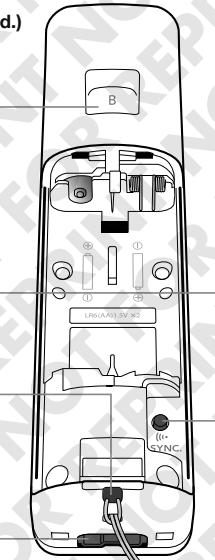
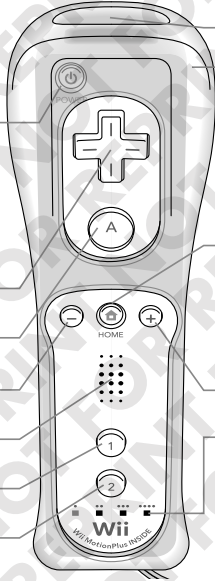
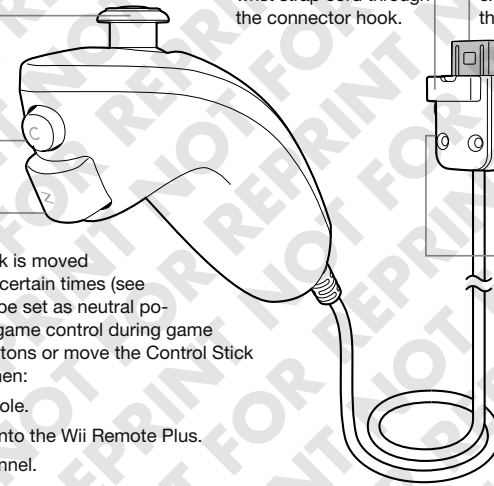

Wii Power Supply (RVL-002 (UKV))

AC Plug

Connects to a 230V AC wall socket.

DC Plug

Connects to the DC input connector on the back of the Wii console.



Wii AV Cable (RVL-009)

AV Multi Out Plug

Plugs into the AV Multi Out connector on the back of the Wii console.

RCA Plugs

Plug into the AV input connectors on the TV (or to the Euro Connector Plug in case your TV has a Euro Type 21 pin jack).

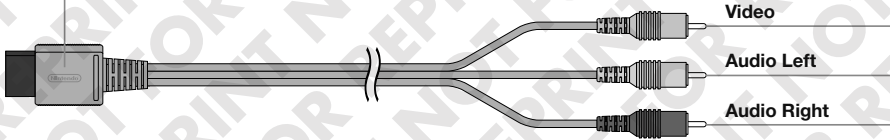

Euro Connector Plug (SNSP-015)

Connects to AV input connectors on TV or VCR.

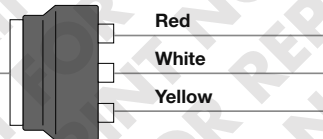

4

System Setup

Wii Console Usage Precautions

Please read and follow the guidelines listed below when setting up and using the Wii console (RVL-101 (EUR)). Failure to do so may result in damage to your Wii console or accessories.

- The Wii console is for indoor use only.
- The Power Supply used with the console should be examined regularly for damage to the cord, plug enclosure and other parts.
- If the Power Supply used with the console is damaged, it must not be used until the damage has been repaired.
- The console is to be disconnected from the Power Supply before cleaning.
- The console has intake and exhaust vents designed to maintain adequate ventilation. Do not operate the console in any location where these vents may become covered or obstructed, for example, on carpet or in a tightly enclosed space. Keep vents clear of any dust or other foreign material.
- Do not open, disassemble, modify or try to repair the Wii console, components or accessories. Doing so will invalidate your warranty. Please always contact your nearest Nintendo Service Centre for repairs.
- After you have finished playing, be sure to remove the disc from the console.
- Do not store the Wii console in a humid place, on the floor, or in any location where it may collect dirt, dust, lint, etc.
- Do not drop, hit or otherwise damage the Wii console, components or accessories.
- When disconnecting any plugs from the console or wall socket, first turn the Wii console off. Then carefully pull by the plug itself rather than by the cord.
- Do not step on, sharply pull or bend any wires or cables.
- Do not expose the Wii console, components or accessories to extreme heat or cold.
- Do not spill any liquids on the Wii console, components or accessories. To clean, use a soft, slightly damp cloth. Use water only. Allow to dry completely before using.

Console Placement

The Wii console should be placed on a flat horizontal surface. Choose a location to set up the Wii console that has enough room to allow for free flow of ventilation around the console.

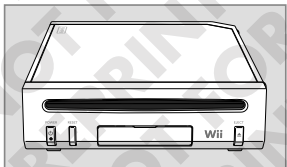

Connecting the AV cable

NOTE: Before proceeding with cable connections, turn off the power for the TV and any audio equipment that the console will be connected to.

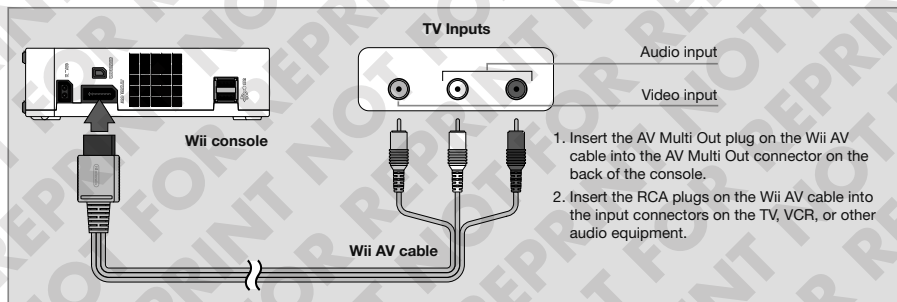

NOTE: This illustration shows the TV or VCR Connection in case your TV has a Euro Type 21 pin jack.

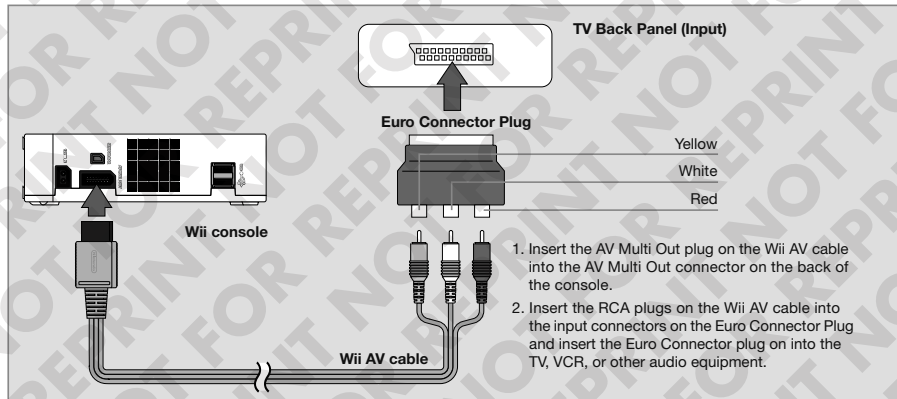

NOTE: For higher quality video, a Wii Component Video cable or the Wii RGB cable can be used (Please contact the Nintendo Service Centre for details of how and where to purchase). Before purchase, check to make sure your TV has component video inputs.

■ Separately-Sold Option cables

You can enjoy games with better video quality by using a separately-sold option cable.

- Televisions with a component video input terminal Wii Component Video cable (RVL-011)
- Televisions with a RGB input terminal Wii RGB cable (RVL-013)

■ Precautions On the Use of AV Cables

The following cables cannot be used.

- Nintendo GameCube Stereo Audio/Video cable (SNSP-008)
- Nintendo GameCube RGB cable (DOL-013(EUR))

TV and Audio / Video Settings

After you have completed all steps of the setup procedure and are ready to use the Wii console, you will need to set the appropriate "Input Select" setting for your TV, VCR or other audio equipment.

1. Turn ON the power for your TV and any audio equipment connected to your gameplay setup and the power on the Wii console.
2. Select the correct input setting for your TV (see "Input Select Information" below).
3. The **Wii Menu** should appear on the TV screen. See the separate Wii Operations Manual – Channels & Settings included with your Wii console for more information on using this feature.

If the **Wii Menu** does not appear, check to make sure your input setting is correct and review the chapter "Troubleshooting" on pages 33–35.

■ Input Select Information

Manufacturers of TVs and VCRs use different names and locations for "Input Select". The most common names for the input select are: input, select, input select, line, line in, source, in, EXT, and AUX. Consult your TV or VCR instruction manual for details.

NOTE: The input select allows you to switch between the different inputs on your TV or VCR. Usually this would be between the Antenna input and the Audio/Video input(s).

Locate the input select for the component that the Wii AV cable is connected to (either the TV or VCR). The most common locations for input select are:

- A button on the front of the TV or VCR.
- A button on the remote control.
- A high-numbered or low-numbered channel (92, 99, 00, or 02) on the TV or VCR.
- An on-screen menu selection.

⚠ CAUTION – TV SCREEN DAMAGE

Some televisions can be damaged by the display of a stationary image, because the image may be permanently "burned" into the screen (screen burn-in). Playing video games with stationary images or patterns, or leaving video games on hold or pause, may lead to this type of damage. The Wii console comes with a Screen Burn-In Reduction feature which is designed to reduce the risk of this happening when activated (for more details please see page 46 of the separate "Wii Operations Manual – Channels & Settings").

PLEASE NOTE: This Screen Burn-In Reduction feature will not work when playing some Wii software. To reduce the risk of screen burn-in when you break from playing, we recommend pausing the game and turning the TV off until you are ready to play again. Your TV may also have its own screen burn-in reduction function, which may fade back the screen imagery or darken it entirely. Please follow your TV manufacturer's recommendations to avoid screen burn-in.

Before using your Wii console with any TV, especially front and rear projection or plasma models, be sure to review all documentation included with your TV to find out whether video games can be played on the TV without damaging it.

If in doubt, contact the manufacturer of the TV. Neither Nintendo nor any of Nintendo's licensees will be liable for any damage to your TV.

Sensor Bar Setup

■ Connecting the Sensor Bar

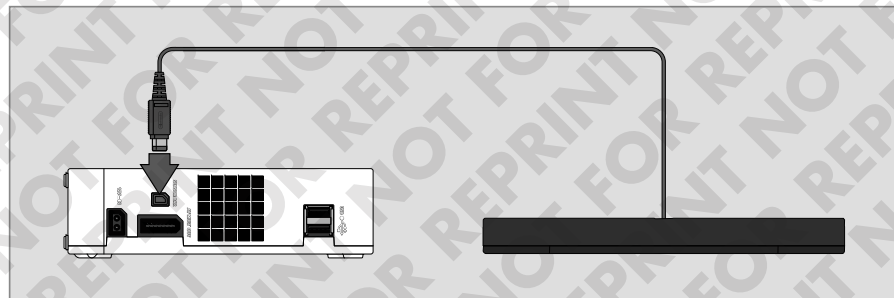

Insert the Sensor Bar plug into the Sensor Bar connector on the back of the console.

■ Placing the Sensor Bar

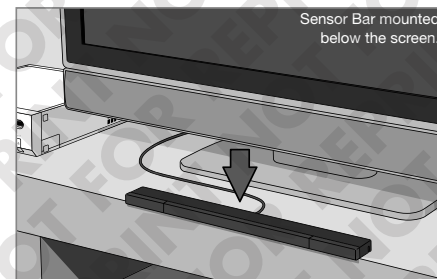
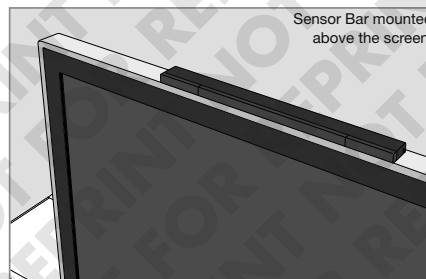

The Sensor Bar can be placed either above or below the TV screen. See page 20 for instructions on mounting the Sensor Bar to the TV screen.

⚠ WARNING – DANGEROUS PARTS FOR CHILDREN

Not suitable for children under 36 months of age – choking hazard. The protective film of the Sensor Bar consists of small parts and could be swallowed.

■ Mounting the Sensor Bar above the Screen



1. Remove the protective film from the foam tapes on the bottom of the Sensor Bar.



2. Mount the Sensor Bar to the top of the TV.

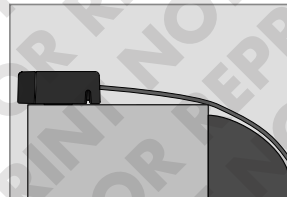

The front of the Sensor Bar should be aligned with the front of the TV.

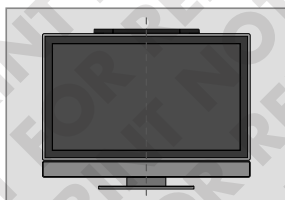

The centre of the Sensor Bar should be aligned with the centre of the TV.

■ Mounting the Sensor Bar below the Screen



1. Remove the protective film from the foam tapes on the bottom of the Sensor Bar.

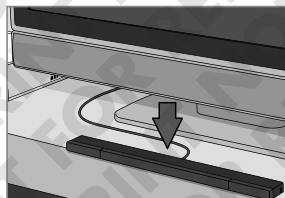

2. Mount the Sensor Bar to the front edge of the surface the TV is sitting on. Do not place the Sensor Bar below the surface that the TV is sitting on. For example, on shelves below the TV.

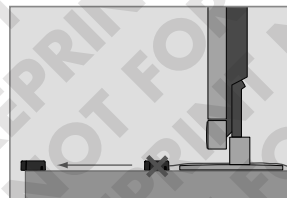

The front of the Sensor Bar should be aligned with the front of the surface the TV is sitting on.

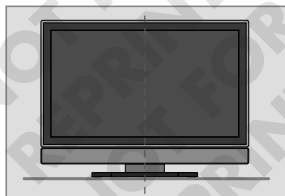

The centre of the Sensor Bar should be aligned with the centre of the TV.

■ Sensor Bar Cable Position

If desired, the Sensor Bar cable can be fed through a channel on the bottom of the Sensor Bar to orient the cable to the left or right.

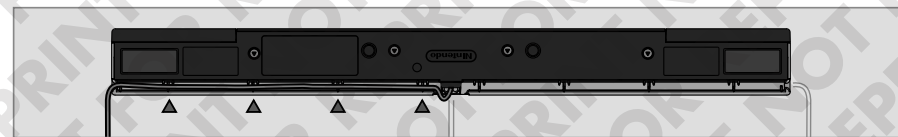

For best results when using the Wii console, follow these recommendations

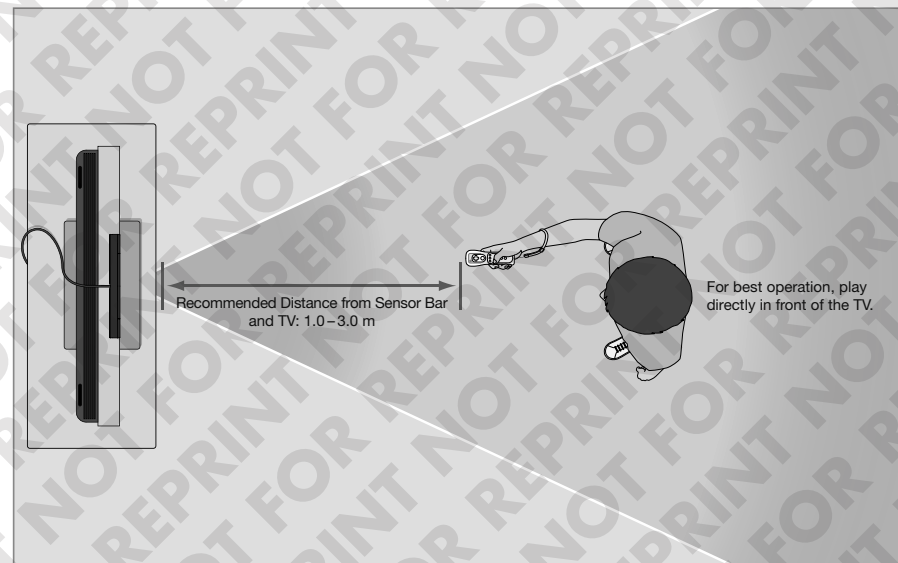

⚠ CAUTION - ADEQUATE SPACE REQUIRED

Be sure you have enough space around you during gameplay. To reduce the possibility of injury or damage, make sure other people or objects are not within your range of motion when playing.

For best function of the Sensor Bar follow these guidelines:

- Avoid blocking the signal between the Wii Remote Plus, the Sensor Bar and the Wii console with objects.
- Use the Wii Remote Plus with the correct distance from the Sensor Bar and TV. The optimal distance is between 1.0-3.0 m.
- Avoid bright light sources, including sunlight, behind or near the TV, shining towards the Wii Remote Plus or reflecting off of the TV screen.
- Avoid highly reflective surfaces near the Sensor Bar.
- Avoid sources of infrared light in the gameplay area such as electric, propane or kerosene heaters, flames from fireplaces or candles, and stoves or other sources of heat.

Be sure to read the following pages on using the Wii Remote Plus and Nunchuk before using the Wii console.

Power Supply

1. Insert the DC plug on the Power Supply cord into the DC input connector on the back of the console.
2. Insert the AC plug into a 230V AC wall socket.

CAUTION: To reduce the risk of electric shock, fully insert the AC plug into the AC socket.

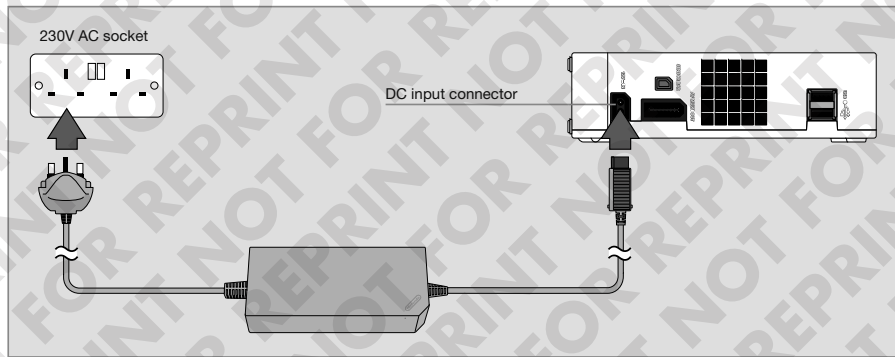

CAUTION: Transformers and power supplies are not to be used as toys. The use of these products by children should only be allowed with the full supervision of a parent or legal guardian.

Cleaning the Wii console

Please read and follow the guidelines below when cleaning the Wii console.

- Do not wipe the Wii console with alcohol or solvents such as benzine or thinner, as the surface of the console may be damaged or deformed.
- If the Wii console or accessories get dirty, wipe them with a soft cloth such as a microfibre cloth for cleaning glasses.
- Before cleaning the Wii console, ensure that there is no disc inserted in the disc slot and that the power is turned off.
- If the Wii Remote Jacket gets dirty, wipe it with a damp cloth, using a neutral detergent diluted in water. Make sure it is completely dry before using it again.

5

Using the Wii Remote™ Plus

Setup of the Wii Remote Plus

The Wii Remote Plus comes with the Wii Remote Jacket attached.

Nintendo recommends leaving the jacket attached to the Wii Remote Plus to avoid harm to the Wii Remote Plus or surrounding objects, or injury to other people, if you lose your grip on the Wii Remote Plus.

The Wii Remote Plus uses AA batteries. Nintendo recommends high-quality alkaline batteries for best performance and longevity of battery life.

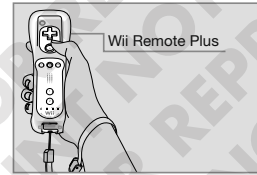

⚠ WARNING – BATTERY PRECAUTIONS

FAILURE TO FOLLOW THE FOLLOWING INSTRUCTIONS COULD RESULT IN THE BATTERIES MAKING “POPPING” SOUNDS AND LEAKING BATTERY ACID RESULTING IN PERSONAL INJURY AND/OR DAMAGE TO YOUR WII REMOTE PLUS. IF A BATTERY OR BATTERY FLUID IS ACCIDENTALLY INGESTED, CONSULT A DOCTOR IMMEDIATELY. IF LEAKED BATTERY FLUID COMES INTO CONTACT WITH YOUR EYES, IMMEDIATELY FLUSH YOUR EYES THOROUGHLY WITH WATER AND SEE A DOCTOR, AS IT MAY RESULT IN BLINDNESS OR OTHER INJURY. IF LEAKED BATTERY FLUID COMES INTO CONTACT WITH YOUR BODY OR HANDS, WASH THOROUGHLY WITH SOAP AND WATER. IF LEAKED BATTERY FLUID COMES INTO CONTACT WITH YOUR WII REMOTE PLUS, CAREFULLY WIPE THE WII REMOTE PLUS, AVOIDING DIRECT CONTACT WITH YOUR HANDS. CONTACT THE BATTERY MANUFACTURER FOR FURTHER INFORMATION.

1. For the Wii Remote Plus, Nintendo recommends high-quality alkaline batteries. It is also possible to use Nickel Metal Hydride (NiMH) rechargeable batteries. Please follow the battery manufacturer's guidelines for safety and proper usage, as failure to do so could damage the Wii Remote Plus and voids your warranty.
2. Do not mix used and new batteries (replace all batteries at the same time).
3. Do not put the batteries in backwards (positive (+) and negative (-) terminals must face the proper direction). Insert the negative end first. The supply terminals are not to be short-circuited.
4. Do not leave flat batteries in the Wii Remote Plus.
5. Do not mix battery types and do not mix different brands of batteries. Use only batteries of the same or equivalent type as recommended.
6. Do not leave batteries in the Wii Remote Plus for long periods of non-use.
7. When the batteries become drained, take them out of the Wii Remote Plus.
8. Do not expose batteries to heat or dispose of batteries in a fire.
9. Do not use a battery if the plastic cover has been torn or damaged in any way.
10. **GENERAL NOTE:** If you decide to use Nickel Metal Hydride rechargeable batteries please note that rechargeable batteries are to be removed from the Wii Remote Plus before charging. Rechargeable batteries are only to be recharged under adult supervision.
11. Non-rechargeable batteries are not to be recharged.
12. The batteries are to be removed from the Wii Remote Plus before disposing of the unit. For disposal of the AA batteries, please refer to the “Battery Disposal” information below.

■ Battery Disposal

- Discarding the batteries in your general household waste can be harmful to the environment. When disposing of the batteries, follow appropriate local guidelines and regulations.
- In accordance with the Directive on Batteries and Accumulators and Waste Batteries and Accumulators (2006/66/EC), battery collection and recycling schemes should be in place in all EU Member States by 26th September 2008. Such schemes may already be available in your country, in which case the batteries should not be disposed of in your general household waste. For further information contact your local solid waste authority.

⚠ WARNING

Not suitable for children under 36 months of age – strangulation hazard. The Wii Remote wrist strap can coil around the neck.

■ Installing Batteries

1. Pull the Wii Remote Jacket off the base of the Wii Remote Plus and pull the Wii Remote wrist strap out of the hole in the bottom of the jacket.

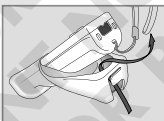

2. Pull the jacket up the Wii Remote Plus far enough to expose the entire battery cover and remove the battery cover.



3. Insert the batteries into the battery chamber. Be sure to insert the minus (-) end first when inserting new batteries, and remove the plus (+) end first when replacing the batteries.

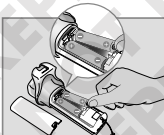

4. Replace the battery cover, thread the Wii Remote wrist strap through the hole in the bottom of the jacket and pull the jacket back over the bottom of the Wii Remote Plus.

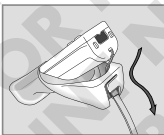

5. If you remove the jacket from the Wii Remote Plus, replace it by inserting the top of the Wii Remote Plus into the large hole on the front of the jacket. Be sure to push it all the way into the inside of the jacket.

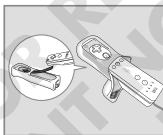

6. Thread the Wii Remote wrist strap through the hole in the bottom of the jacket, as shown in step 4.

7. Insert the connector cover into the external extension connector on the bottom of the Wii Remote Plus.



- Follow the game instructions for releasing or letting go of on-screen objects like balls, swords and the like. Usually you do this by releasing or pushing a button on the Wii Remote Plus. You should NEVER let go of the Wii Remote Plus itself to perform a function in the game.
- If your hands become sweaty or wet for any other reason, stop playing and dry your hands before continuing.
- The Wii Remote Plus responds to minor movements, so excessive or forceful actions are not necessary. We therefore recommend that you do not use excessive, rapid, violent or swinging motions as these might cause you to accidentally let go of the Wii Remote Plus and may break the wrist strap. This could result in injury to people nearby or cause damage to other objects or the Wii Remote Plus, should you lose your grip.

ALLOW ADEQUATE ROOM AROUND YOU DURING GAME PLAY

- You will probably move around while using the Wii Remote Plus, so be careful that the areas that you might move into are kept clear. Make sure that furniture, objects and other people are out of the play area so that you do not accidentally bump into them while playing. Also, be careful of any objects above you (e.g. lamps) that you could collide with if you jump or raise your hands above your head. Of course, such movements are not necessary as the Wii Remote Plus reacts to minor motion. Remember to take extra care if you have low ceilings.
- Stand at least 1 metre away from the television when using the Wii Remote Plus.

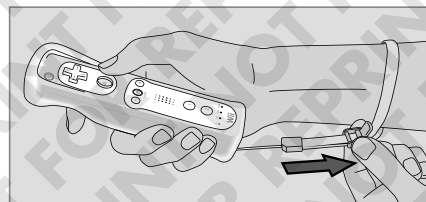

1. Open the lever on the strap lock and place your hand through the Wii Remote wrist strap. Hold the Wii Remote Plus firmly in your hand.
2. Slide the strap lock up so that the strap will not fall off your wrist. Do not over-tighten the strap lock so that it's uncomfortable. It should just be tight enough to hold the Wii Remote wrist strap in place. Close the lever to hold the strap lock in place.

■ Holding the Wii Remote Plus

Depending on the game, the way you hold and operate the Wii Remote Plus will vary. You may need to hold the Wii Remote Plus in either one hand or two. Read the instruction booklet for the game you are playing for information about what kind of gameplay control is required for that game. But always keep hold of the Wii Remote Plus during game play and always wear the Wii Remote wrist strap regardless of how you hold the Wii Remote Plus.

Wii Remote Plus Configurations

- The Wii Remote Plus can be used by itself, or in different configurations when connected up to other Wii accessories. These configurations can be used right or left handed.
- The configuration will depend on the game you are playing. Review the instruction booklet of the game you are playing for specific controller requirements.

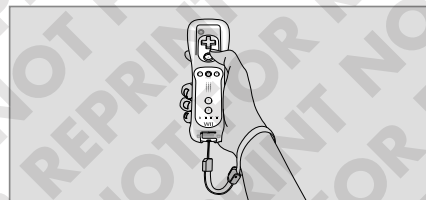

Wii Remote Plus – Vertical Position

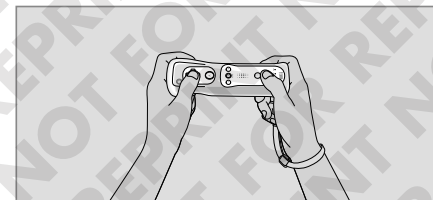

Wii Remote Plus – Horizontal Position

⚠ CAUTION – USE THE Wii REMOTE WRIST STRAP

Always keep a firm grip on the Wii Remote Plus and Nunchuk (if being used). Use the Wii Remote wrist strap at all times to prevent losing your grip on the Wii Remote Plus and possibly causing damage to the Wii Remote Plus and surrounding objects, or injury to other people. Please ensure there is sufficient distance from other people and objects when playing Wii games. Stop playing and dry your hands if they become sweaty or wet. The Wii Remote Plus responds to minor movements so do not use excessive, rapid or wide swinging motions.

ALWAYS WEAR THE WRIST STRAP WHEN USING THE Wii REMOTE PLUS

- Make sure all players use the wrist strap and that the strap lock is correctly tightened.
- When sharing the Wii Remote Plus between multiple players, make sure that each person using the Wii Remote Plus uses the wrist strap properly.
- Wearing the wrist strap will help prevent the Wii Remote Plus from being thrown across the room or dropped if you accidentally let go of it during game play.

HOLD THE Wii REMOTE PLUS (AND THE NUNCHUK IF BEING USED) FIRMLY; DON'T LET GO, AND DON'T USE EXCESSIVE MOTION DURING GAME PLAY

- Even while wearing the wrist strap, make sure you don't let go of the Wii Remote Plus during game play.
- You should NEVER let go of the Nunchuk (if being used) or let it swing loose during game play.

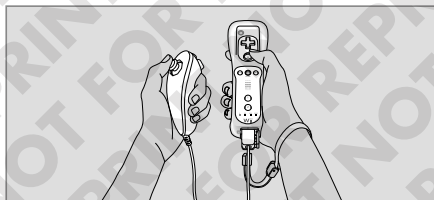

Wii Remote Plus and Nunchuk



Wii Remote Plus and Classic Controller / Classic Controller Pro (sold separately)

Basic Operations

■ Point

Point the Wii Remote Plus at a specific place on the TV screen.

■ Holding or Grabbing

Point the Wii Remote Plus at a specific place on the TV screen and move the Wii Remote Plus, while holding down a button.

■ Waving

Wave the Wii Remote Plus back and forth from side to side.

■ Pushing or Pulling

Move the Wii Remote Plus forwards and backwards, while holding down a button.

■ Twisting

Move the Wii Remote Plus in a twisting motion by rotating your arm.

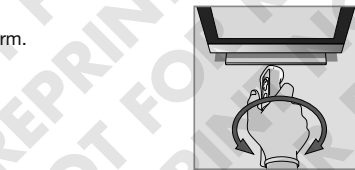
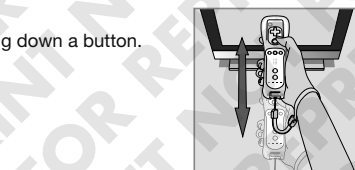
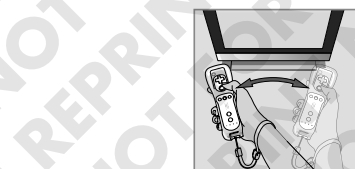
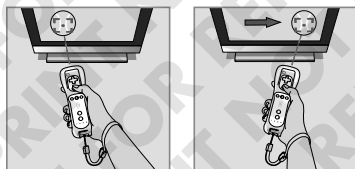
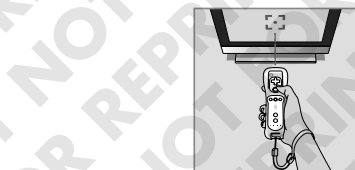

6

Synchronising your Wii Remote Plus with the Wii Console

The Wii Remote Plus included with your Wii console has already been synchronised with the console. The **Standard Mode** procedure is used when adding additional Wii Remote or Wii Remote Plus controllers to your console or if you want to re-synchronise your original Wii Remote Plus. This procedure allows the Wii Remote or Wii Remote Plus to communicate with the console.

There are two different modes of synchronising (synching)

Standard Mode – Once synchronised, the Wii Remote or Wii Remote Plus will stay synched to the console unless you overwrite this setting by synching the Wii Remote or Wii Remote Plus to a different console.

One-Time Mode – This mode allows you to temporarily use your Wii Remote or Wii Remote Plus on a console other than your own or to use a friend's Wii Remote or Wii Remote Plus on your console. **It does not delete the Standard Mode setting stored in the Wii Remote or Wii Remote Plus.** In this mode, the Wii Remote or Wii Remote Plus will only communicate with the console while the power is on. When the power is turned off, the Wii Remote or Wii Remote Plus will lose its synch with the console.

• A Wii console can have up to 16 Wii Remote or Wii Remote Plus controllers synched to it – 10 in **Standard Mode** and 6 in **One-Time Mode**.

• Only a Wii Remote or Wii Remote Plus in **Standard Mode** can turn the console power on or off.

■ Standard Mode Synchronisation

NOTE: Make sure you have placed batteries in the Wii Remote or Wii Remote Plus.

1. Remove the battery cover on the back of the Wii Remote or Wii Remote Plus (1a). Please note that, depending on the model of the Wii Remote Plus, you may be able to press the SYNC. Button without removing the battery cover (1b).
2. Open the SD Card slot cover on the front of the Wii console.
3. Press SYNC. underneath the battery cover of the Wii Remote or Wii Remote Plus briefly, and release it. Then press SYNC. on the in-side of the SD Card slot compartment briefly, and release it.
4. The Player LEDs will blink during the synching process. When the blinking stops, connection is complete. The LED that is illuminated indicates the player number.

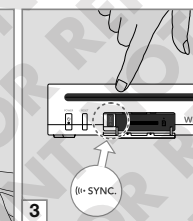
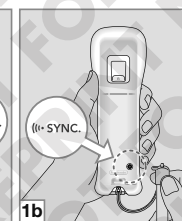
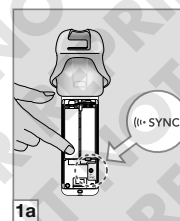

This procedure must be followed for each additional Wii Remote or Wii Remote Plus added to your console. The order in which you synch Wii Remote or Wii Remote Plus controllers sets the player order for multiplayer games. See section "One Time Mode Synchronisation" below for information on temporarily changing the player order for the Wii Remote or Wii Remote Plus controllers.

■ One Time Mode Synchronisation

NOTE: This mode temporarily removes **Standard Mode** synchronisation setup for all Wii Remote or Wii Remote Plus controllers until the power of the Wii console is turned off. When the power is turned back on again, the **Standard Mode** settings will return.

1. Press the HOME Button on a Wii Remote or Wii Remote Plus that is synchronised with the console.

- Select the **Wii REMOTE SETTINGS** option from the **HOME Menu**, then select the **RECONNECT** option.



- Press the 1 and 2 Buttons simultaneously on the Wii Remote or Wii Remote Plus that you want to synchronise with the console. **The order in which you synchronise Wii Remote or Wii Remote Plus controllers will set the player order for multiplayer games.**



- The Player LED will blink during the synching process. Hold the buttons down until the blinking stops, which indicates that the connection is complete.

During the synching process, the number of LEDs that blink will show the battery life of the Wii Remote or Wii Remote Plus that is being synchronised.

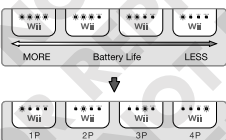

After the synching process, LED that is lit shows the player number for that Wii Remote or Wii Remote Plus.

NOTE: Bear in mind that **One-Time Mode** synchronisation is temporary. The Wii Remote or Wii Remote Plus will lose this synchronisation under the following conditions:

- When you turn off the console by pressing the **POWER** Button on either the Wii Remote/Wii Remote Plus or the Wii console.
- When starting a game or Channel.
- When returning to the **Wii Menu** after exiting from a game or Channel.
- When you select **RESET** from the **HOME Menu**.
- When you press the **RESET** Button on the front of the Wii console.

Important Wireless Communication Guidelines

- Begin with the distance from the TV screen with properly-mounted Sensor Bar at about 1.0 to 3.0 metres.
- The player should face the TV screen (with properly-mounted Sensor Bar) as directly as possible.
- Avoid having people or other obstructions between you and the Wii console.
- Avoid interference from other devices. If communication seems to be affected by other devices (wireless LAN, microwave ovens, cordless devices, computers), move to another location or turn off the interfering device.

NOTE: If your **Wii Remote or Wii Remote Plus** loses its synchronisation with the console and you are unable to re-synch it, try the following procedure:

- Turn off the power of the Wii console with the **POWER** Button on the front of the console.
- Unplug the **Wii Power Supply** from the power socket for 10 seconds, then plug it back in again.
- Turn the power of the Wii console and try re-synchronising the **Wii Remote or Wii Remote Plus**.

7

Using the Nunchuk™

Setup and Use of the Nunchuk (RVL-004)

CAUTION: It is important that you always keep a firm grip on the Nunchuk and the Wii Remote Plus to help prevent losing your grip and reduce the risk of causing damage to the Wii Remote Plus, the Nunchuk and surrounding objects, or injury to other people, should you accidentally let go of the Wii Remote Plus or Nunchuk during game play. Wear the Wii Remote wrist strap at all times, and never let the Nunchuk swing loose. Please ensure there is sufficient distance from other people and objects when using the Wii Remote Plus and Nunchuk to avoid colliding with other persons or things.

Be sure to install the Nunchuk as described. Use the connector hook on the Nunchuk plug with the Wii Remote wrist strap cord to prevent the Nunchuk plug from becoming separated from the external extension connector on the Wii Remote Plus and striking objects or people.

⚠ WARNING

Not suitable for children under 36 months of age – strangulation hazard. The cord of the Nunchuk can coil around the neck.

■ Connecting the Nunchuk

- Feed the cord on the Wii Remote wrist strap through the connector hook.

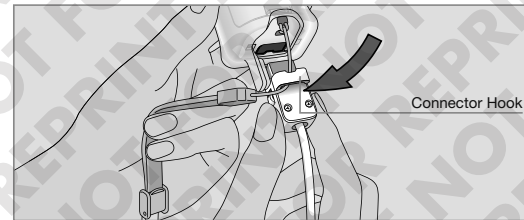

- Insert the Nunchuk plug into the external extension connector on the bottom of the Wii Remote Plus until it "clicks" into place.

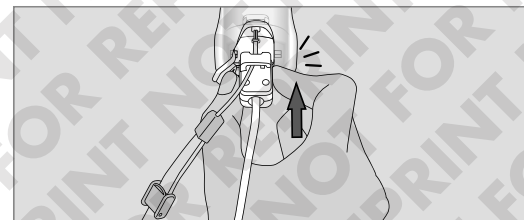

- Open the lever on the strap lock and place your hand through the Wii Remote wrist strap and hold the Wii Remote Plus firmly in your hand. Slide the strap lock up so that the wrist strap will not fall off your wrist. Do not over-tighten the strap lock so that it's uncomfortable. It should just be tight enough to hold the Wii Remote wrist strap in place. Close the lever to hold the strap lock in place. (See page 24, "Use the Wii Remote Wrist Strap".)

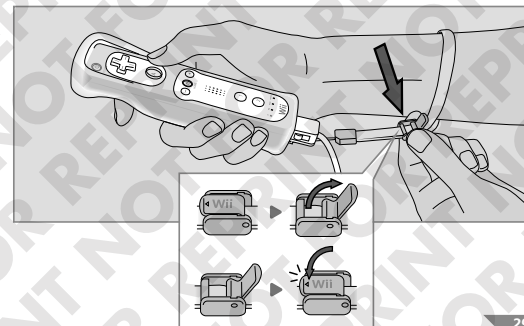

■ Holding the Nunchuk and Wii Remote Plus (Nunchuk Style)

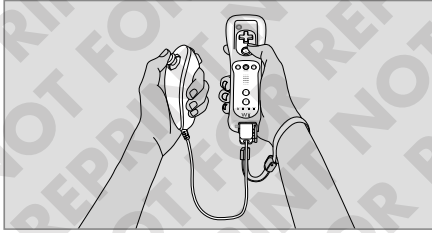

NOTE: Make sure the Wii Remote wrist strap cord runs through the connector hook.

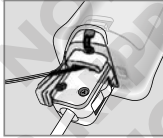

■ Disconnecting the Nunchuk

Press the lock / release levers on the side of the Nunchuk plug and pull the plug straight out of the external extension connector on the bottom of the Wii Remote Plus.

Lock/Release Levers

Squeeze levers to remove plug from the Wii Remote Plus.

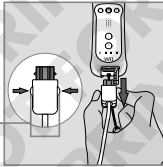

8

Using Discs

Disc Usage Precautions

Please read and follow the guidelines listed below when using Wii Discs in the Wii console. Failure to do so may result in damage to your Wii console or discs.

- Do not touch the unprinted bottom surface of the disc. Always handle the disc by the edges.
- Do not use cracked, damaged or repaired discs.
- Do not bend or put excessive pressure on discs when loading into the console.
- Do not leave discs in direct sunlight or expose them to high temperatures, high humidity or dust, dirt or other contaminants.
- When not using discs, store them in their cases to prevent them from getting scratched, dirty or damaged.
- Do not write on, or place stickers on any part of the disc.
- Do not put foreign matter on the disc.
- If a disc becomes dirty or contaminated with fingerprints, the console may not be able to read the game data correctly. If necessary, clean the disc with a soft, slightly damp cotton cloth (use water only). Clean the disc from the centre towards the edges; do not use a circular motion.



Wii Discs (RVL-006(EUR))

Using a Wii Disc

■ Before Inserting a Disc

- Turn the power of your TV on and any other audio equipment connected to your gameplay setup.
- Select the correct input setting for your TV. (See page 18, "Input Select Information".)

■ Insert a Disc

Insert your disc into the disc slot on the front of the console, with the disc label facing upwards. The Wii console will turn on automatically.

■ Starting the Game

1. Using the Wii Remote Plus, move the cursor over the Disc Channel panel on the **Wii Menu** and press the A Button to make a selection.

NOTE: Please read the Disc Channel section in the separate Wii Operations Manual – Channels & Settings included with your Wii console for complete information on using discs in the Wii console.

2. Select START on the game's **Channel Preview Screen** to begin the game.

Review the instruction booklet of the game you are playing for specific game control information.

SD Cards are used in many digital cameras and mobile phones, and for data storage on PCs.

The Wii console accepts the following types of SD Memory Card: SD Card/SDHC Card

The following require their respective adapters: miniSD Card/miniSDHC Card/microSD Card/microSDHC Card

An SD Card can be used to store the following data from the Wii System Memory:

- Game save information from Wii games
- Certain data from the Wii Channel applications
- Games downloaded through the Wii Shop Channel such as Virtual Console™ compatible and WiiWare™ games
- Add-on content downloaded within a game

NOTE: Games and add-on content copied or moved to an SD Card cannot be used with a different Wii console. Depending on the game, it may not be possible to copy or move some save information to an SD Card.

See chapter “Wii Settings and Data Management” in the “Wii Operations Manual – Channels & Settings” for details on data management with SD Cards.



SD Card

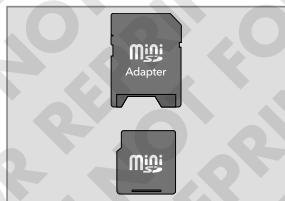

miniSD Card and Adapter

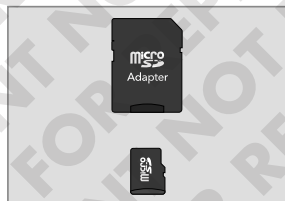

microSD Card and Adapter

To use an SD Card, open the SD Card slot cover on the front of the Wii console and insert the SD Card.

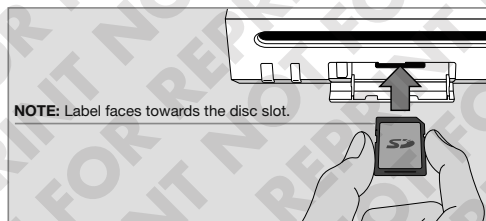

CAUTION: Do not insert or remove SD Cards while reading or writing information to or from the card or initialising the card. Doing so may damage the Wii console or SD Card, or permanently destroy data.

Before seeking assistance, review the following problems and solutions.

■ No picture on TV screen

- Make sure you have completed all steps, in the order that they appear, on the Quick Setup sheet included with your console.
- Make sure that all components of your setup are plugged into power sockets and that all components are turned on.
- Make sure that cable connections are correctly installed and that all plugs are securely plugged into the appropriate connectors.
- Make sure that the input settings are correct for your particular setup. (See page 18, “Input Select Information”)

■ No sound is heard or sound quality is poor

- Make sure the TV volume is not turned off or muted.
- Make sure that all audio connections are correctly installed and that all plugs are securely plugged into the appropriate connectors.
- Make sure the Wii AV cable is plugged into the “input” connectors on the TV or VCR, not the “output” connectors.
- Make sure that the input settings are correct for your particular setup. (See page 18, “Input Select Information”)
- The sound in some games doesn’t begin until the game begins.
- If you have a mono TV or VCR and left one of the audio cables unconnected you may not get all game sounds. Use a “Y” Adapter to get both left and right sound channels.
- If your TV or VCR has both mono and stereo options, make sure it is set to match your setup.
- Check the instruction booklet of the game you are playing to see if there are volume controls or mono/stereo options that can be set from within the game.

■ The console POWER LED does not come on, or goes off during gameplay

- Make sure the Power Supply is plugged into both the wall socket and the back of the console.
- If the light is still off, disconnect the Power Supply’s AC plug from the wall socket, wait 2 minutes and plug it back into the socket. Turn the console power on.

■ Wii Remote Plus does not work or works erratically

- Review the Sensor Bar setup instructions in this manual to ensure proper placement.
- Make sure the batteries are not depleted and the power is turned on.
- If all four blue lights are flashing on the Wii Remote Plus, try to synchronise the Wii Remote Plus. If this does not work, then turn off and unplug the Wii console, leave it for 10 seconds, then plug it back in and switch it back on and re-synchronise the Wii Remote Plus.
- Check the instruction booklet of the game you are playing to make sure you are using the correct controller or accessory.
- Make sure no objects are blocking the signals between the Sensor Bar, the Wii console and the Wii Remote Plus.
- Check and adjust the Sensor Bar sensitivity if necessary. (See page 50 in the separate “Wii Operations Manual – Channels & Settings”.)
- The following conditions can interfere with the operation of the Wii Remote Plus:
 - Using the Wii Remote Plus too close or too far from the Sensor Bar. The optimal distance is between 1.0–3.0 m.
 - Bright light sources, including sunlight, behind or near the TV, shining towards the Wii Remote Plus or reflecting off of the TV screen.
 - Highly reflective surfaces near the Sensor Bar.

- Sources of infrared light in the gameplay area such as electric, propane or kerosene heaters, flames from fireplaces or candles, and stoves or other sources of heat.

If you think any of these conditions are affecting the operation of the Wii Remote Plus, try removing or reducing the source of interference.

■ **Wii Remote Plus stopped working, re-synching does not fix the problem, player LEDs flash and then go off**

- Try a fresh set of batteries.
- Try resetting the Wii Remote Plus – remove the batteries, wait one minute, then replace the batteries. Wait a few seconds and then try using the Wii Remote Plus again.
- The Wii Remote Plus synch information may need to be cleared and the Wii Remote/Wii Remote Plus controllers re-synchronised:
 1. Turn off the console, wait a moment, then turn the console on again.
 2. When you see the **Health and Safety Screen**, press and hold SYNC. on the console down for 15 seconds.
 3. Synchronise your Wii Remote/Wii Remote Plus controllers using the procedure on pages 27–28.
- Radio frequency interference may cause the Wii Remote Plus to work erratically. Check for and move or turn off wireless devices such as cordless phones, wireless computer keyboards or mice, or other similar devices.

■ **Wii Remote Plus works erratically when playing games with Wii MotionPlus features**

The movement of the cursor on screen may not match your movements with the Wii Remote Plus in the following cases:

- If you have changed the batteries during play
- If the room temperature has changed suddenly and significantly

In any of these cases, place the Wii Remote Plus face down on a level surface such as a table and leave it still for several seconds to recalibrate it. The Wii Remote Plus should be at least 50 cm (20 inches) from the television and Wii console in order to be calibrated correctly.

■ **Console unable to read disc or disc will not operate in the console**

NOTE: Discs will not start automatically. You must start the disc from the Disc Channel on the **Wii Menu**.

- Make sure the disc is inserted correctly. The label side of the disc must face up.
- Check to be sure that the disc is clean and in good condition. If dirty, wipe with a soft cloth, from the centre to the outside.
- Eject the disc, and turn the power off and then on. Reinsert the disc and try playing the game again.
- Check that the disc will work on your version of the Wii console. This console will only work with Wii Discs made for use within the EEA and Switzerland.

■ **Wii Remote Plus or controller accessory buttons stick**

Clean sticking buttons using the following procedure:

1. For the Wii Remote Plus, remove batteries and disconnect any accessories before cleaning.
2. Use an unused toothbrush and hot tap water. **Do not use boiling water, soap or detergent.**
3. Dip the toothbrush in hot water and shake off excess. Lightly scrub sticking buttons, working the bristles around sides of buttons and into cracks.
4. Dry controller with soft cloth or towel and let air dry for at least 2 hours.
5. Test buttons and repeat procedure if necessary. **Do not submerge in, or pour any type of liquid onto a controller or accessory.**

■ **Disc slot does not light blue or lights briefly**

This is the normal operation of the disc slot. The slot only lights temporarily **when the console is turned on** by a) inserting a disc, b) using the POWER Button on the Wii Remote Plus or c) using the POWER Button on the Wii console.

The disc slot will also light temporarily if you receive a message via WiiConnect24 (this feature must be turned on to receive messages, see page 58 in the separate “Wii Operations Manual – Channels & Settings” for more information).

■ **Unable to proceed past the Language Select screen**

Make sure you have correctly installed the Sensor Bar. See pages 19–20 for installation procedure.

■ **Response of the Wii Remote Plus is slow**

Depending on your TV, the signal sent to the TV could be displayed only after the image has been processed inside the TV. As this processing time can cause a delay, it is not a failure of the Wii console or Wii Remote Plus.

■ **Does my software support the Nunchuk?**

If the software packaging does not display the icon shown on the right, then the Nunchuk is not supported.



■ **Is my Nunchuk out of neutral position?**

Due to the specific features of the Control Stick, it can occur that you cannot control the Nunchuk correctly when the neutral position is inaccurate. To correctly reset the neutral position, remove your thumb from the Control Stick and press the A, B, + and – Buttons at the same time for 3 seconds on the Wii Remote Plus (see page 13).

If your Wii console still does not operate correctly after trying these troubleshooting steps, we recommend you contact your Nintendo Service Centre in order to obtain more information. Please note that if you return the console to the retailer and the retailer offers to exchange your console, you may lose save data, all Wii Shop Channel downloads and your Wii Points account balance.

Your Wii console allows you to access the Wii Shop Channel service and the WiiConnect24 service (together the “Wii Network Services”). When using the WiiConnect24 service, your Wii console will be connected to the internet giving you the ability to interact with other gamers worldwide in several ways. In order to protect your privacy when using the Wii Network Services, we suggest the following:

■ Parents please read: Protecting Children’s Privacy on the Wii Network Services

- Before allowing your children to use the Wii Network Services, we highly recommend that you educate them on the importance of not sharing any personal information about themselves with strangers. Instruct your children to not use personal information for any nicknames on games, user names in chat rooms, names for Mii characters or any other aspects of the Wii Network Services. Explain to them the danger of receiving messages from, or communicating with, strangers.
- You should supervise your children’s use of the Wii Network Services at all times and assist them with the setup of the Wii Network Services. If at any time you want to stop your children’s use of the Wii Network Services, you should disconnect your Wii console from the internet.

■ Protecting the privacy of your personal information when using the Wii Network Services and Wii Remote / Wii Remote Plus

- Never give out personal information about yourself such as your first or last name, phone number, date of birth, age, e-mail or home address when communicating with strangers or using any aspect of the Wii Network Services.
- When using the Wii Network Services, you may have the option of linking your Wii Shop Channel account to your Club Nintendo account. By linking your accounts, you will be able to register downloaded content and have such registrations reflected in both of your accounts. In addition, Nintendo will be able to connect your activity on the WiiConnect24 service to your Club Nintendo account and send you offers, surveys and promotions for games or other items you are interested in. If you do not want Nintendo to be able to do this, do not link your accounts.
- If you use the messaging features of the Wii console, you need to understand that Nintendo may monitor your use and share your information (i) as required by law, (ii) where necessary to protect the company, its customers or employees, or (iii) as necessary to provide the services.
- If you decide to provide personal information to any third party website, the sharing of such information will be subject to the privacy policy of that company, not Nintendo’s privacy policies. Be cautious before providing any personal information to any third party through the Wii Network Services.
- Your Wii console may store certain personal information on your Wii Remote Plus so please note that by using your Wii Remote Plus on a Wii console other than your own, it is possible that certain personal information about you could be shared with that other Wii console.
- For your protection, before selling, donating or otherwise transferring your Wii console, please be sure to clean and securely remove all of your personal information, including any pictures or messages on the Wii Message Board and all other stored sensitive information from your Wii console. For information on how to remove data from your Wii console refer to the separate Wii Operations Manual – Channels & Settings.

At the end of this product’s life, please do not dispose of this product in your general household waste. Instead, please dispose of this product separately in accordance with your local recycling laws and regulations. For more information on the separate collection systems for waste electrical and electronic equipment that are available for consumers, free of charge, near your home, please contact your local municipal authority.

As an alternative and if you plan to buy an equivalent new product, you may be able to bring this product to your local retailer who, in exchange for your buying an equivalent new product, may take back this product and arrange for its recycling. However, we would suggest that you first double-check with your local retailer whether they will offer you this service.

Either way, this product will then be treated in an environmentally sound manner at a licensed recycling plant and its components will be recovered, recycled or reused in the most efficient way possible, in compliance with the requirements of the Directive on Waste Electrical and Electronic Equipment (2002/96/EC) of 27 January 2003.

Under applicable environmental laws, you should always use the available separate collection systems for waste electrical and electronic equipment. In some countries, failure to use these systems may even result in sanctions being taken against you.

■ Notes:

1. Waste electrical and electronic equipment may contain hazardous substances, which, if not treated properly, can be harmful to the environment and human health. Specific treatment of waste electrical and electronic equipment is therefore indispensable.
2. All Nintendo electrical and electronic equipment that is subject to the above Directive is designed in a way which takes full account of, and facilitates, its possible repair, upgrading, reuse, dismantling and recycling.
3. Nintendo and its official distributors support recycling schemes in each European country and are committed to using the best available treatment, recovery and recycling techniques in order to ensure both human health and high environmental protection.
4. The crossed-out wheeled bin symbol (see below) is affixed to all relevant Nintendo electrical and electronic equipment that has been put onto the market by Nintendo or its official distributors on or after 13 August 2005. The symbol means that these products must be collected separately from other waste at the end of their life, in order to ensure maximum recovery and environmentally sound disposal.



12-MONTH WARRANTY – NINTENDO HARDWARE

CONSUMER WARRANTY

This warranty covers Nintendo consoles, including the original built-in software included with the respective Nintendo consoles at the time of purchase (the "Nintendo Operating Software"). In this warranty, the Nintendo console and the Nintendo Operating Software are referred to together as the "Product". Subject to the terms and exclusions below, Nintendo warrants to the original consumer purchasing the Product ("you") that, for a period of 12 months from the date of the purchase of the Product by you, the Product will be free from defects in materials and workmanship.

To make a valid claim under this warranty, you must notify Nintendo of the defect in the Product within 12 months of the date of the purchase of the Product by you, and you must return the Product to Nintendo within 30 days of notifying Nintendo of that defect. If, having inspected the Product, Nintendo accepts that the Product is defective, Nintendo will (at its sole discretion) either repair or replace the part causing the defect, or replace the Product without charge.

This warranty does not affect any statutory rights which you may have as the purchaser of consumer goods.

EXCLUSIONS

This warranty does not cover:

- software (other than the Nintendo Operating Software) or games (whether included with the Product at the time of purchase or not);
- accessories, peripherals or other items that are intended for use with the Product but are not manufactured by or for Nintendo (whether included with the Product at the time of purchase or not);
- the Product if it was purchased outside the European Economic Area and Switzerland;
- the Product if it has been resold, or used for rental or commercial purposes;
- defects in the Product that are caused by accidental damage, your and/or any third party's negligence, unreasonable use, modification, use with products not supplied, licensed or authorised for use with the Product by Nintendo (including, but not limited to, non-licensed game enhancements, copier devices, adapters, power supplies or non-licensed accessories), computer viruses or connecting to the internet or other forms of electronic communication, use of the Product otherwise than in accordance with the instructions in the respective Nintendo Operations Manual or any other instructions provided with the Product or any other cause unrelated to defects in material and workmanship;
- defects in the Product that are caused by the use of faulty, damaged or leaking batteries or battery packs, or any other use of batteries or battery packs not in accordance with the instructions in the respective Nintendo Operations Manual or Instruction Booklet;
- gradual decrease over time in the capacity and performance of batteries and battery packs for the Product (including NTR-003, USG-003, TWL-003, UTL-003, CTR-003) (which, for the avoidance of doubt, will not be deemed to be a defect in material or workmanship of the Product);
- the Product if it has been opened, modified or repaired by any person or company other than Nintendo or its authorised partners or it has its serial number altered, defaced or removed;
- loss of any data that has been loaded onto or stored on the Product by any person or company other than Nintendo or its authorised partners; or
- loss of data or software as a result of formatting the memory of the Product (or the SD Card being used with the Product).

HOW TO MAKE A CLAIM

To notify Nintendo of a defect covered by this warranty, please contact:

Nintendo Customer Support
PO Box 952, Portsmouth, PO6 9DY
Tel: +44 (0) 845 60 50 247

Calls to this number are charged at national rates for customers in the UK, and at international rates for customers in the Republic of Ireland. Please obtain permission from the person responsible for the bill before calling.

Before sending the Product to Nintendo Customer Support, you should remove or delete any private or confidential files or data. You accept and agree that Nintendo will not be responsible for any loss, deletion or corruption of your files or data that has not been deleted or removed. Nintendo strongly recommends that you make a back up copy of any data that you do not remove or delete. Please note that, depending on the type of repair, data stored in the memory of the Product may be deleted, and you may not be able to read data saved to your SD Card or import it back onto the Product following such repair.

When sending the Product to Nintendo Customer Support, please:

1. use the original packaging where possible;
2. provide a description of the defect;
3. attach a copy of your proof of purchase, ensuring that it indicates the date of purchase of the Product; and
4. ensure that it is received by Nintendo within 30 days of the original notification of a qualifying defect.

If the above 12-month warranty period has expired at the time the defect is discovered or if the defect is not covered by this warranty, Nintendo may still be prepared to repair or replace the part causing the defect or replace the Product (at its sole discretion). For further information or, in particular, details of any charges for such services, please contact:

Nintendo Customer Support
Tel: +44 (0) 845 60 50 247

Calls to this number are charged at national rates for customers in the UK, and at international rates for customers in the Republic of Ireland. Please obtain permission from the person responsible for the bill before calling.

NINTENDO OPERATING SOFTWARE

The Nintendo Operating Software may only be used with Nintendo consoles, and may not be used for any other purpose. You must not copy, adapt, reverse-engineer, decompile, disassemble or modify the Nintendo Operating Software other than as expressly permitted by applicable law. Nintendo may use anti-copying or other measures to protect its rights relating to the Nintendo Operating Software.



Call UK Customer Support for assistance on all Nintendo published/distributed software, hardware and accessories. Our dedicated games counsellors can answer all your gameplay questions, offering hints, tips and strategies to ensure that you get the most from your Nintendo products.

To call UK Customer Support, dial*
+44 (0) 845 60 50 247





(* Calls from a landline within the UK are charged at the standard national rate offered by the caller's network provider. Charges may vary for calls made using a mobile phone.

Customers calling from outside the UK will be charged at the international rate offered by the provider of the network being used to make the international call. Please obtain permission from the person responsible for paying the bill before calling.)

Lines are open Monday to Friday from 08:30 to 19:00, and Saturday from 08:30 to 15:30**.

(** Charges and opening hours are correct at time of printing but are subject to change without prior notice.)

Notes

    D-63760 Großostheim

PLEASE RETAIN THE PACKAGING. VERPACKUNG AUFBEHALTEN. CONSERVARE L'EMBALLAGE. BEWAAR DEZE VERPAKKING.
FOR FAVOR. GUARDAR ESTA CAJA. ΣΤΑΘΕΡΗΣΕΤΗ ΤΗ ΣΥΣΚΕΥΑΣΙΑ. GUARDAR A EMBALLAGEM. SPARA FÖRPACKNINGEN.
GEN EMBALLAGEN. SÄLTÄ PAKKAUS. CONSERVARE QUESTA CONFEZIONE. СОХРАНИТЕ УПАКОВКУ.
TA VARE PÅ EMBALLASJEN.

Nintendo of Europe ("Nintendo") and its products are in compliance with all applicable European Union Directives and Regulations, many of which are aimed at environmental protection as well as consumer health and safety with respect to the manufacture, supply and use of Nintendo products. A brief summary of the applicable EU Directives and Regulations, and Nintendo's compliance with them, can be found on the Nintendo of Europe website: <http://www.nintendo-europe.com/>

BECAUSE OF THE RADIO MODULES INCORPORATED IN THIS PRODUCT, IT IS DESIGNED FOR USE WITHIN THE EEA AND SWITZERLAND AND IS FOR INDOOR USE ONLY. THE POWER SUPPLY INCLUDED IS SUITABLE FOR USE IN THE UK, IRELAND AND MALTA ONLY. DO NOT USE IT IN COUNTRIES WHERE VOLTAGE REQUIREMENTS ARE DIFFERENT.

DECLARATION OF CONFORMITY

Nintendo hereby declares that "Wii" is in compliance with the essential requirements and other relevant provisions of directive 1999/5/EC. This Declaration of Conformity is published on our website. Please visit <http://docs.nintendo-europe.com>

Patent Information

European Patent Numbers: 1,854,518; D431,309-1/6; D483,631-1/12; D614,326-1; D614,771-1; D614,805-1; D614,813-1/2; D614,847-1/2; D614,862-1; D614,870-1/2; D615,000-1; D655,790-1/2; D655,808-1; D851,928-1; D851,936-1/2.

German Utility Model Numbers: 202,006,020,818.6; 202,006,020,819.4.

Other patents pending.

ELEMENTS OF THE Wii CONSOLE AND THE Wii NETWORK SERVICES ARE PATENT PENDING. BOTH IN THE UNITED STATES AND INTERNATIONALLY.
TM, © AND THE Wii LOGO ARE TRADEMARKS OF NINTENDO. ALL RIGHTS RESERVED.
© 2011 NINTENDO.

wii™

OPERATIONS MANUAL *System Setup*



UK and Ireland:
Nintendo UK
PO Box 952, Portsmouth, PO6 9DY
www.nintendo.co.uk

