

NINTENDO DS[®] XL

Operations
Manual

5811146M



UK and Ireland:

Nintendo UK

55-57 High Street, Windsor, Berkshire, SL4 1LP, U.K.

www.nintendo.co.uk



PRINTED IN CHINA

This seal is your assurance that Nintendo has reviewed this product and that it has met our standards for excellence in workmanship, reliability and entertainment value. Always look for this seal when buying games and accessories to ensure complete compatibility with your Nintendo Product.



Thank you for selecting the Nintendo DSi™ XL system.

Thank you for purchasing the Nintendo DSi™ XL system. Please read this Operations Manual before use and follow all the instructions carefully. Additionally, be sure to read the Health and Safety Precautions Booklet. If this product is to be used by young children, this manual should be read and explained to them by an adult. Please keep this manual for future reference.

The Nintendo DSi and Nintendo DSi XL are identical in terms of functionality.

Set Contents

- Nintendo DSi XL system (UTL-001(EUR))



- Nintendo DSi Power Supply (WAP-002(UKV))

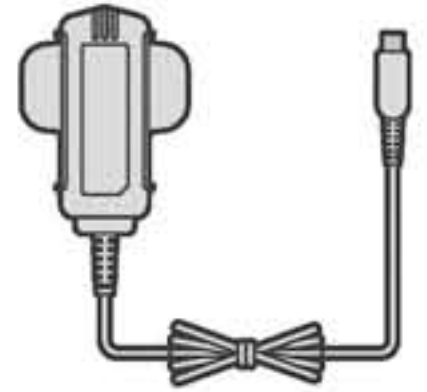

- Nintendo DSi XL stylus (Large) (UTL-005)



- Nintendo DSi XL stylus (UTL-004)

Note: Located in the side of the system.



- Nintendo DSi XL Quick-Start Guide
Read this to get a quick overview of the main features and learn how to load software.
- Nintendo DSi XL Operations Manual
 - Basics
 - Applications and Settings
 - Support and Troubleshooting*

*Read this section if you think your product might be broken.

- Health and Safety Precautions Booklet



Everything on your Nintendo DSi XL system starts from here

The Nintendo DSi XL system comes with a selection of built-in software. Others can be added later from the Nintendo DSi Shop, allowing you to personalise your system.

Nintendo DSi Menu

Page 28 →



Nintendo DSi XL built-in software



DS Download Play

Page 64 →

Download and play certain multiplayer games and send and receive demos of certain software titles.



PictoChat™

Page 65 →

Send and receive wireless messages and drawings and chat with friends.



Nintendo DSi Browser

Page 68 →

A useful application that lets you browse the internet simply using your stylus.



Play with photos!

Nintendo DSi Camera

Page 32 →

Have fun playing with your photos using 11 amusing lenses.

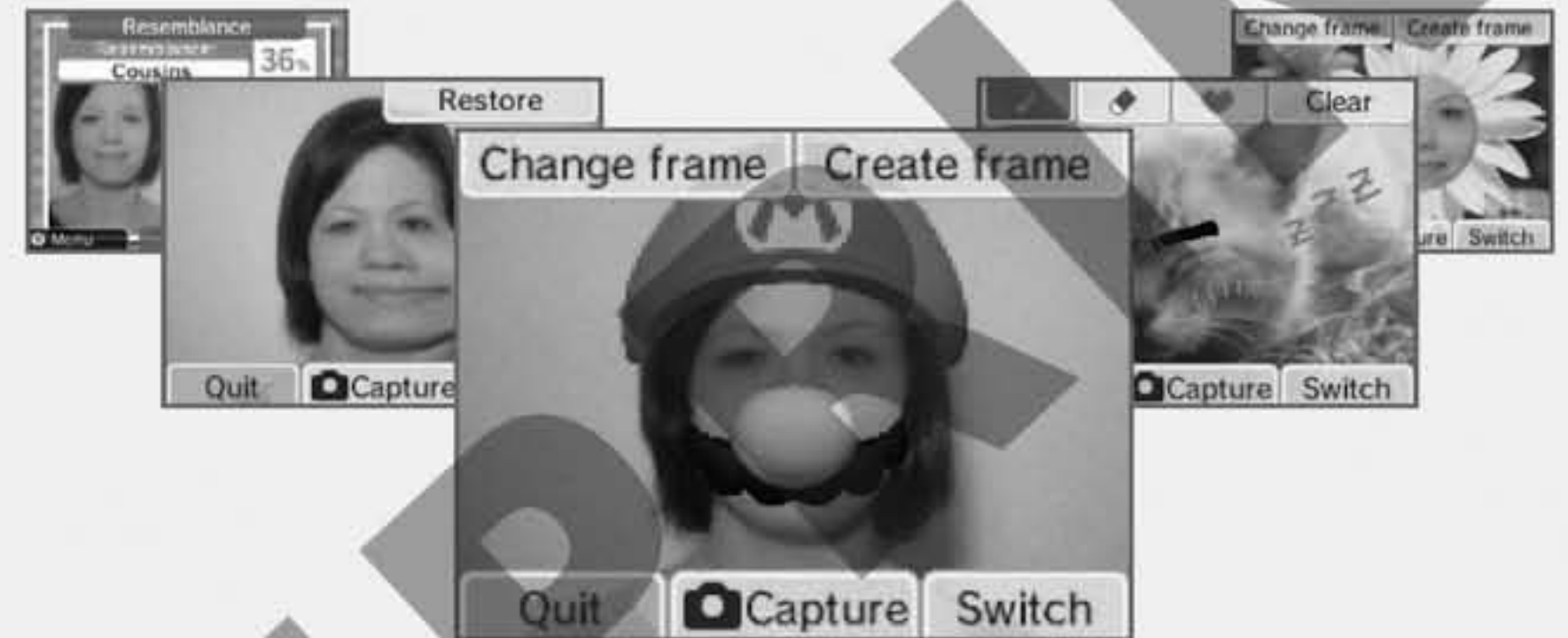

Play with sounds!

Nintendo DSi Sound

Page 51 →

Listen, watch, speak and touch with this audio player.

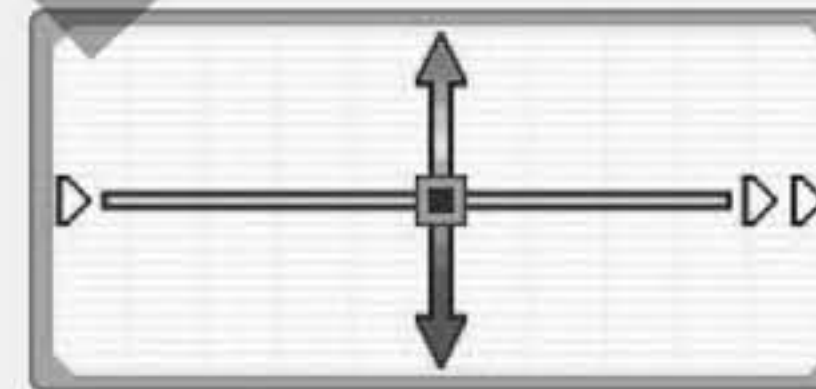

Change the pitch and speed

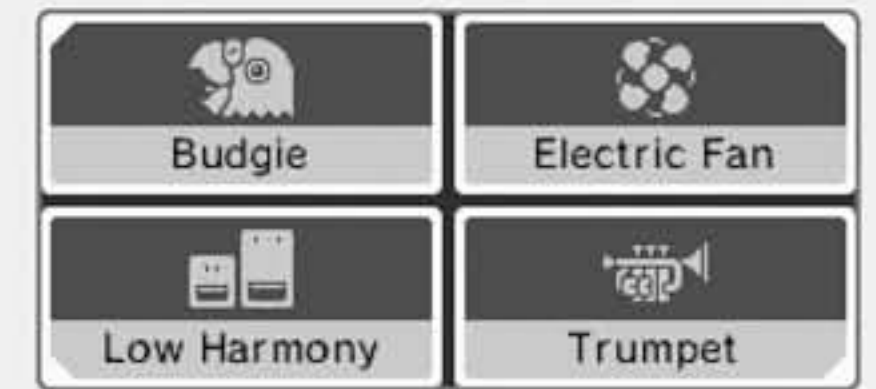

Manipulate recorded sounds



Enjoy Nintendo DSiWare!

Nintendo DSi Shop

Page 61 →

Find and purchase software and save it to your Nintendo DSi XL system.

Note: A broadband internet connection is required to make use of this service.



Purchase Nintendo DSiWare exclusively for your Nintendo DSi / Nintendo DSi XL system.

Let's get started

When the system is turned on for the first time, you have to configure the settings.

Follow the steps below to get started.

 Using the Touch Screen [Page 24 →](#)

■ Getting Started

 Charge the Battery Pak [Page 15 →](#)

 Turn the power on and configure the system [Page 26 →](#)

 Preferences can be adjusted later in the System Settings. [Page 70 →](#)

 **Loading Software!**
Inserting Game Cards and using software. [Page 31 →](#)

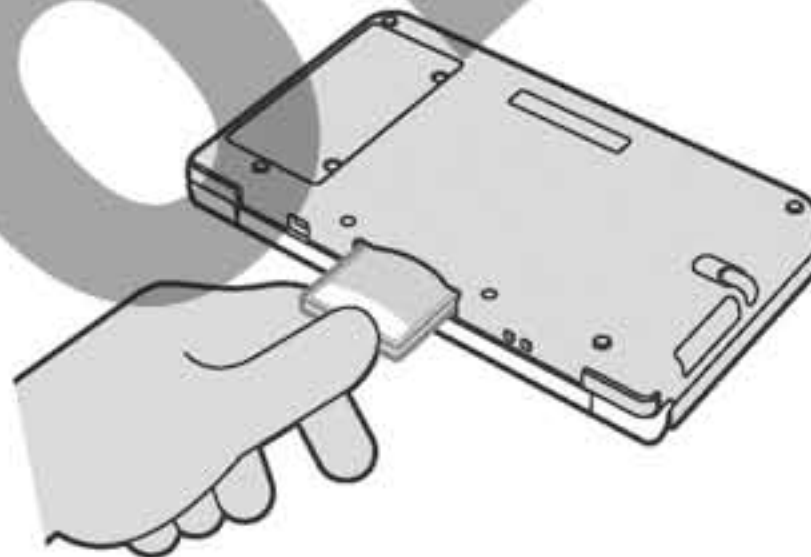

**Basics
section**

Page 8

**Applications
and Settings
section**

Page 23

**Support
and Trouble-
shooting
section**

Page 103

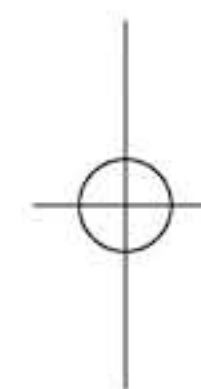

NOT FOR PREVIEW PRINT

Nintendo DSi XL Operations Manual







Basics

The following points are explained in this section of the Nintendo DSi XL Operations Manual.

- Component Names and Functions
- Charging the Nintendo DSi XL Rechargeable Battery Pak
- Replacing the Nintendo DSi XL Rechargeable Battery Pak

This section should be read in conjunction with the Applications and Settings section of the Nintendo DSi XL Operations Manual.

Contents

	Component Names and Functions	10
	Charging the Nintendo DSi XL Rechargeable Battery Pak	15
	Adjusting the Volume / Screen Brightness	18
	Using SD Memory Cards	19
	Replacing the Nintendo DSi XL Rechargeable Battery Pak	20
	Using the Nintendo DSi XL stylus/Nintendo DSi XL stylus (large) and Touch Screen	22

Component Names and Functions

Nintendo DSi XL system (UTL-001(EUR))

Front of the system

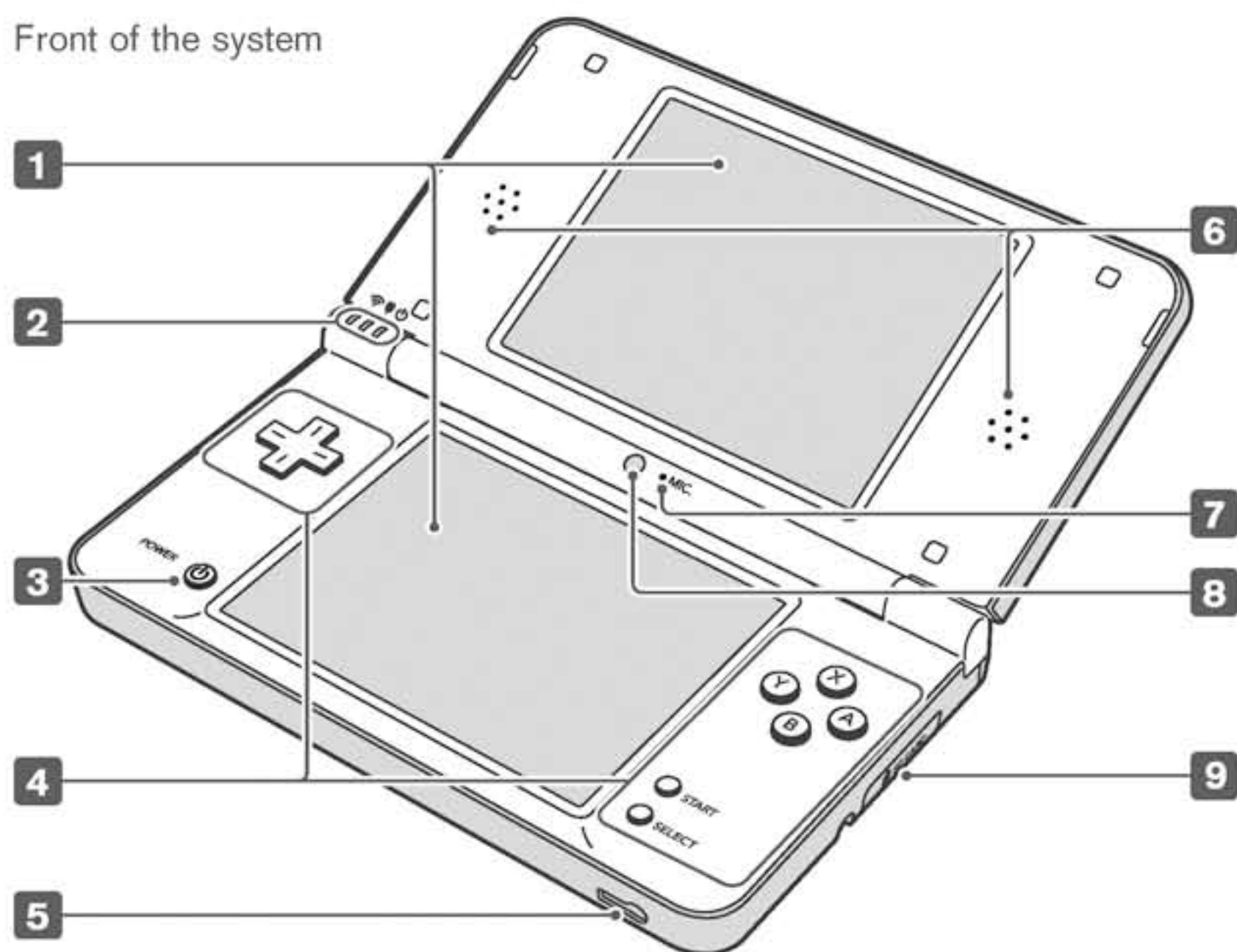

1 LCD screens

Twin backlit colour liquid crystal displays. The lower screen (the Touch Screen) is touch sensitive. Software which makes use of this control feature should be operated with the included Nintendo DSi XL stylus / Nintendo DSi XL stylus (large). The screen brightness can be adjusted to one of 5 levels. [Page 18 →](#)

CAUTION: When opening the Nintendo DSi XL, keep your fingers away from the hinge to avoid pinching them.

2 Wireless indicator LED Recharge indicator LED Power indicator LED

3 POWER Button

- When the power is off: Press to turn on the system.
- When the power is on: Press to reset the system and return to the **Nintendo DSi Menu**. Press and hold (0.5 seconds or more) to turn off the power.

4 Control Buttons

The **+** Control Pad, A, B, X and Y Buttons, and START and SELECT. Used for game play control. See the Instruction Booklet for the game you are playing for specific game control information.

5 Audio Jack

For connection of commercially-available stereo headphones, external microphones or headsets. When any of these are connected, no sound will be played through the speakers.

6 Speakers

7 Microphone (MIC.)

Used by games and software with microphone functionality.

8 Inner Camera

Used by games and software with camera functionality.

9 SD Memory Card Slot

For inserting SD Memory Cards (a.k.a. "SD Cards"), which are sold separately.

[Page 19 →](#)

Functions of Each LED

Indicates various system statuses, depending on the colour of each LED, and whether these LEDs are solidly lit or blinking.

Wireless Indicator LED

Lights up yellow when DS Wireless Communications are enabled for use. Dims when the system is in **Sleep Mode**.

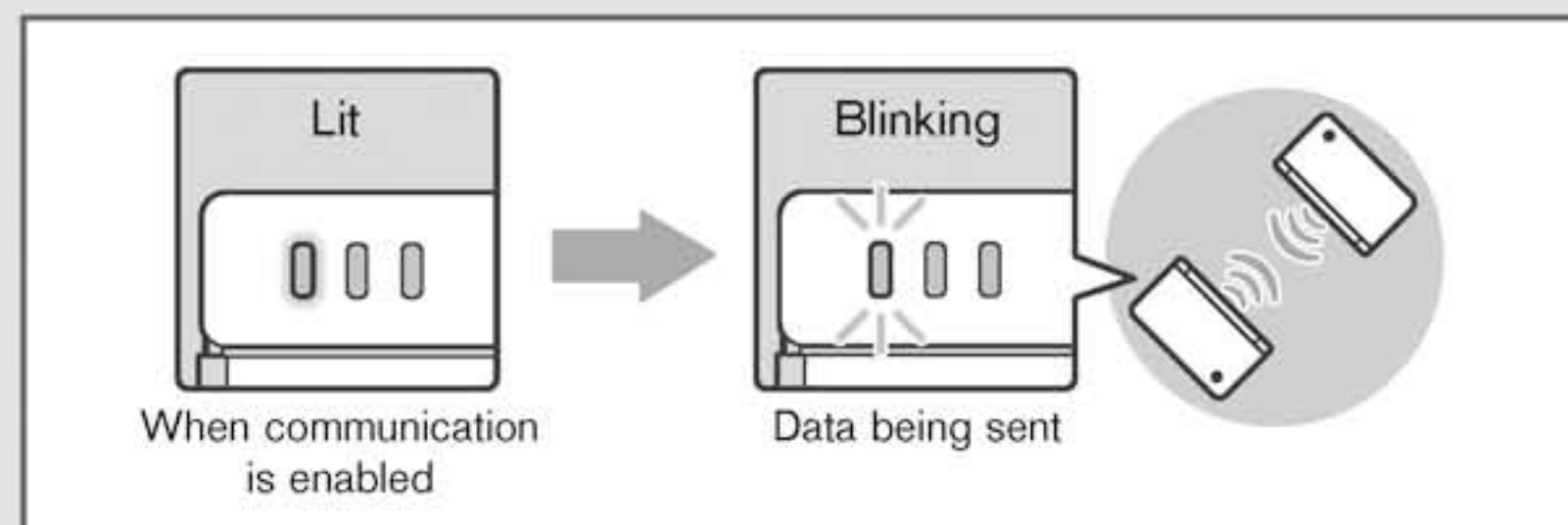

🔌 Recharge Indicator LED

Lights up orange when the battery is being charged.

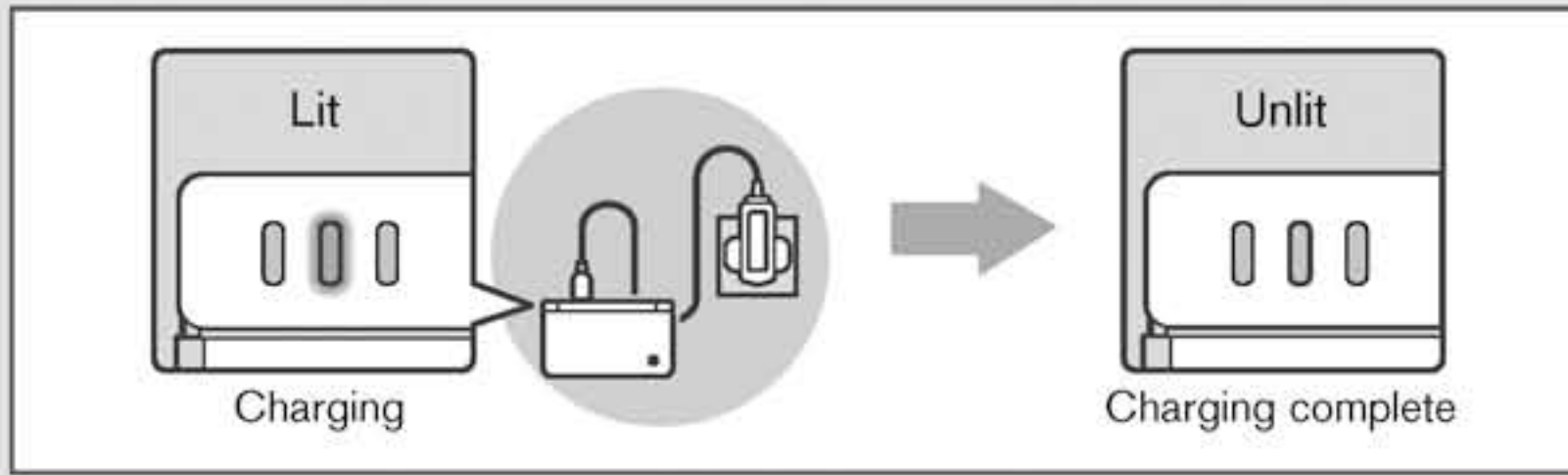

- If you play a game while the system is recharging, the recharge indicator LED may not always turn off once charging has completed. This is not a malfunction.
- If the recharge indicator LED is blinking, there is a chance that the Battery Pak has not been placed properly inside the battery compartment. Make sure it is placed correctly and connected properly. [Page 20 →](#)

🔌 Power Indicator LED

Lights up blue when the power is turned on. Lights up red when the remaining battery charge is low, and flashes when the battery is almost completely depleted.

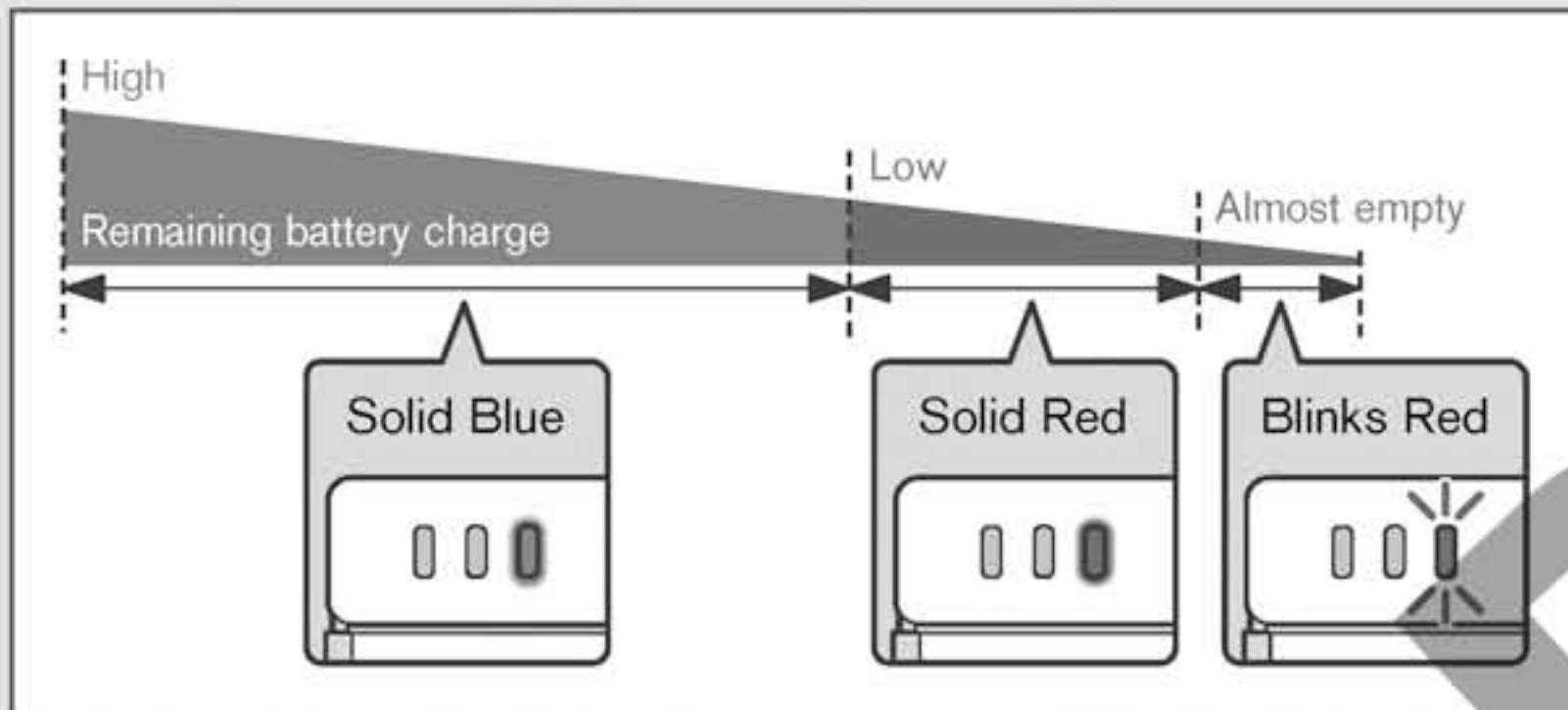

Note: If the power indicator LED is red, save your game quickly and recharge. If the battery charge runs out before you save, you may lose some data. If the LED slowly brightens and dims either blue or red, the battery is in **Sleep Mode**, which will conserve the battery charge.

Battery Life

The battery life will change depending on the brightness of the LCD screens. Battery life will also vary depending on factors such as the software being used and the ambient temperature. As such, these times should only be taken as rough estimates. Using the wireless communication or camera features may reduce the battery time below the figures shown to the right.

Note: The system is configured to the "High" brightness setting when shipped from the factory.

☀️ Highest	Approx. 4–5 hours
☀️ High	Approx. 6–8 hours
☀️ Medium	Approx. 9–11 hours
☀️ Low	Approx. 11–14 hours
● Lowest	Approx. 13–17 hours

Nintendo DSi XL system (Continued)

Back of the system

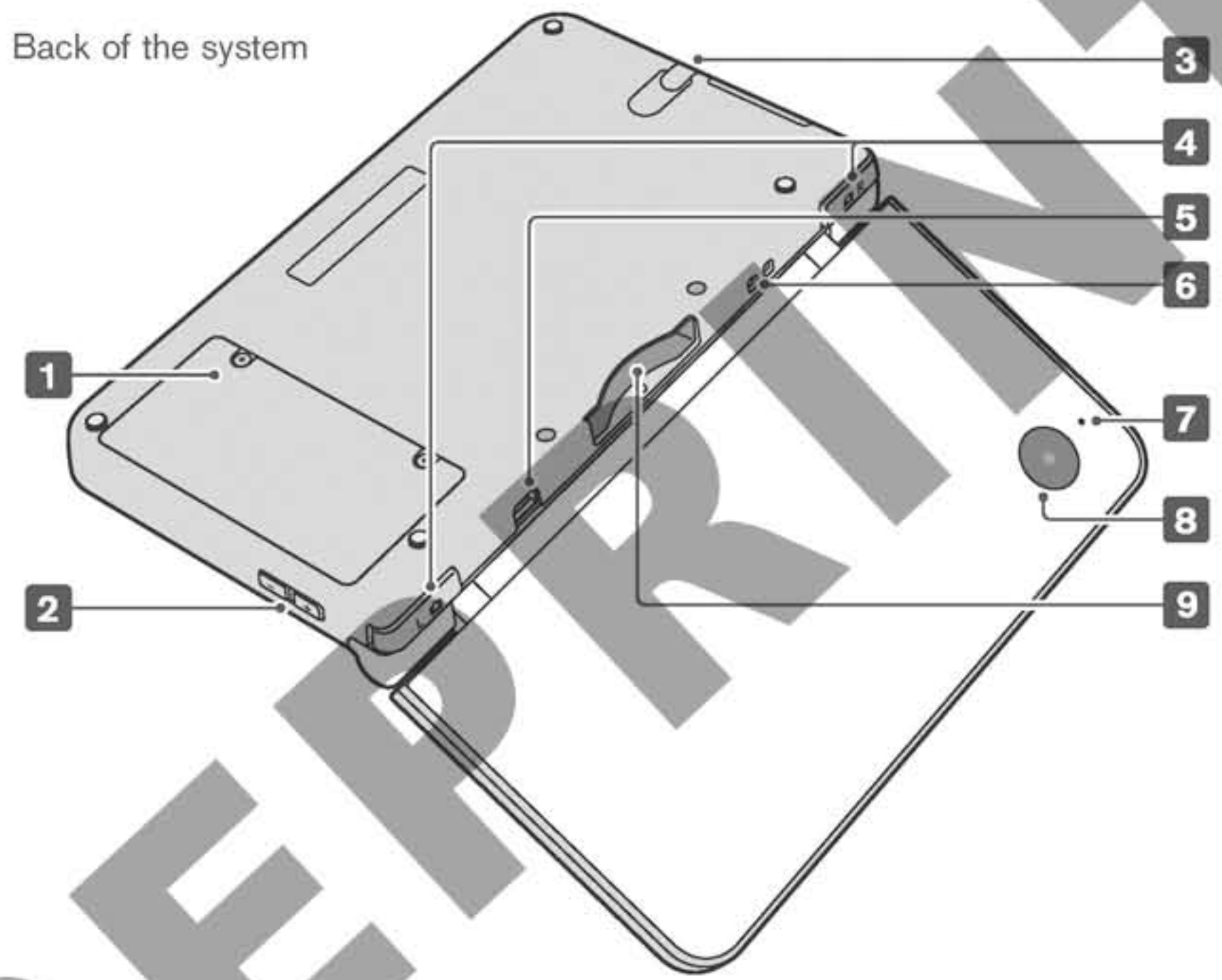

1 Battery Cover

Can be removed to replace the Rechargeable Battery Pak. See [Page 20 →](#) for more information on battery replacement.

2 Volume / Brightness Control

This adjusts the volume and brightness (in 5 levels). [Page 18 →](#)

3 Nintendo DSi XL Stylus Holder

Always place the Nintendo DSi XL stylus back into the stylus holder after use.

Note: Do not insert anything other than the official Nintendo DSi XL stylus (UTL-004) into the stylus holder. Doing so could damage the system or cause a blockage in the stylus holder.

4 Control Buttons (L Button, R Button)

5 Power Supply Connector

Allows connection of the Nintendo DSi Power Supply (included) for recharging the battery or operation of the Nintendo DSi XL system using household mains power. [Page 15 →](#)

6 Wrist Strap Attachment

For attachment of a wrist strap (sold separately).

7 Camera Indicator LED

This LED lights up when the outer camera is in use.

8 Outer Camera

9 Game Card Slot

For loading Nintendo DSi Cards, Nintendo DSi compatible Cards, and Nintendo DS Cards.

Nintendo DSi Power Supply (WAP-002(UKV))

This is the power supply used with the Nintendo DSi XL.

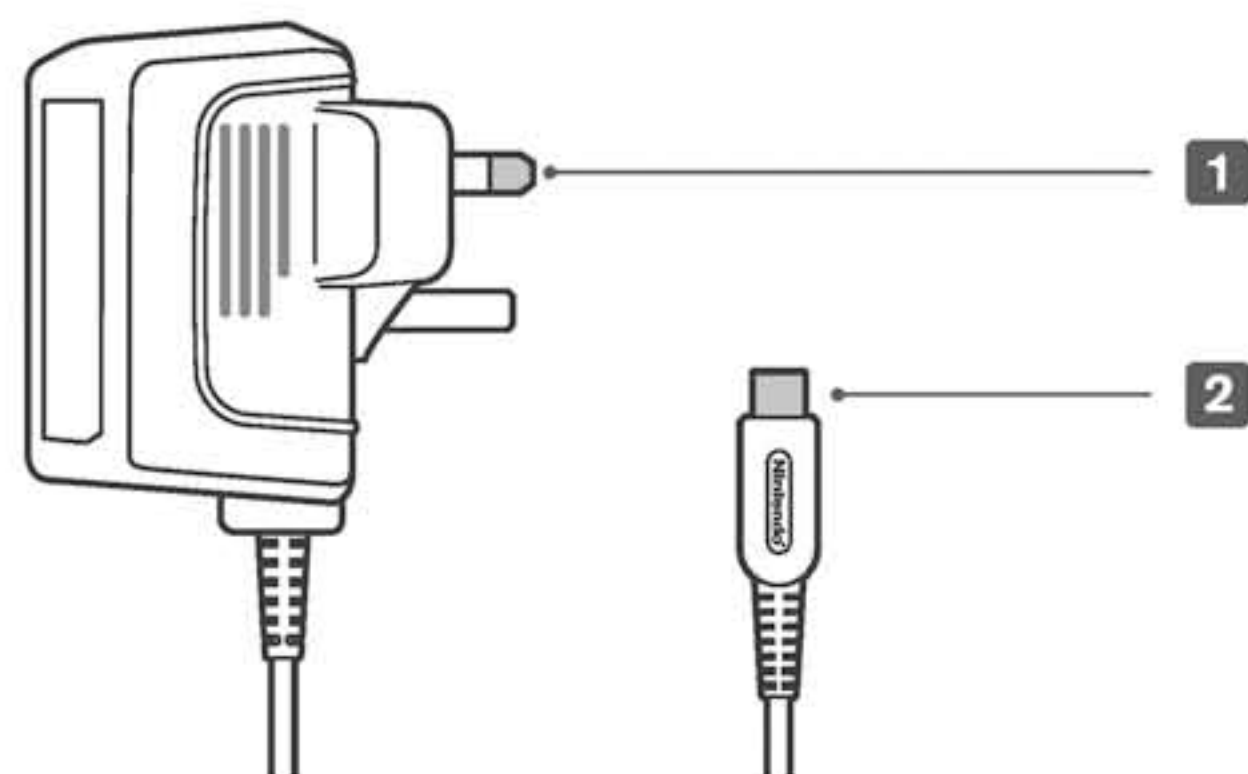

1 AC Plug

Plug for use in a standard 230-volt household electrical socket.

2 DC Plug

Connects to Power Supply connector for recharging the Battery Pak or when using household mains power.

Nintendo DSi XL stylus (UTL-004) / Nintendo DSi XL stylus (large) (UTL-005)

Styli used to control the system by directly touching the Touch Screen (lower screen).

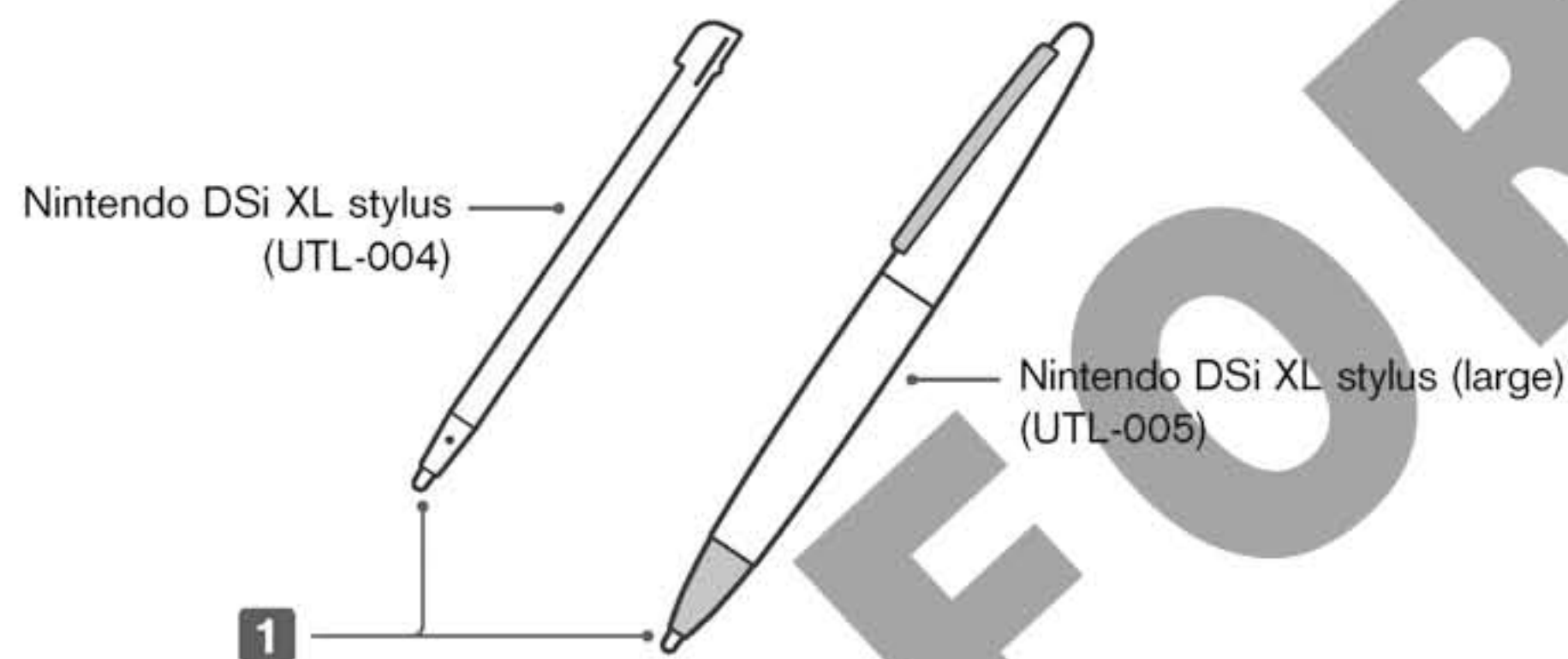

1 Stylus Tip

Place this end of the stylus against the Touch Screen when controlling the system.

The stylus (UTL-004) is shipped in the stylus holder on the side of the system. Make sure to return it to the stylus holder after use.

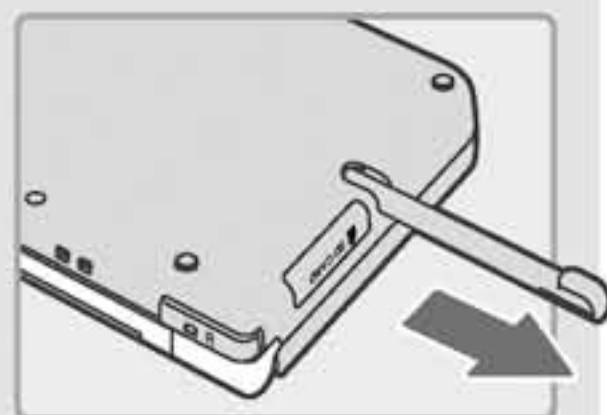

Charging the Nintendo DSi XL Rechargeable Battery Pak

CAUTION: Do not use the Nintendo DSi Power Supply during a lightning storm, as there may be a risk of electric shock from lightning.



Before you use the Nintendo DSi XL for the first time, or after you have not used it for a long time, you must charge the Battery Pak. (If the Nintendo DSi XL is not used for long periods of time, the battery should still be recharged at least once every six months.)

When fully charged, the battery will last from 13–17 hours on the lowest screen brightness setting, depending on the type of game activity. (See [Page 18](#) for information on adjusting the screen brightness.) On the brightest setting, the battery life is 4–5 hours.

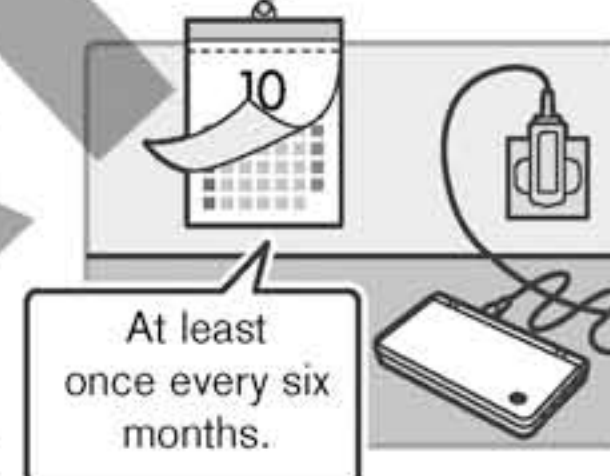

The Battery Pak can be recharged approximately 500 times, but performance may decrease after repeated recharges, depending on usage conditions such as temperature. (Optimal charging temperature is between 5 and 35 degrees Celsius.) Battery life may also decrease over time. After 500 recharges, battery life may be only 70% of the battery life at the time of purchase.



It takes approximately three hours to recharge the Battery Pak. (The actual time varies depending on how much battery life you have left.) When the power indicator LED turns red, save your game and recharge the battery to prevent loss of game data. You can play games while recharging the battery, but the recharge time will be longer.

IMPORTANT: The Nintendo DSi Power Supply (WAP-002(UKV)) is only for use with Nintendo DSi/Nintendo DSi XL systems. It is not compatible with any other Nintendo system.



Charge the batteries when the ambient temperature is between 5–35 degrees Celsius. Attempting to charge the Battery Pak when the ambient temperature is outside this range may degrade the Battery Pak and prevent it from charging. If the ambient temperature is low, the batteries may not charge completely.

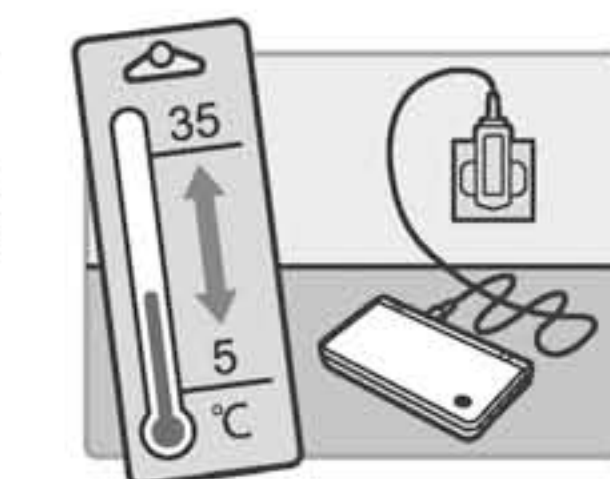

If you feel the usage time has dropped off noticeably, replace the Battery Pak. Replacement Battery Paks are sold separately. Please contact your Nintendo Service Centre for further information on where to purchase a replacement. [Page 119](#)

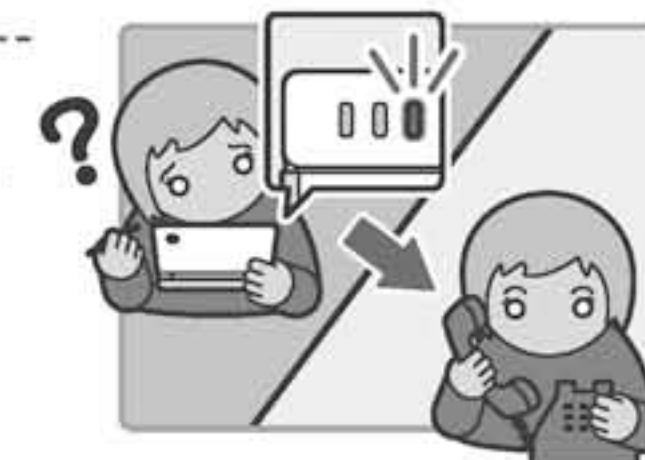

Charging the Nintendo DSi XL Rechargeable Battery Pak

- 1 Insert the DC plug from the Power Supply into the Power Supply connector on the back of the Nintendo DSi XL.

IMPORTANT: Be sure the DC plug is facing in the correct direction before inserting into the Power Supply connector to avoid damaging either the DC plug or Power Supply connector.

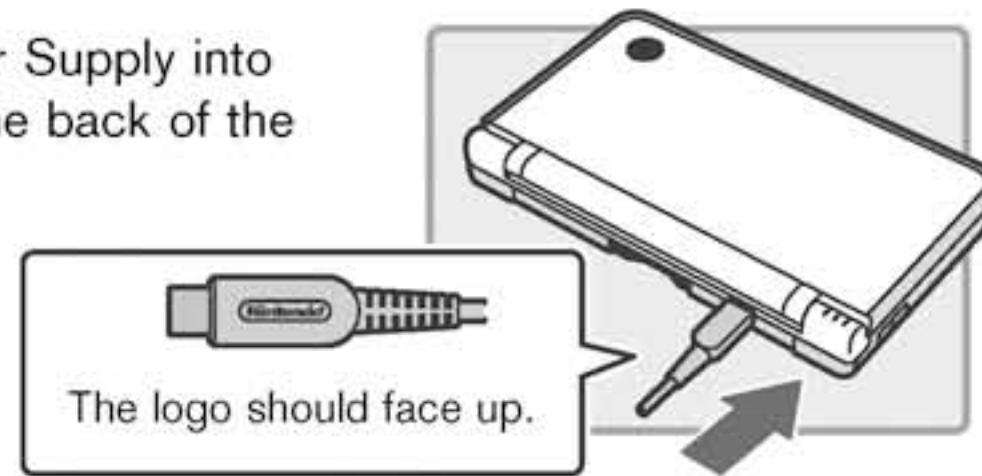

- 2 Insert the AC plug of the Power Supply into a standard 230-volt AC wall socket. Be sure that the pins are fully inserted into the socket. The recharge indicator LED will light up orange until the battery is fully charged. You can use the Nintendo DSi XL while recharging; however, it will take longer to recharge the battery. When you use the Nintendo DSi XL while recharging, the recharge indicator LED may remain on even when charging is complete. This is not a malfunction.

- If the recharge indicator LED is not lit, make sure the Power Supply is connected properly to both the system and the wall socket.
- If the recharge indicator LED is blinking, there is a chance that the Battery Pak has not been placed properly inside the battery compartment. Make sure it is placed correctly and connected properly.

Page 20 →

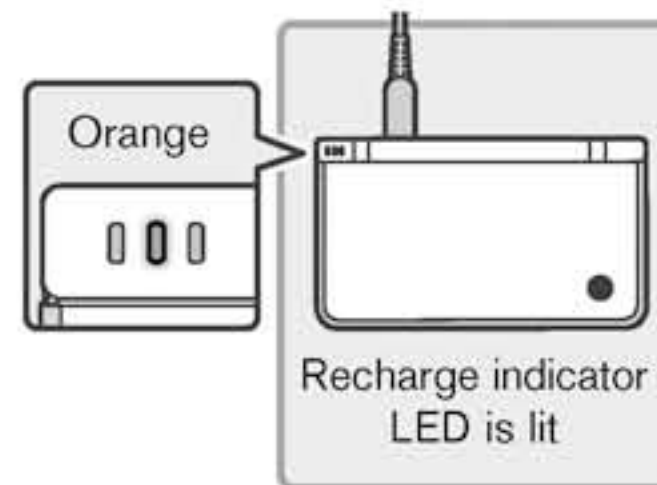
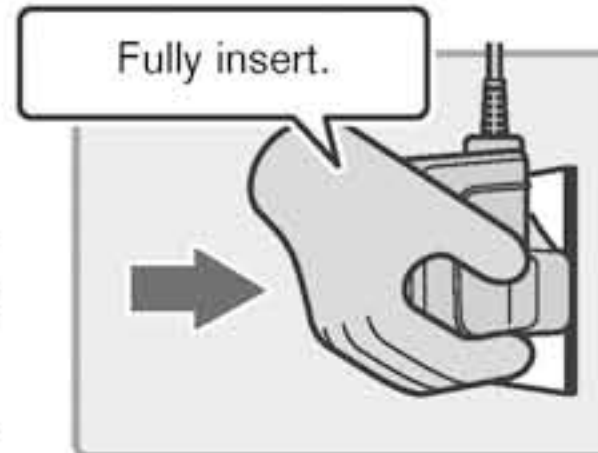

- 3 Wait until charging has completed.

- 4 When fully charged, the recharge indicator LED will turn off. Remove the Power Supply from the wall socket. Then remove the DC plug from the Power Supply connector.

IMPORTANT: When disconnecting any plugs from the Nintendo DSi XL or wall socket, carefully pull by the plug itself rather than by the cord. Do not wrap the Power Supply cord around the Nintendo DSi XL system.

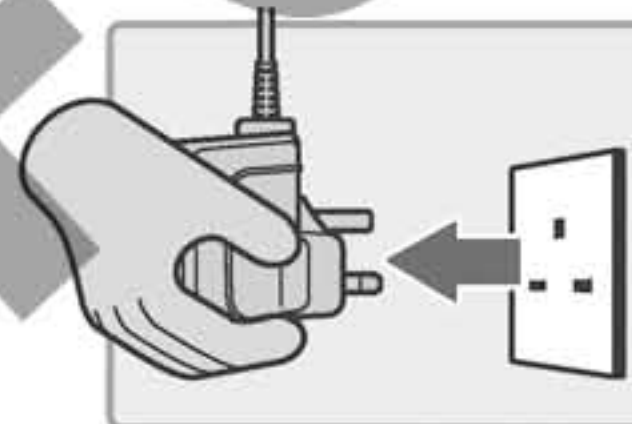
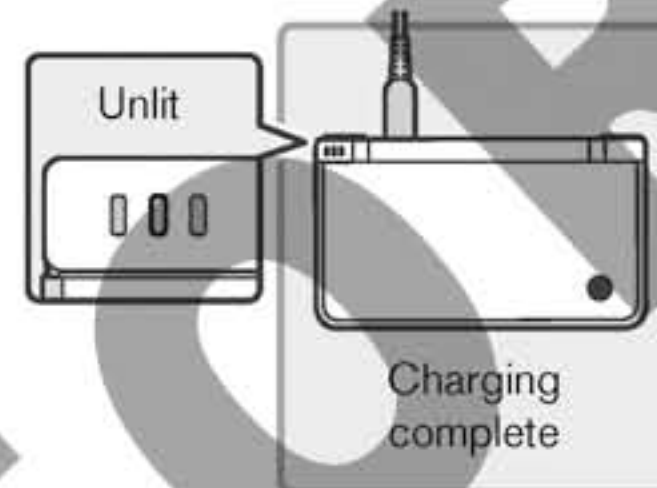

- 5 Hold the Power Supply's DC plug and unplug it from the system.

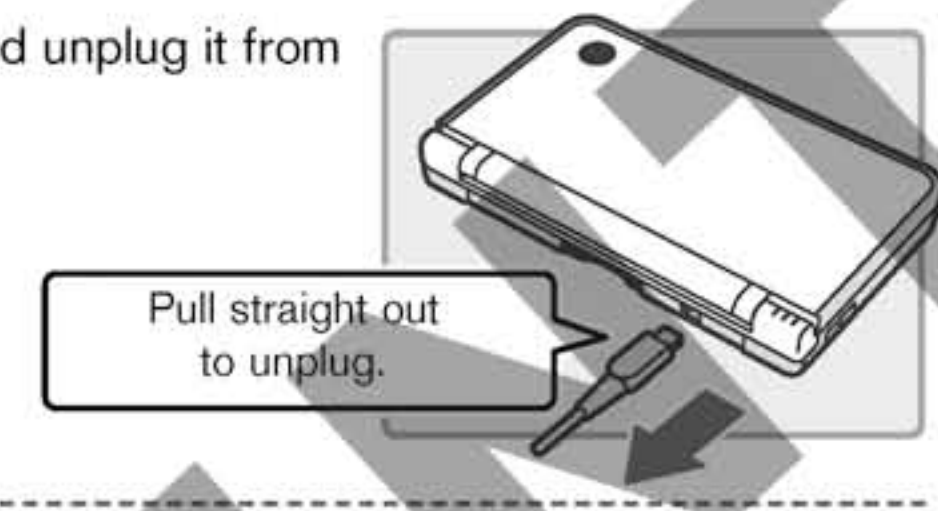

- The Nintendo DSi XL system is designed to be used safely with the Nintendo DSi Power Supply (WAP-002(UKV)).
- The Power Supply conforms to Low Voltage Directive (2006/95/EC).
- The Power Supply should be regularly examined for damage to the cord, plug enclosure and other parts.
- In the event of damage the Power Supply must not be used until the damage has been repaired.
- The Nintendo DSi XL is not intended for children under 3 years old.
- The Power Supply is not a toy.
- The Power Supply is for indoor use only.
- If the external flexible cable or cord of the Power Supply becomes damaged, it should be replaced by the Nintendo Service Centre in order to avoid any potential hazards.
- The Nintendo DSi XL should be disconnected from the Power Supply before cleaning.
- Please note that the device and, in particular, the battery must be kept out of reach of very young children.
- Do not use the Power Supply in places where it may be splashed with water or any other liquids, i.e. juice, pet urine or oil, or in extremely humid places.
- Ensure that you are using a 230V power socket. If not, use a transformer to change the power voltage to 230V. When using a 230V power socket, do not use travel transformers or incandescent-specific light dimmers because they may change the voltage. Use of the Power Supply with the incorrect voltage may cause damage to your Power Supply and Nintendo DSi XL system.

Adjusting the Volume / Screen Brightness

Adjusting the Volume

1 Press the volume / brightness control.

Press the + side to increase the volume.
Press the - side to decrease the volume.

- The camera's shutter sound will always be played at a fixed volume, regardless of the current setting of the volume control.
- When the system is in **Sleep Mode**, the volume can be decreased but not increased.

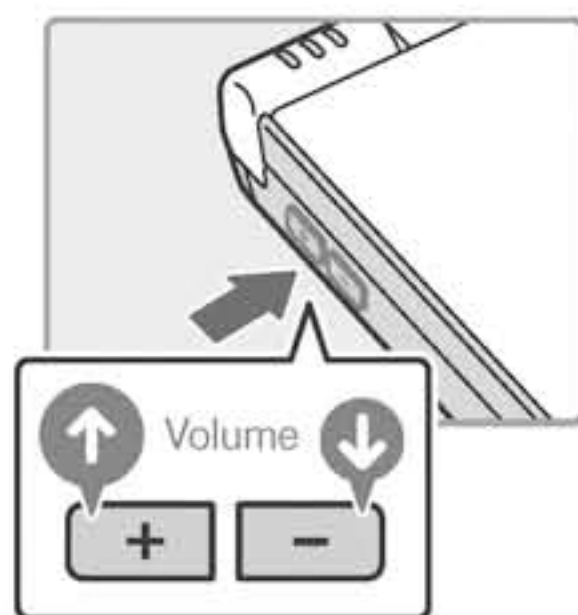

How to start the system with low (muted) volume

Turn the power on while holding down the - side of the volume / brightness control.



Adjusting the Screen Brightness

1 Press and hold SELECT.

2 Press the volume / brightness control.

Press the + side to increase the brightness.
Press the - side to decrease the brightness.

- Changing the screen brightness will also change the brightness of the power indicator LED and the wireless indicator LED.
- Increasing the screen brightness will increase the power consumption. The power indicator LED may change from blue to red as a result of the screen being made brighter. Note that the battery may run out and the system may lose power shortly after the power indicator LED becomes red.

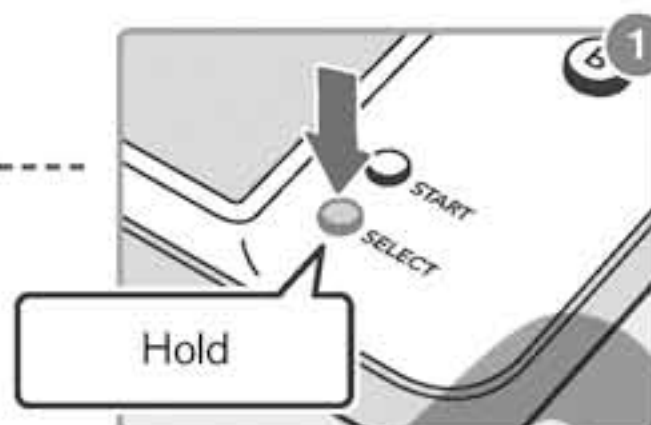

The relationship between screen brightness and battery duration

Increasing the screen brightness will reduce battery life. Decreasing the screen brightness will increase battery life. Adjust the brightness to the level you are most comfortable with. [Page 12](#) →

Using SD Memory Cards

Using an SD Card (sold separately) allows you to do the following:

- Back up data for photos taken with Nintendo DSi Camera.
- Play sound files saved in AAC-encoded format.
- Back up downloadable software and its save data.

Note:

- It may not be possible to copy some software or parts thereof.
- Data copied to SD Cards cannot be used on other systems.
- Save data on Game Cards cannot be copied.

Precautions about the use of SD Cards

- The Nintendo DSi XL supports high-capacity SD Cards over 2 GB in size ("SDHC Cards").
- An "SD Card adapter" is required to use miniSD or microSD Cards. When using a card adapter, be sure to remove the entire adapter (not just the card). Malfunction, or damage to the system or your data could result if the card adapter is left in the system.

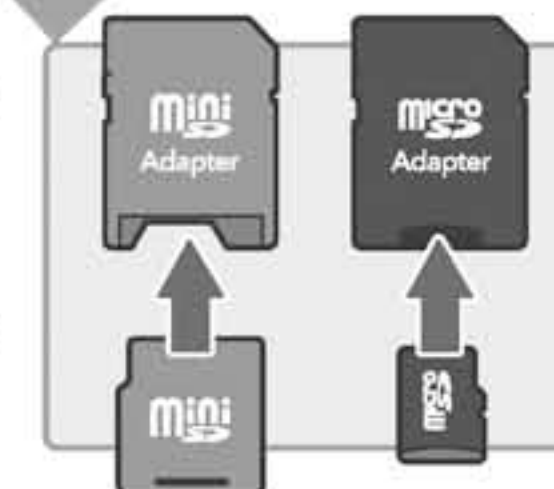

How to Insert

1 Open the SD Card slot cover.

Note: Do not pull or twist the slot cover forcefully. Doing so could stretch or deform it, which could make the cover impossible to close.

2 Insert the SD Card into the SD Card slot, and push it gently but firmly until it clicks into place, then replace the slot cover.

Note: The label should face towards the bottom of the system.

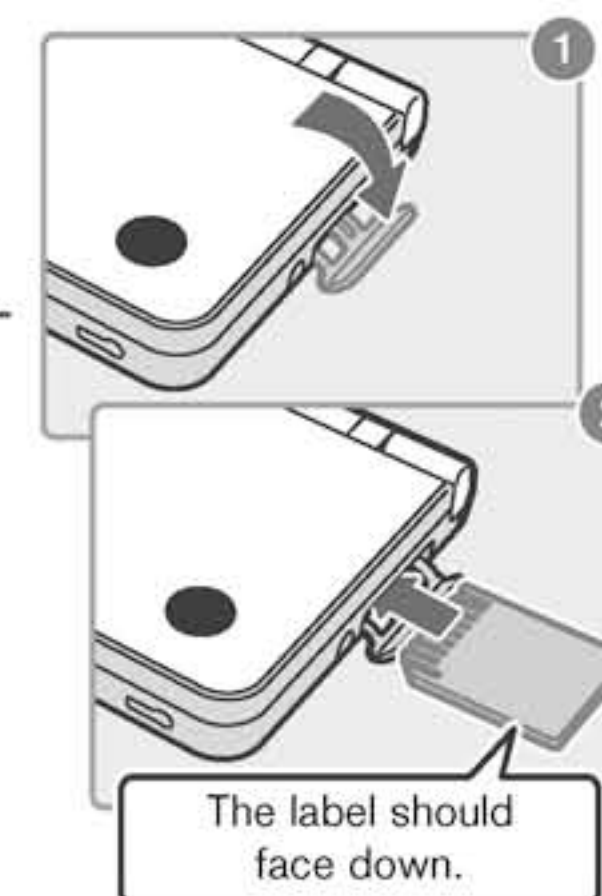

How to Remove

1 Open the SD Card slot cover and press on the SD Card until it makes a clicking sound.

2 Take hold of the SD Card, remove it and then close the slot cover.

Note: Do not remove the SD Card while the system is reading or writing data. This could damage the system or the SD Card and destroy data.

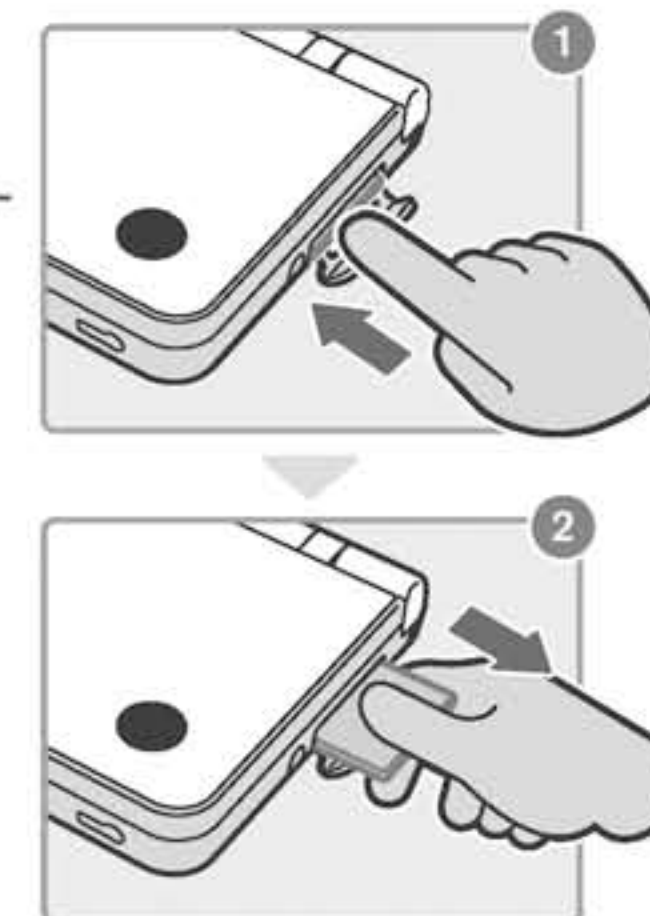



Replacing the Nintendo DSi XL Rechargeable Battery Pak

If it becomes necessary to replace the Battery Pak, follow this procedure. Replacement Battery Paks are sold separately. Please contact your Nintendo Service Centre for further information on where to purchase a replacement. If you do not want to replace the Battery Pak on your own, you may send your Nintendo DSi XL system to the Nintendo Service Centre to have the Battery Pak exchanged by an authorised technician.

A parent or guardian should replace the Battery Pak if a young child is using the system.



- 1 Always turn the power off and disconnect the Power Supply before replacing the Battery Pak.

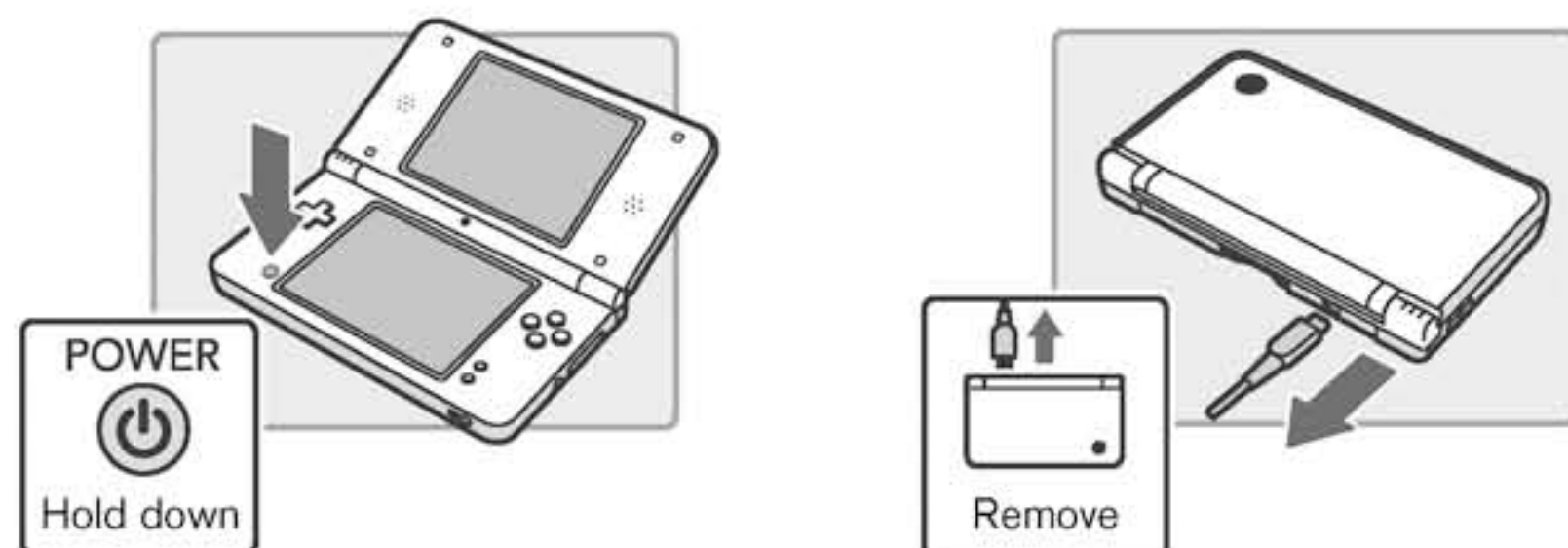

- 2 Using a screwdriver, loosen the screws on the battery cover. Remove the battery cover and retain. Always use an appropriate screwdriver for the screw. Using the wrong screwdriver may damage the head of the screw and you will not be able to remove the battery cover.

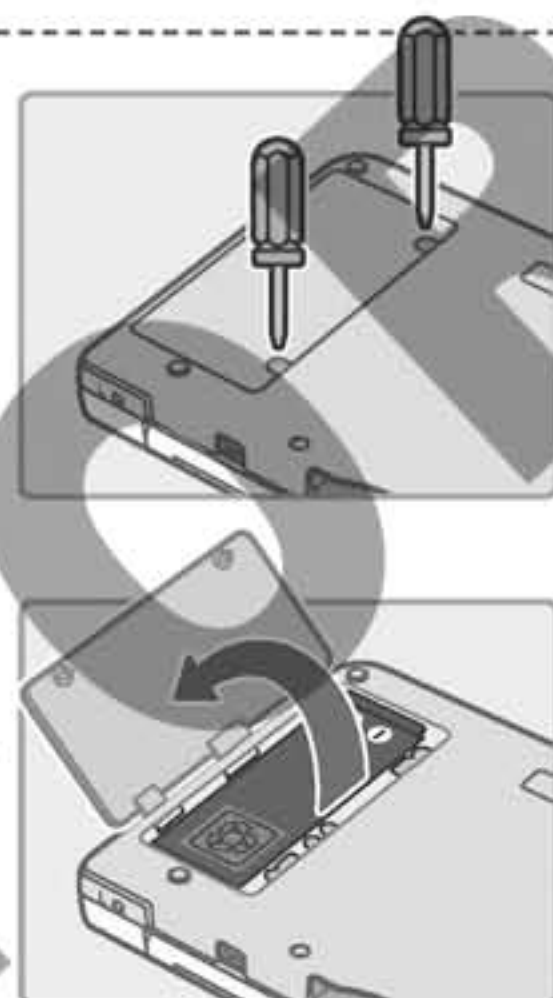

- 3 Use the protruding tab at the end of the Battery Pak to remove it from the Nintendo DSi XL.



- 4 Insert a new Battery Pak into the Nintendo DSi XL. Use only a new Nintendo DSi XL Battery Pak (UTL-003), which is a lithium-ion battery designed only for use with the Nintendo DSi XL system (UTL-001(EUR)). Make sure to insert the new Battery Pak correctly, as shown in the illustration.

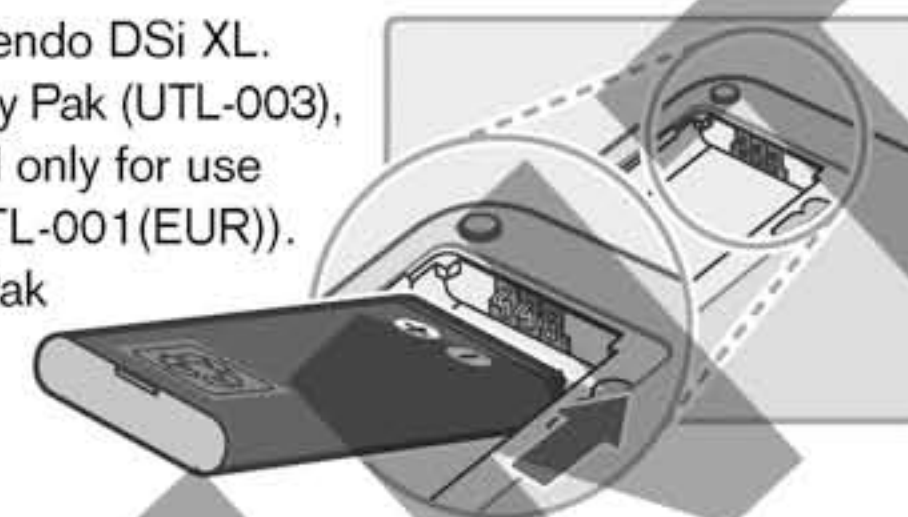

- 5 Replace the battery cover in its original position and carefully tighten the screws.

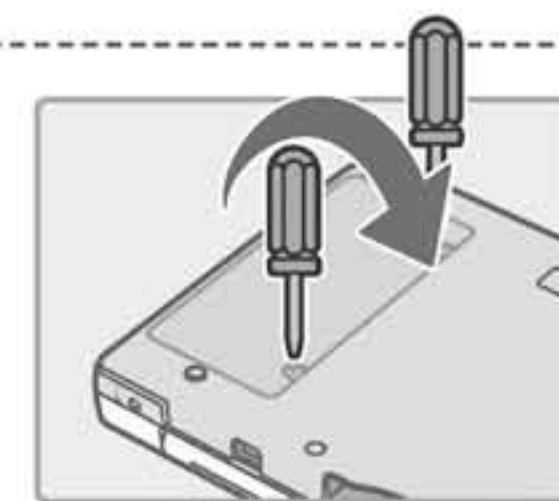

- 6 When disposing of the Rechargeable Battery Pak, please refer to the "Battery Disposal" information below.

Battery Disposal

- Discarding batteries in your general household waste can be harmful to the environment. When disposing of the Battery Pak, follow appropriate local guidelines and regulations.
- In accordance with the Directive on Batteries and Accumulators and Waste Batteries and Accumulators (2006/66/EC), battery collection and recycling schemes should be in place in all EU Member States since 26 September 2008. If these schemes are available in your country, the Battery Pak should not be disposed of in your general household waste. For further information contact your local solid waste authority.



Using the Nintendo DSi XL stylus/Nintendo DSi XL stylus (large) and Touch Screen

The lower screen, or Touch Screen, is touch sensitive. For Nintendo DS games that include this game control feature, operate the screen by using the included Nintendo DSi XL stylus / Nintendo DSi XL stylus (large). Lightly touch or slide the stylus across the Touch Screen.

Important Nintendo DSi XL stylus / Nintendo DSi XL stylus (large) and Screen Guidelines

- When operating the Touch Screen, please be sure to only use the Nintendo DSi XL stylus and Nintendo DSi XL stylus (large).
- Use only enough pressure to operate the game. Excessive pressure may damage the Touch Screen.
- Do not press on or slide the stylus across the upper screen.
- Do not use the stylus if it is broken.
- Place the Nintendo DSi XL stylus back in the stylus holder when not in use.

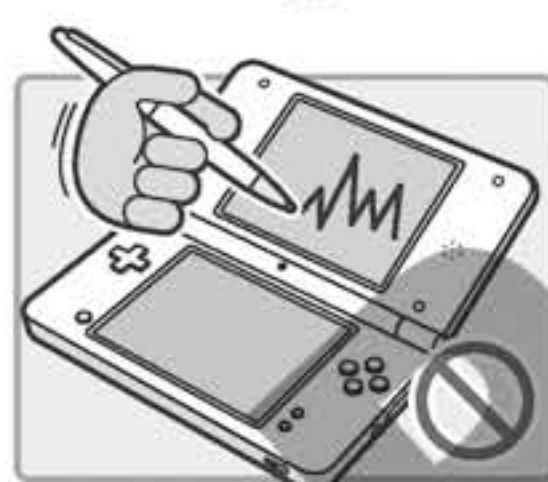
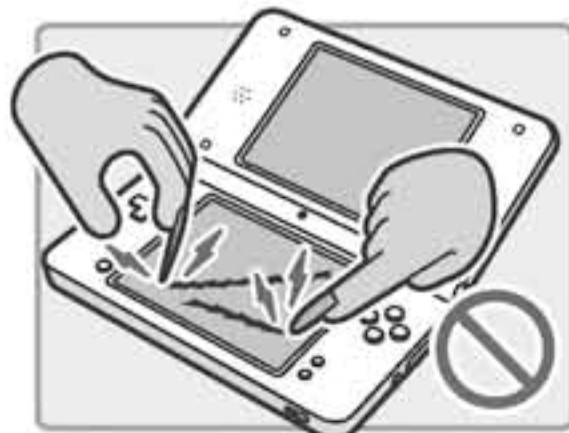

Screen Cleaning Procedure

If the screens on your Nintendo DSi XL system have visible smudges, fingerprints on them or are contaminated with foreign material, they may not work properly and could become damaged. You can clean them by using a soft, clean cloth such as a lens cleaning cloth.

- 1 Slightly dampen the cloth with water **ONLY** and wipe the screens to loosen any dirt or foreign material.
- 2 Wipe the screens with a dry cloth. If needed, repeat the cleaning process. If the Touch Screen still does not work after cleaning, please contact the Nintendo Service Centre.

NINTENDO DSⁱ XL

Nintendo DSi XL Operations Manual

Applications and Settings

The following points are explained in this section of the Operations Manual.

- Operating the Nintendo DSi Menu
- Built-in software
- System Settings
- Internet connection and settings

This section should be read in conjunction with the Basics section.

Note: Refer to the Support and Troubleshooting section if you think your product might be broken.

Operating the Touch Screen

Use the stylus and the Touch Screen to operate the various menus and built-in software on the Nintendo DSi XL.

In this manual two terms are used to describe the use of the stylus on the Touch Screen.

Touch

Lightly pressing the stylus against the Touch Screen is known as "touching".

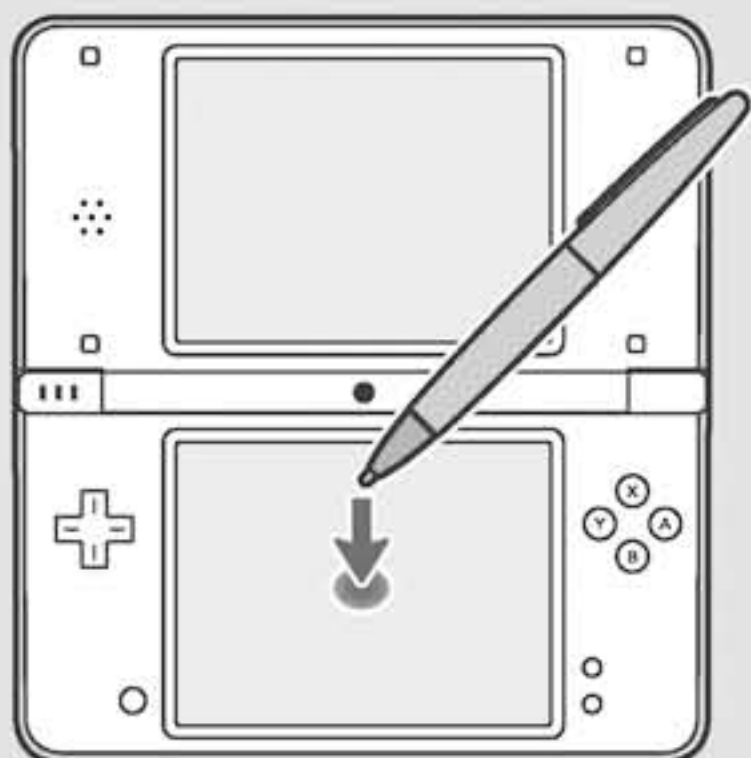

Slide

Placing the stylus against and moving it over the surface of the Touch Screen is known as "sliding".

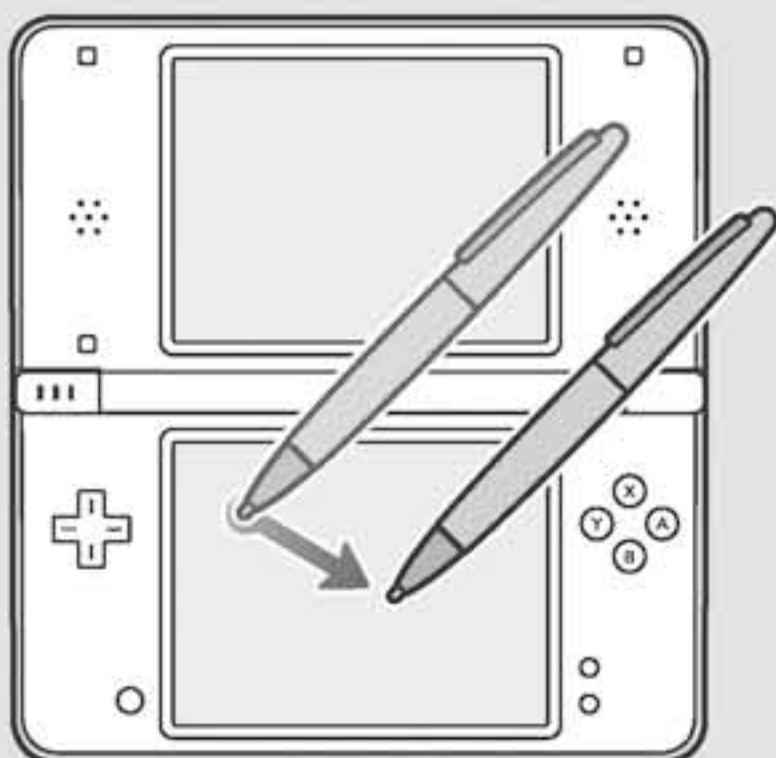

When you cannot operate the Touch Screen properly

You can start the Nintendo DSi XL system on the **Touch Screen Calibration Screen** by taking the following steps when turning on the power. Try this if you are having trouble operating the Touch Screen.



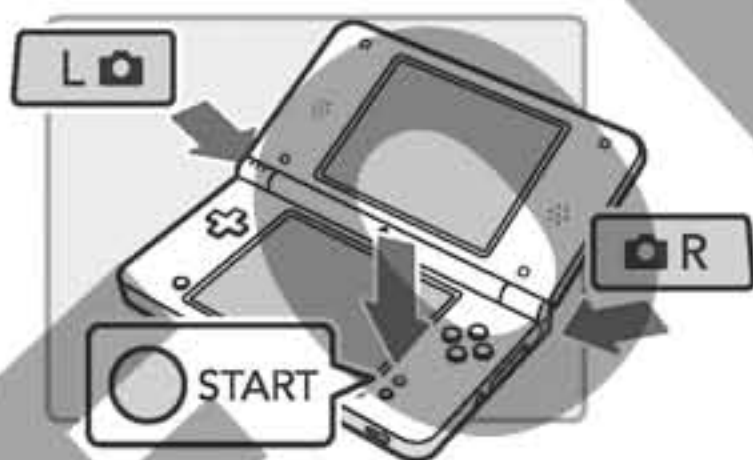

- 1 Press and hold L Button + R Button + START.

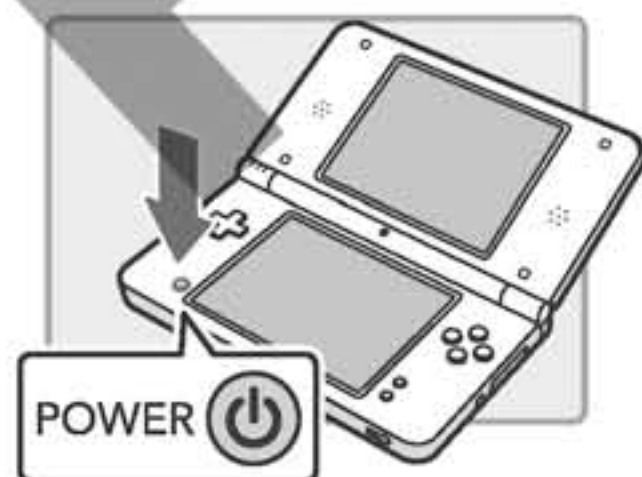

- 2 Press the POWER Button.



Contents

	Turning the power on and off	26
	Nintendo DSi Menu	28
	Screen Layout Explanation	28
	Camera Mode	30
	Using Game Cards	31
	Nintendo DSi Camera	32
	Getting Started	33
	Using the Cameras	34
	Viewing the Album	44
	Options (Exchanging Photos/Frames, Copying, Deleting)	46
	Calendar	50
	Nintendo DSi Sound	51
	Starting Nintendo DSi Sound	51
	Recording and Playing with Sounds	52
	Playing with Music on an SD Card	57
	Settings	60
	Nintendo DSi Shop	61
	What are Nintendo DSi Points?	61
	How to Redeem Nintendo DSi Points	62
	DS Download Play	64
	Using DS Download Play	64
	PictoChat	65
	Starting PictoChat	65
	Controls	66
	Nintendo DSi Browser	68
	Nintendo DSi Browser Instruction Manual	68
	System Settings	70
	System Settings	70
	Data Management	72
	DS Wireless Communications/Brightness Settings	73
	Profile	74
	Date/Time/Alarm	75
	Parental Controls	76
	Touch Screen Calibration/Mic Test	81
	Internet	82
	System Update/Format System Memory	98
	Using the Keyboard	99
	Others	100
	Glossary	100
	Error Messages and Error Codes	102

Turning the power on and off

Powering Up

Press the POWER Button and the power indicator LED will light up, indicating that the system has been turned on. (To turn the system off, press and hold the POWER Button for half a second or more.)

Note:

- If the POWER Button is pressed (not held down) while the system is on, a reset will be performed.
- For information about the power indicator LED and battery life see [Page 12](#).

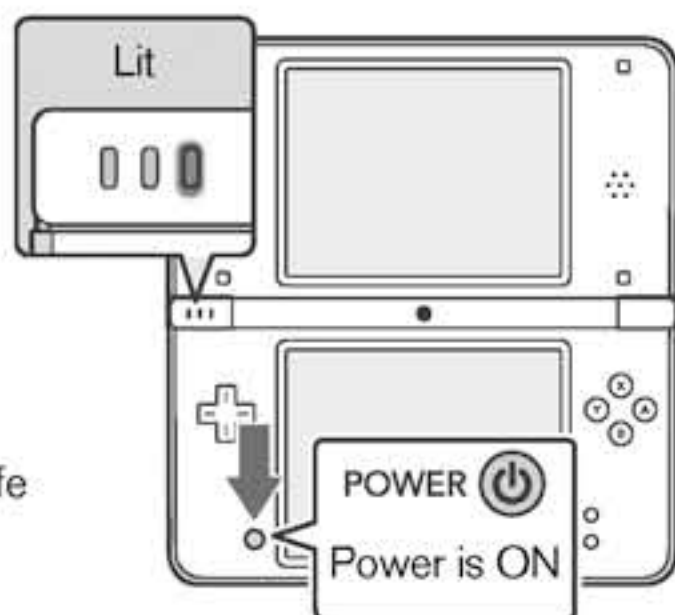

Turning the power on for the first time

Follow the step by step guide shown below to configure the settings.

- 1 Touch OK.



- 2 Touch your language then touch OK.



- 3 Touch your country of residence then touch OK.



- 4 Touch to set the date then touch OK.



- 5 Touch to set the time. Touch OK.



- 6 Touch the keyboard and enter a name. Touch OK.

Note: The maximum length for a user name is 10 characters. For information about the keyboard see [Page 99](#).



- 7 Touch the keyboard and enter a message. Touch OK.

Note: The maximum length for a message is 26 characters. For information about the keyboard see [Page 99](#).



- 8 Touch to set your birthday. Touch OK.



- 9 Touch a colour of your choice. Touch OK.

Note: This colour will be used in various places, such as the **Nintendo DSi Menu**.

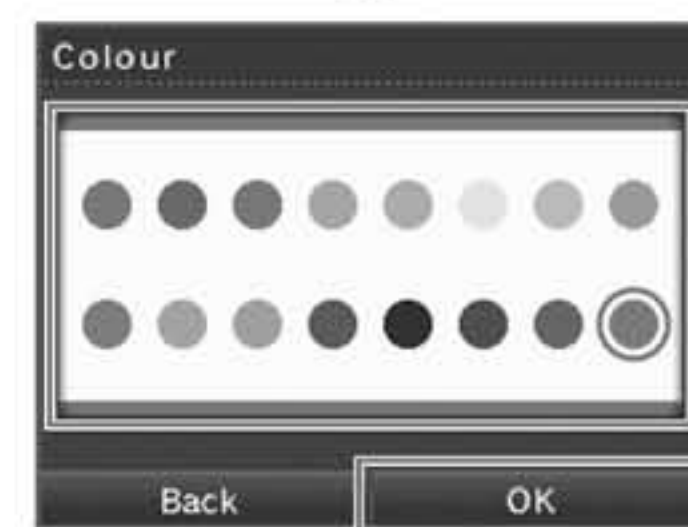

- 10 Touch QUIT. (To configure Parental Controls, touch SETTINGS. See [Page 76](#).)

Note: Parental Controls settings allow parents or guardians to manage what content can be used or downloaded on the Nintendo DSi XL system.

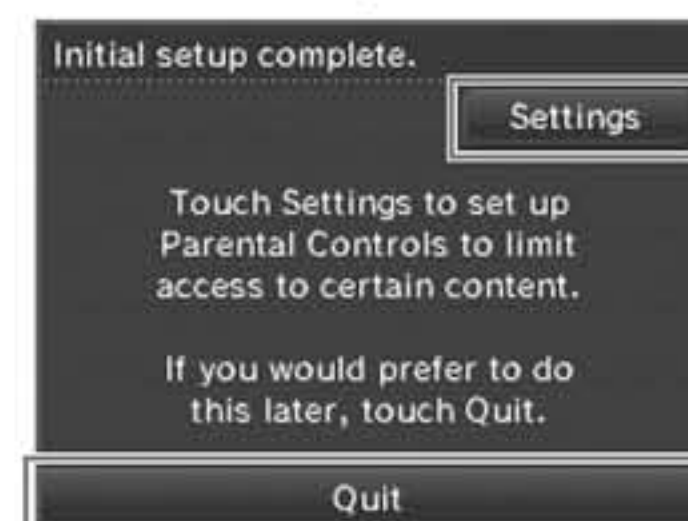



Nintendo DSi Menu

The **Nintendo DSi Menu** appears automatically when you turn the system's power on. On this menu you will see icons for the system's built-in applications and for any Nintendo DS Card, Nintendo DSi compatible Card or Nintendo DSi Card inserted into the Game Card slot. Touch these icons to play games, use the applications or enter **SYSTEM SETTINGS**. You can also press the L Button or R Button to enter **Camera Mode** and take photos.

Screen Layout Explanation

The screenshot shows the Nintendo DSi Menu interface. At the top, it displays the user's name (NINTE JOHN) and the date and time (03/04 10 00). Below this is a volume level indicator and a battery charge indicator. The battery charge indicator shows a bar with levels: Full, Low, Almost empty (flashing), and Charging. In the center, there is a user-taken photo of a cat. Below the photo, the application name "Nintendo DSi Camera" is displayed. At the bottom, there is an application list with icons for various applications, including the Camera icon which has a "START" button below it. Labels point to various elements: "User name", "Date & time", "Volume level", "Battery charge", "User-taken photo", "Application name", "Start icon", "Touch the application shown here to start it.", and "Application list".

Use the stylus or the **+**Control Pad to scroll through applications.

Application list: Here are the icons you'll see on the application list.

Card Software Icons



This icon appears when there's no Game Card inserted in the Game Card slot.



When a Game Card is inserted in the Game Card slot, an icon for that game will appear.

The icon for **THE LEGEND OF ZELDA™: PHANTOM HOURGLASS** is shown here.

Built-in Application Icons

These are the icons of the system's built-in software applications.



System Settings **Page 70 →**



Nintendo DSi Camera **Page 32 →**



Nintendo DSi Sound **Page 51 →**



Nintendo DSi Shop **Page 61 →**



DS Download Play **Page 64 →**



PictoChat **Page 65 →**



Nintendo DSi Browser **Page 68 →**

Others



Open Box Icon

This icon appears when no application is present. The number of empty boxes represents the number of applications that can be added.



Nintendo DSi + Internet Icon

Select this icon from the **Nintendo DSi Menu** to watch a video showing the many advantages of connecting your Nintendo DSi XL system to the internet. This video can be deleted after viewing to free up space.



Present Icon

This icon appears when you add a new application by purchasing it via Nintendo DSi Shop, or through some other means. Touch a present icon to unwrap the application icon.

Moving Icons



1 Hold the stylus on the icon you want to move, and slide the stylus up or down to pull the icon out of sequence. You can also press left and right on the **+**Control Pad to select the icon, then press up to move it up.

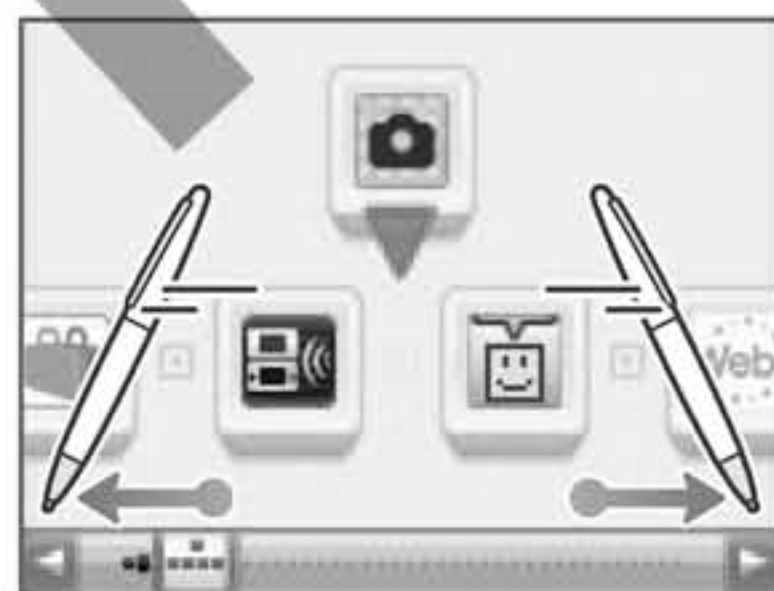

2 Scroll through the list until you find where you want to place it.

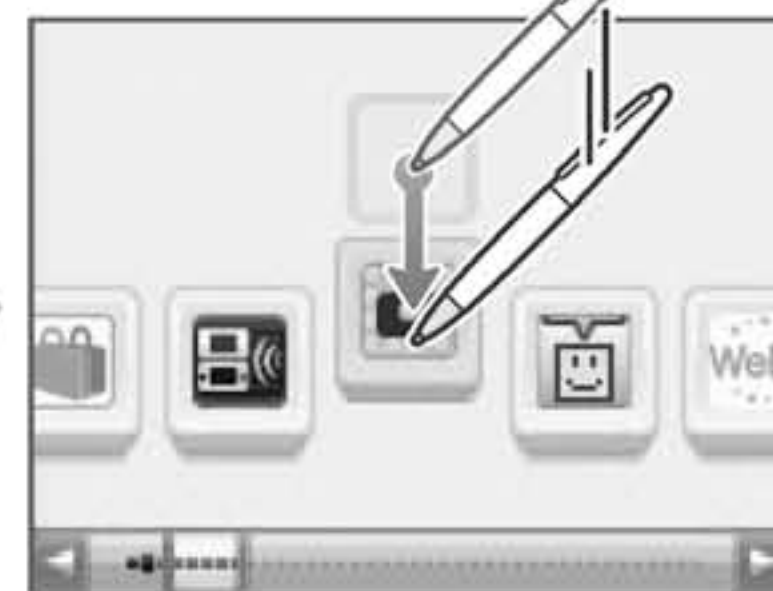

3 Place the icon into its new location and lift the stylus off the screen, or press down on the **+**Control Pad.



4 That's it! You're done.

Camera Mode

On the **Nintendo DSi Menu**, press the L Button or R Button to enter **Camera Mode**.

Note: Photos you take will be saved to the Nintendo DSi System Memory.



Number of photos remaining

Start Nintendo DSi Camera [Page 32 →](#)

Take a photo (L Button, R Button, or A Button)

Switch between inner and outer cameras (X Button)

Return to the **Nintendo DSi Menu** (B Button)

Turn the menu display on and off (Y Button)

Note: You can also use the buttons shown in brackets.

Top Screen Photo Display

- Photos taken in **Camera Mode** will appear on the top screen of the **Nintendo DSi Menu**.

- If you have taken multiple photos in **Camera Mode**, the photo that appears on the top screen will change every time you turn the Nintendo DSi XL system on or exit **Sleep Mode** by opening the Nintendo DSi XL system.

- You can use the Nintendo DSi Camera photo album to select which photos appear on the top screen.

[Page 44 →](#)

Album Screen in
Nintendo DSi Camera

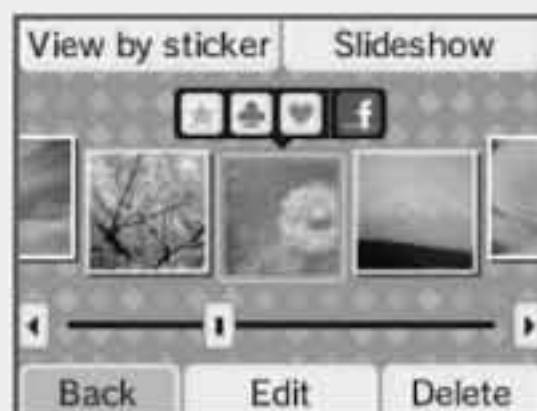

Using Game Cards

Starting a Game

- 1 Insert a Game Card in the Game Card slot. If you have trouble inserting the Game Card, remove it and check that the label is facing outwards.

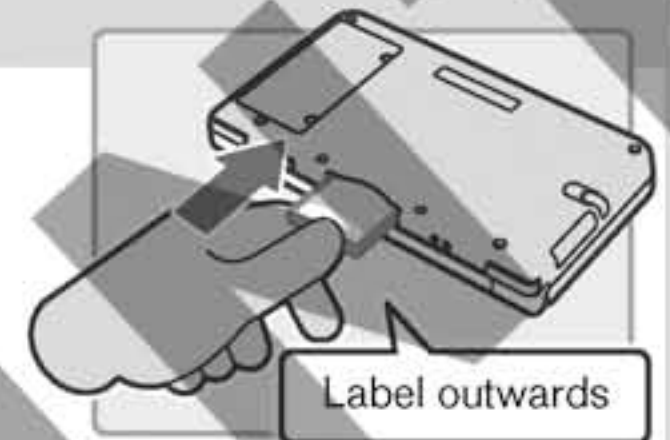

- 2 Press the POWER Button.

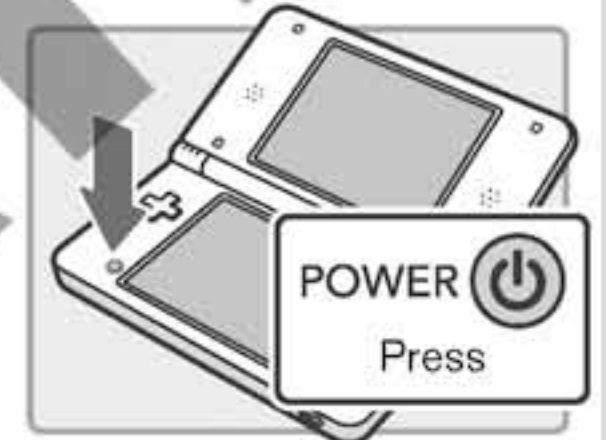

- 3 Touch the Game Card icon.



- 4 Refer to the game's Instruction Booklet for game play information.

Exiting a Game

- 1 Press and hold the POWER Button.

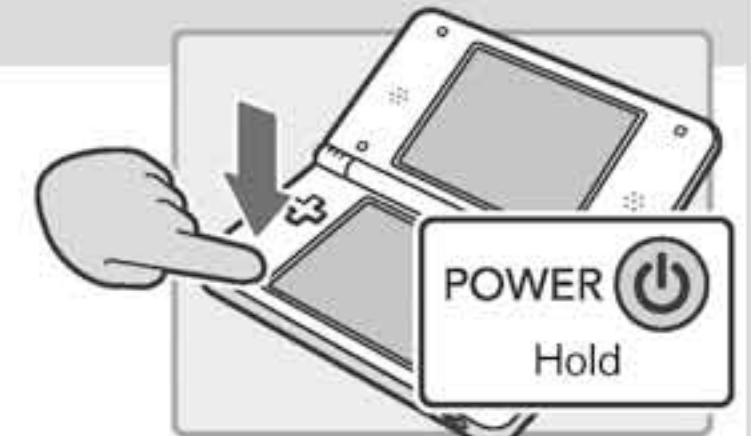

- 2 Press in until you hear a clicking sound and then pull out the Game Card. Be careful that you don't press and release the Game Card too hard, or it might pop out quickly.

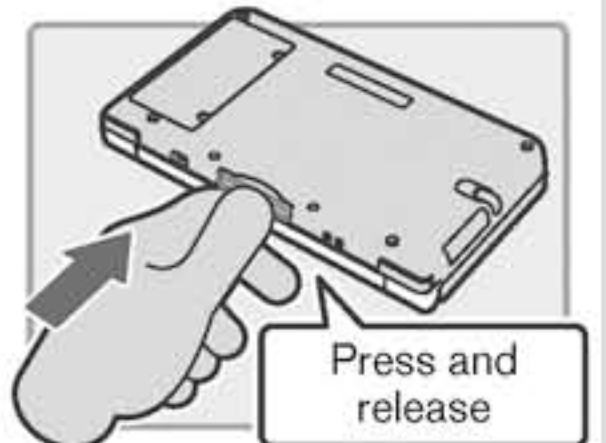

Incompatible Nintendo DS Software and Peripherals

The following software and peripherals cannot be used with Nintendo DSi XL.

- Nintendo DS Browser Card
- Nintendo DS Memory Expansion Pak (NTR-011)
- Nintendo DS Lite Memory Expansion Pak (USG-007)

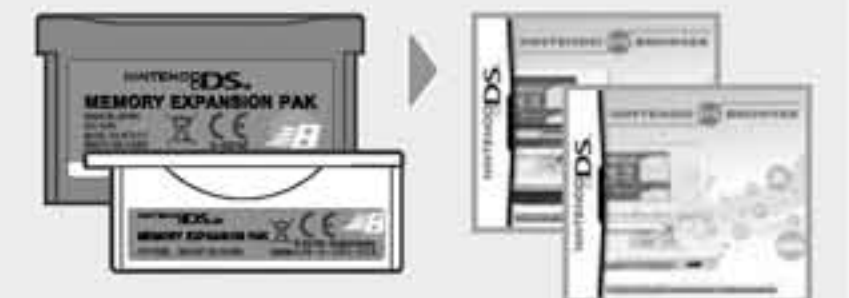

- Nintendo DS Rumble Pak (NTR-008)



In addition to these products, it is not possible to use any peripherals that would connect to the Nintendo DS or Nintendo DS Lite systems via the Game Boy Advance™ Game Pak slot or anything that functions in conjunction with a Game Boy Advance Game Pak.

📷 Nintendo DSi Camera

With Nintendo DSi Camera, you can use 11 different types of lens to take photos, watch slideshows of your photos and exchange photos with other Nintendo DSi / Nintendo DSi XL systems.



What is Nintendo DSi Camera?

Have fun taking photos

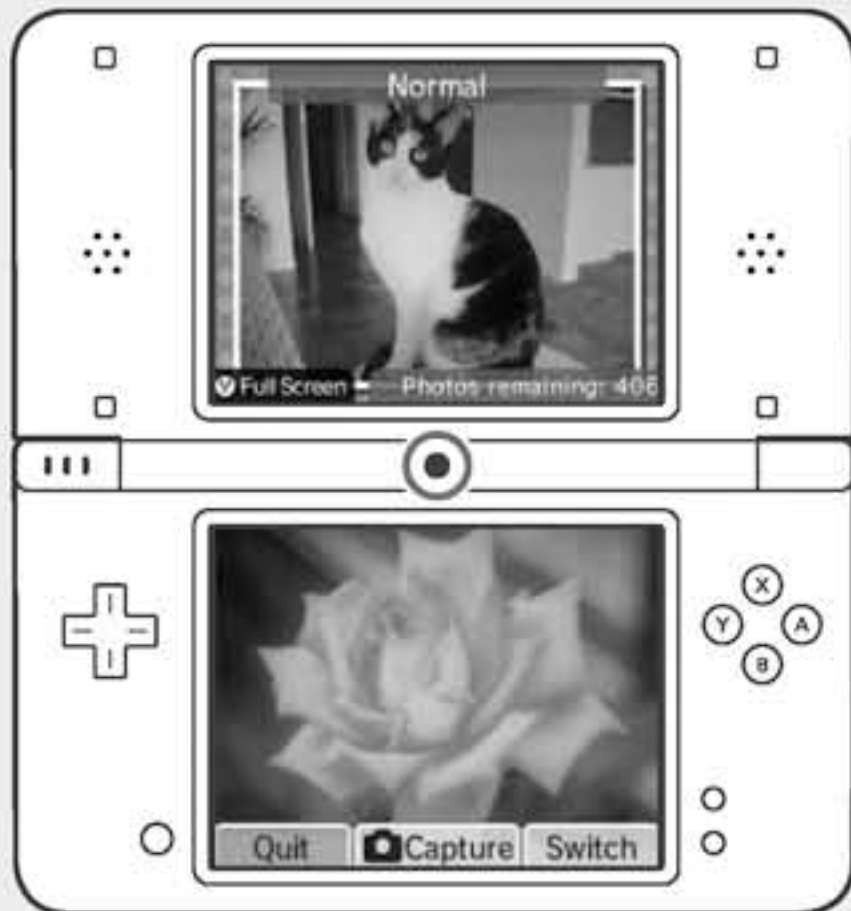

There are two cameras on the Nintendo DSi XL system: one inner and one outer.



Have fun decorating, distorting and changing the colours, or just take normal photos.

View



Photos can be added to the Album, made to appear as a Slideshow and viewed according to the date they were taken. Additionally, photo data can be saved to an SD Card and shared between Nintendo DSi and Nintendo DSi XL systems.

Getting Started

When you start Nintendo DSi Camera, you will have several options available. Touch the Touch Screen to make a selection.

Screen Layout Explanation

Switch to the Nintendo DSi System Memory

Switch to SD Card*

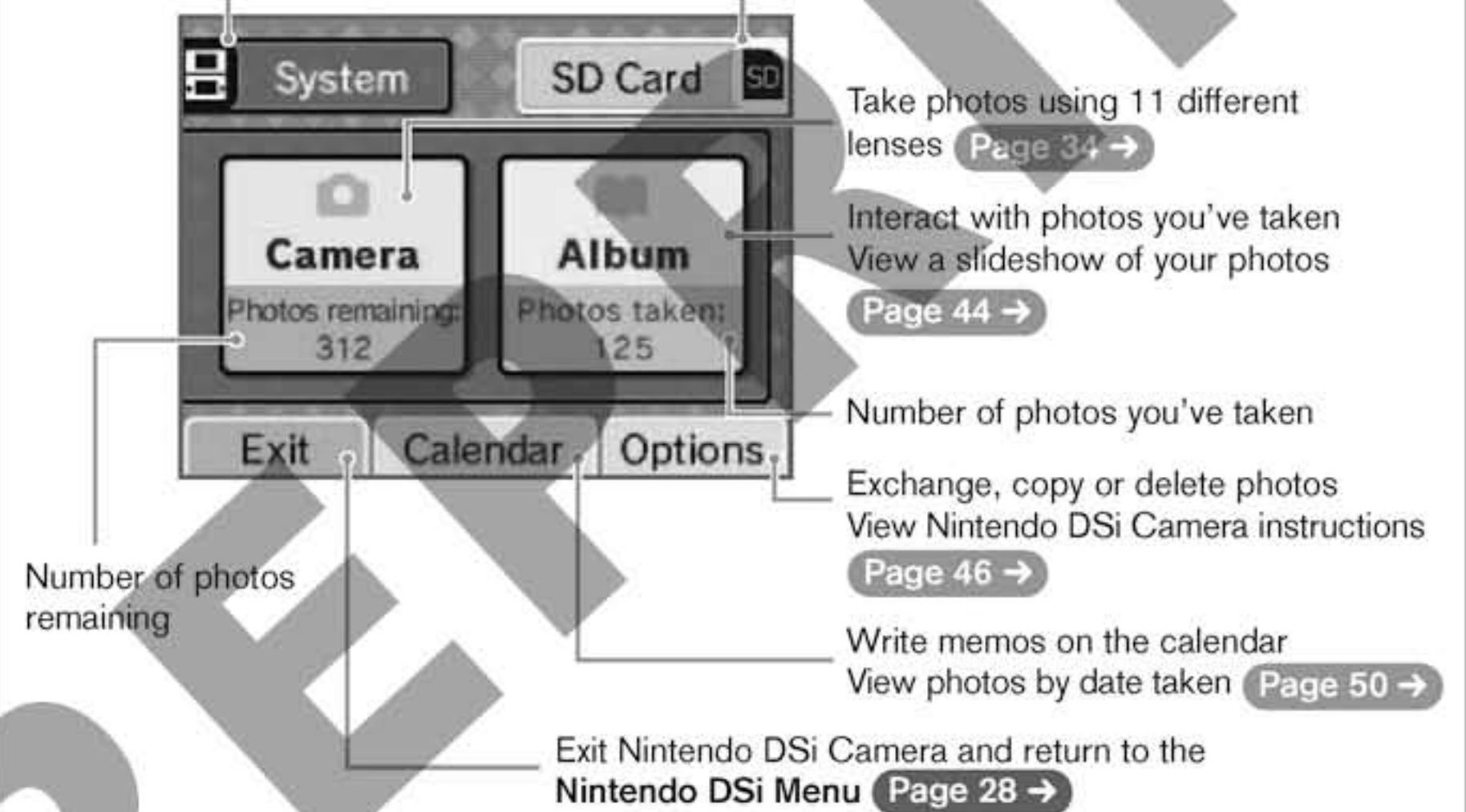

*By saving to an SD Card, you can view your photos on a computer or print them out. (This requires a computer that can read SD Cards.)

How Many Photos Can I Save?

- Check the PHOTOS REMAINING display to see how many photos you can save in your selected location. Because the size of photo data can vary, this number is only a rough indicator – it does not reflect a precise number of photos.
- Since photo data size varies, taking one photo may also decrease remaining photos by two or even none at all.

• SD Cards can save up to a maximum of 3,000 photos, regardless of how much free space they have available.

Selecting a Lens

Touch CAMERA in the **Nintendo DSi Camera Menu** to view the **Lens Selection Screen**. Touch the icon representing the lens you want to use, and then touch START to begin using that lens.

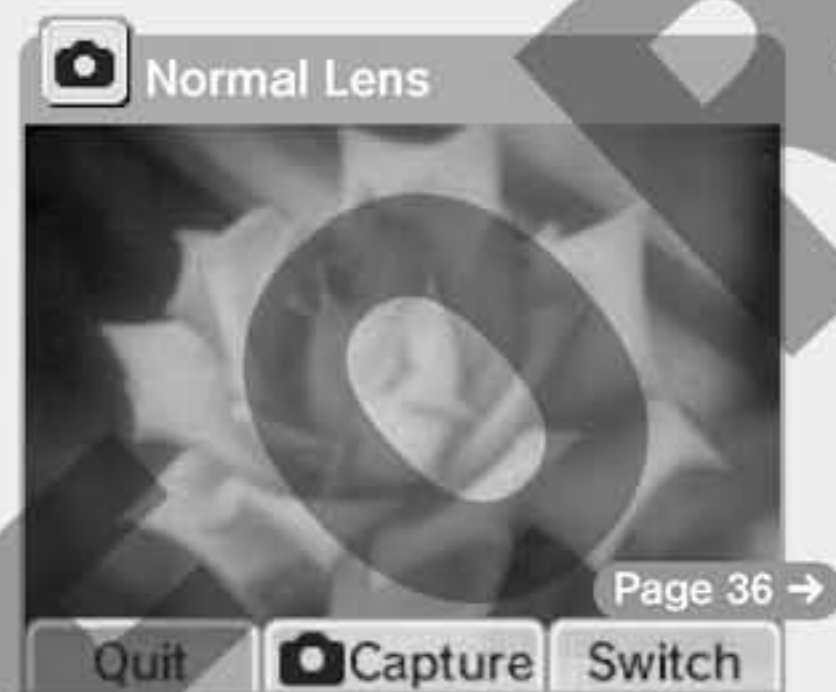
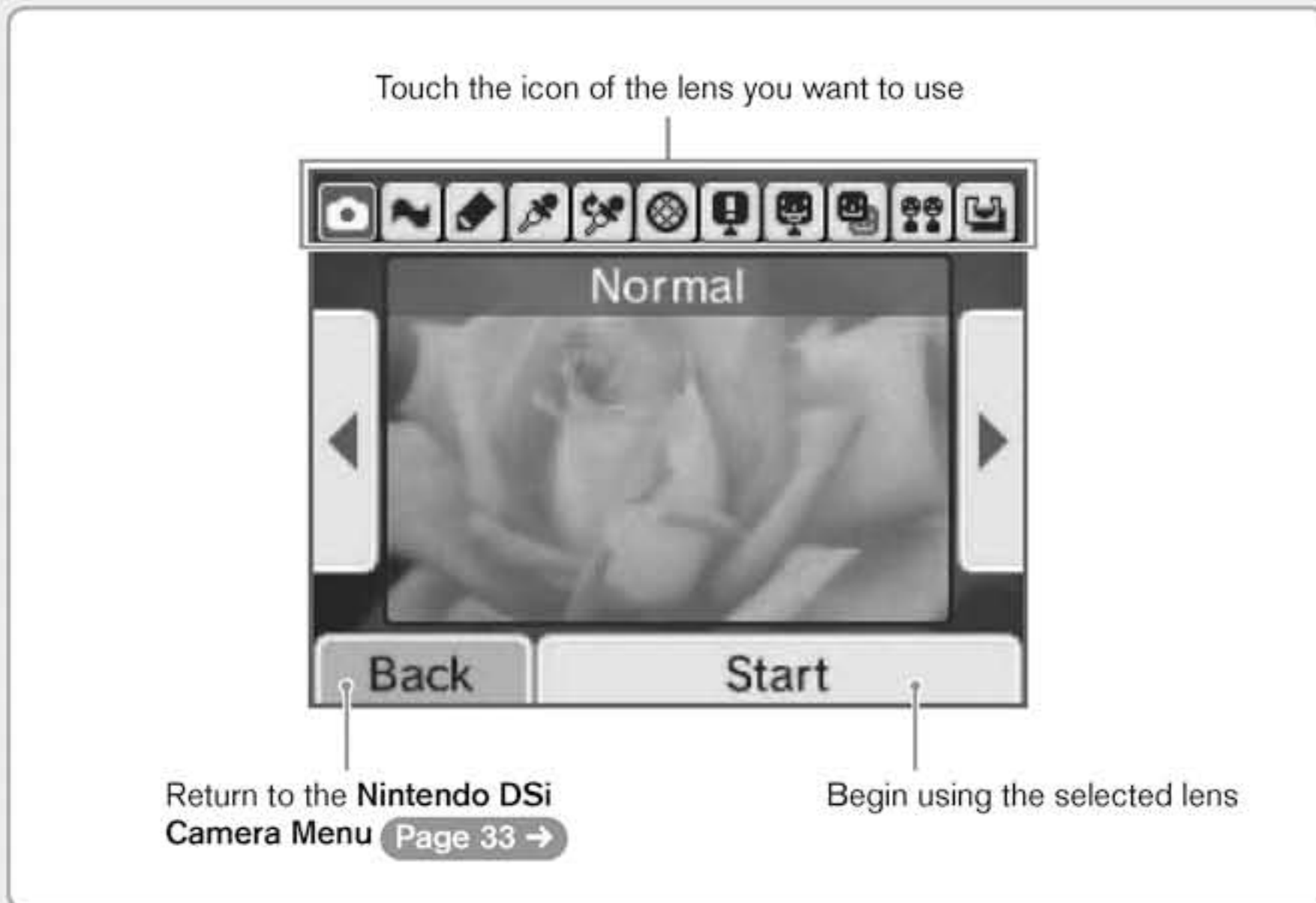

Take normal unaltered photos.



Slide the stylus across the Touch Screen to distort the image.



Doodle on your photos.

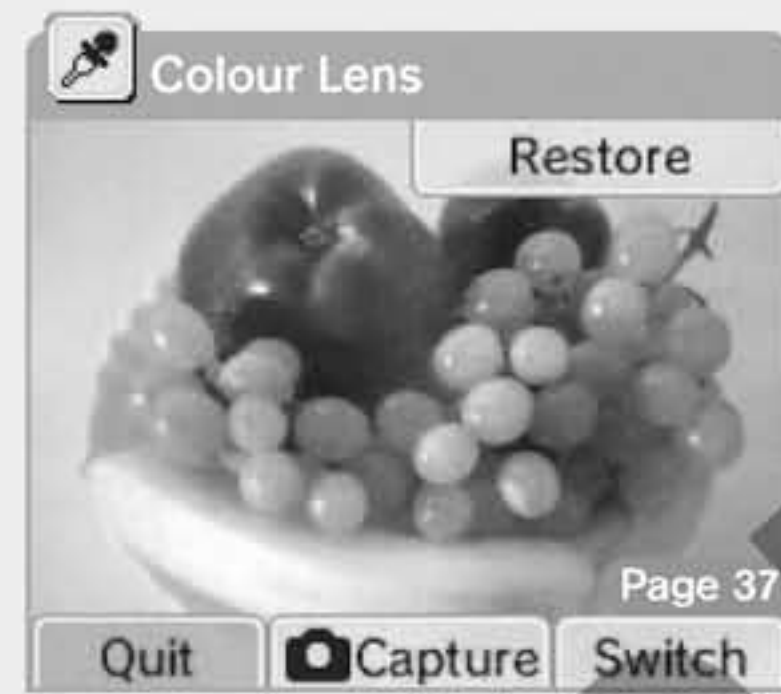

Restore colour to black-and-white photos.

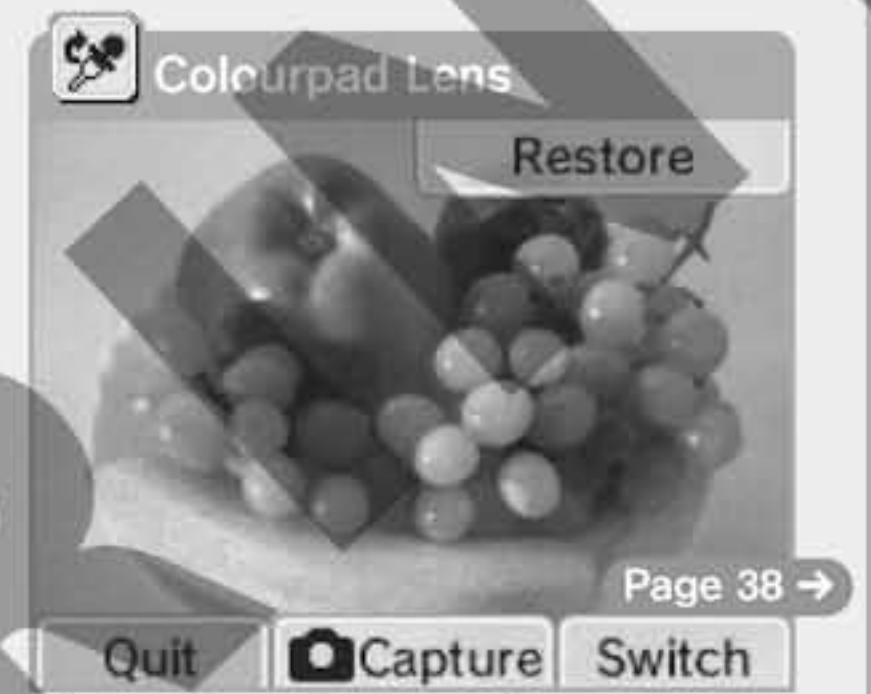

Alter colours in your photos.



Apply a variety of mirror effects.



Add mischievous effects to faces.

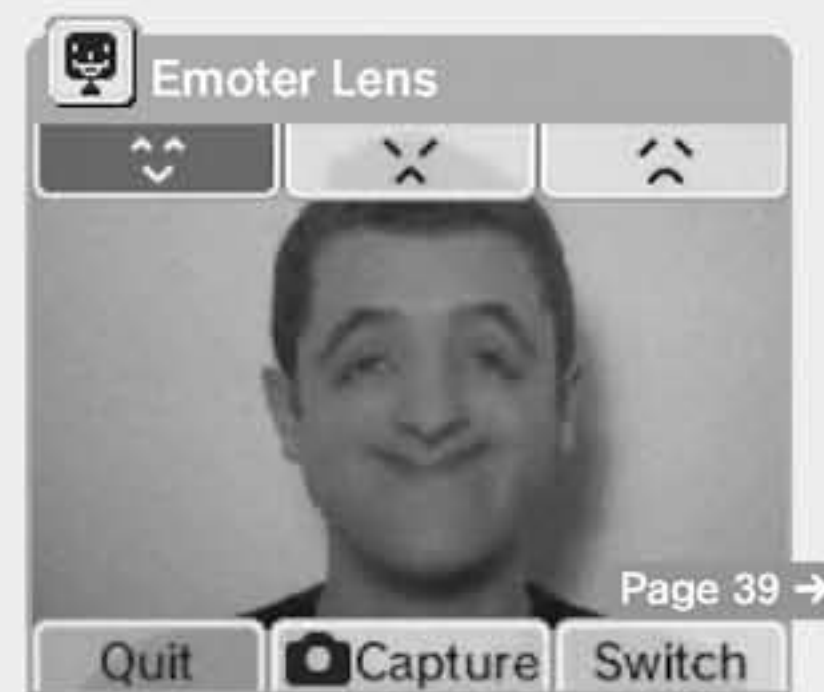

Change facial expressions.

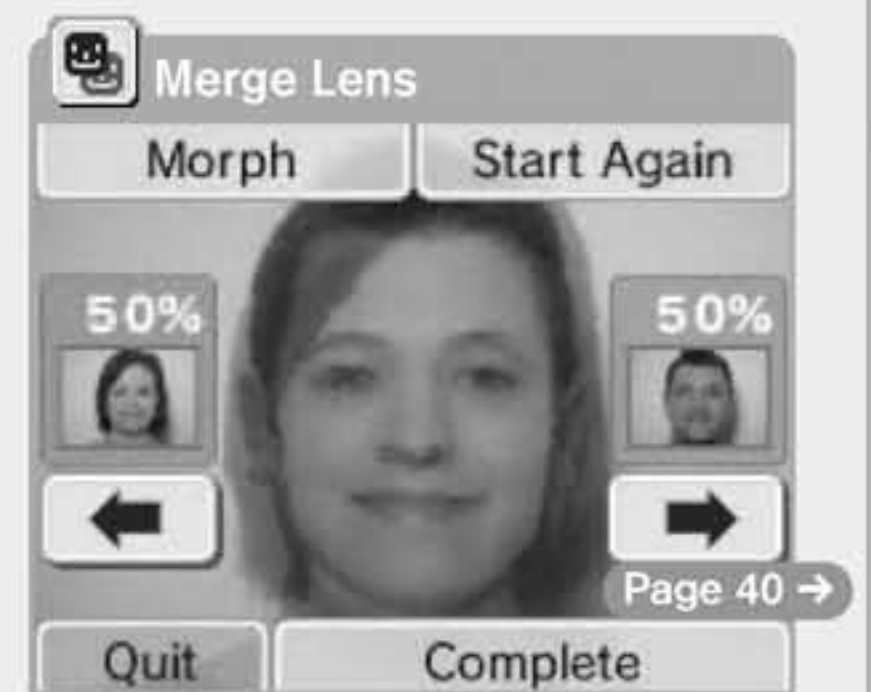

Blend photos of two faces together.

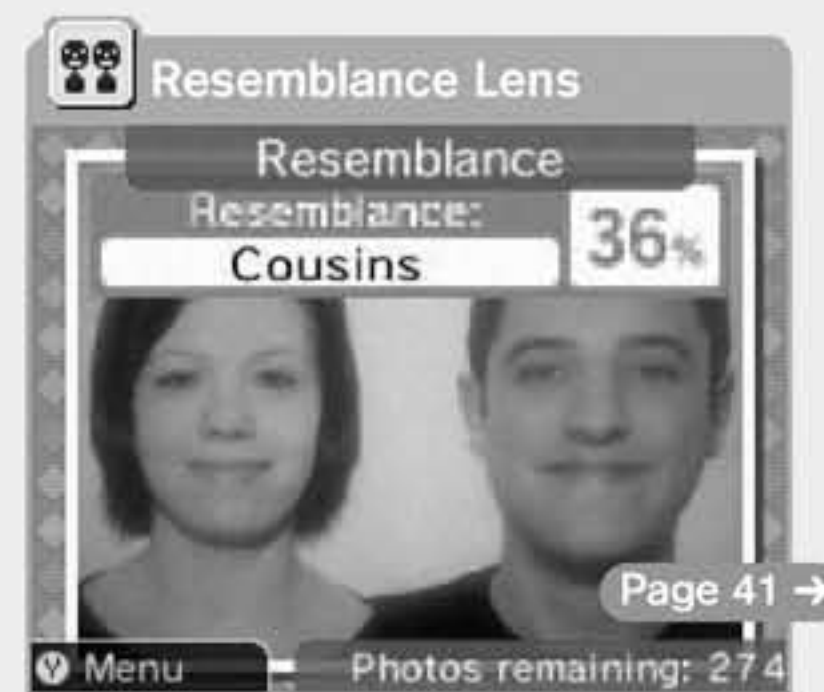

Evaluate how similar two faces are.

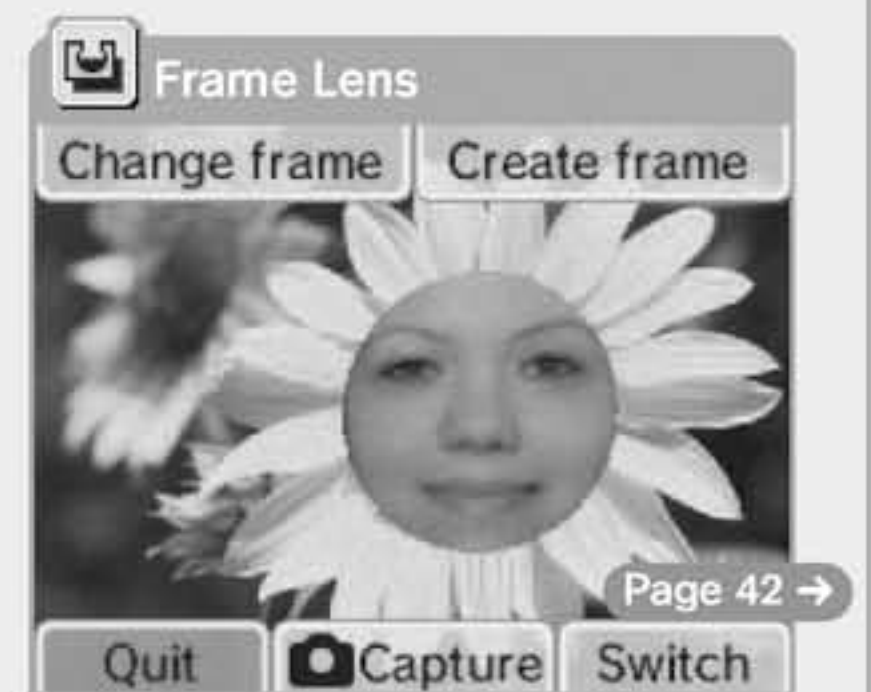

Create frames and take photos within those frames.

Using the Cameras

Normal Lens

This lens works like a normal camera and has no special effects.

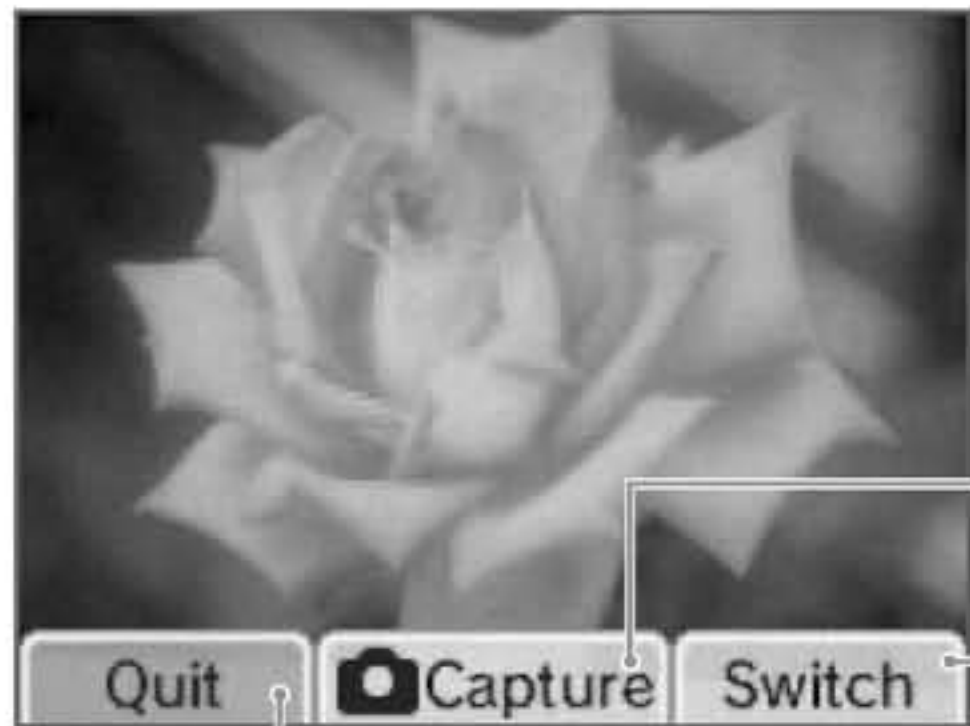

Take a photo
(L Button, R Button or A Button)

Switch between the inner and outer
camera (X Button)

Return to **Lens Selection Screen** (B Button) [Page 34](#) →

The menu display for icons like can be toggled
on and off (Y Button)

Note: These controls are the same for all lenses. You can also use the buttons shown
in brackets.

Distortion Lens

Use this lens to distort the image by sliding the stylus across the Touch Screen.

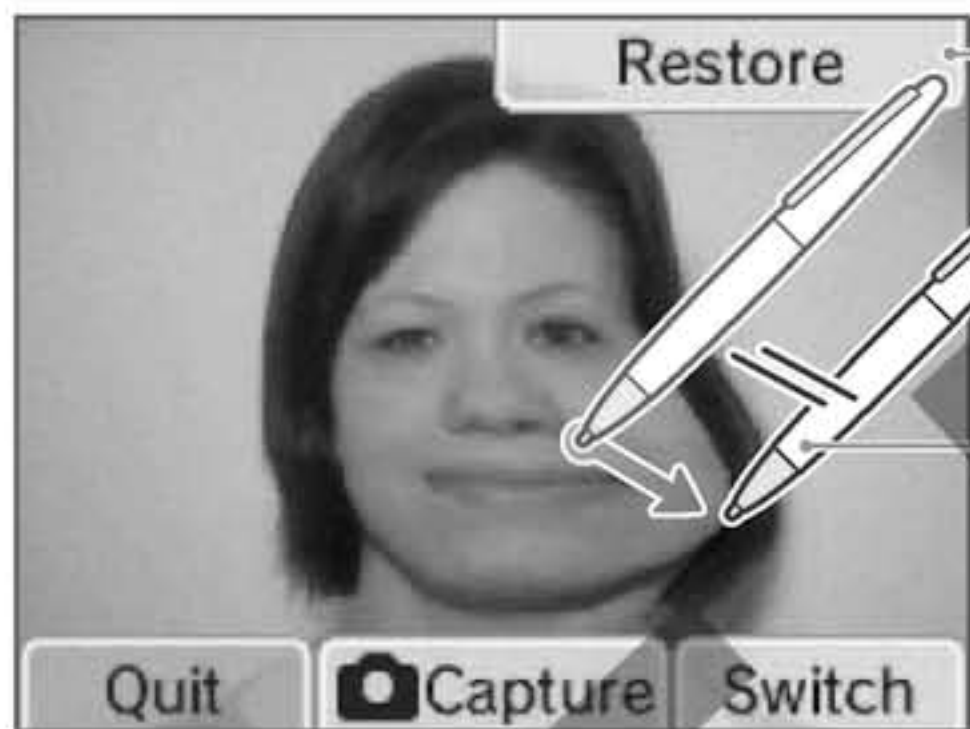

Restore the distorted image to normal

The photo gets stretched in the
direction you move the stylus



Graffiti Lens

Use this lens to decorate your photos using pens and stamps.

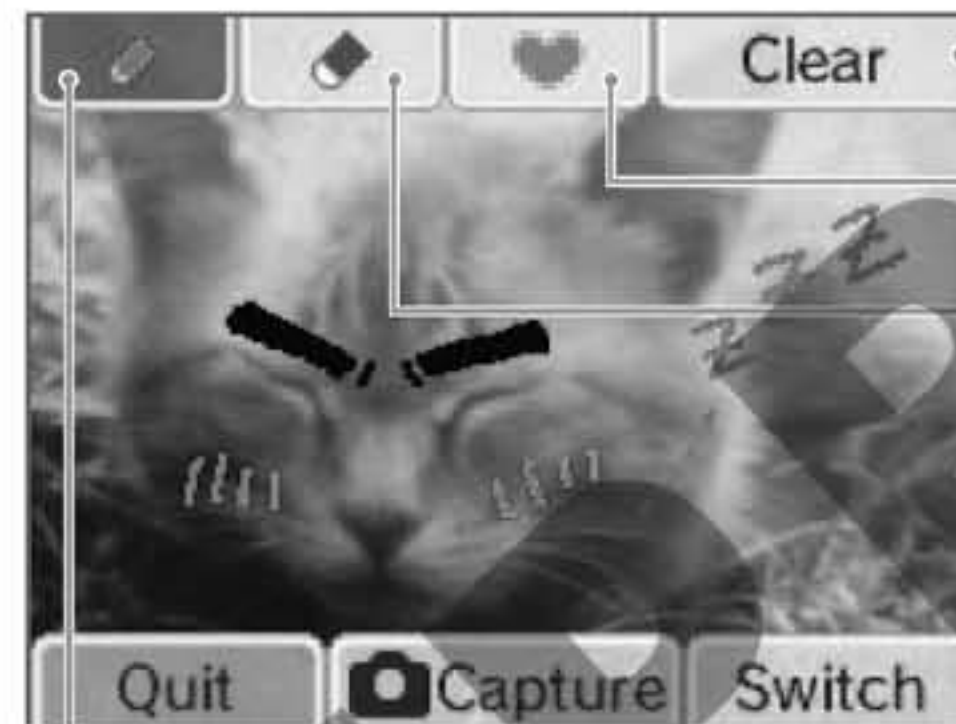

Erase all graffiti

Use a stamp

Use an eraser

There are three eraser sizes.

Use pens or droppers (you can select pen colour and thickness)
You can set your pen colour to any colour you see on screen by using the dropper.

Using Droppers



1 Select a dropper

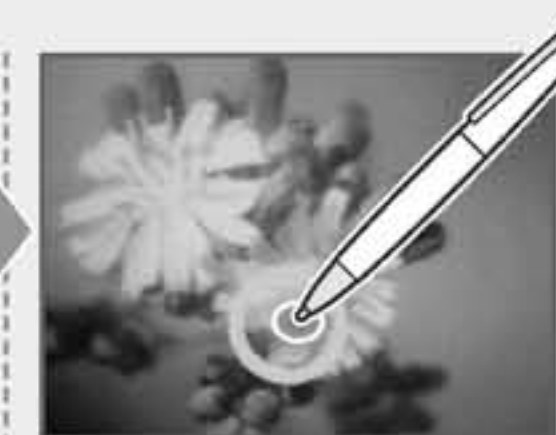

2 Touch any colour



3 The pen changes to
the colour you touched

Colour Lens

This lens converts the image to black-and-white. Any colour can be added back
into the image by simply touching the screen.

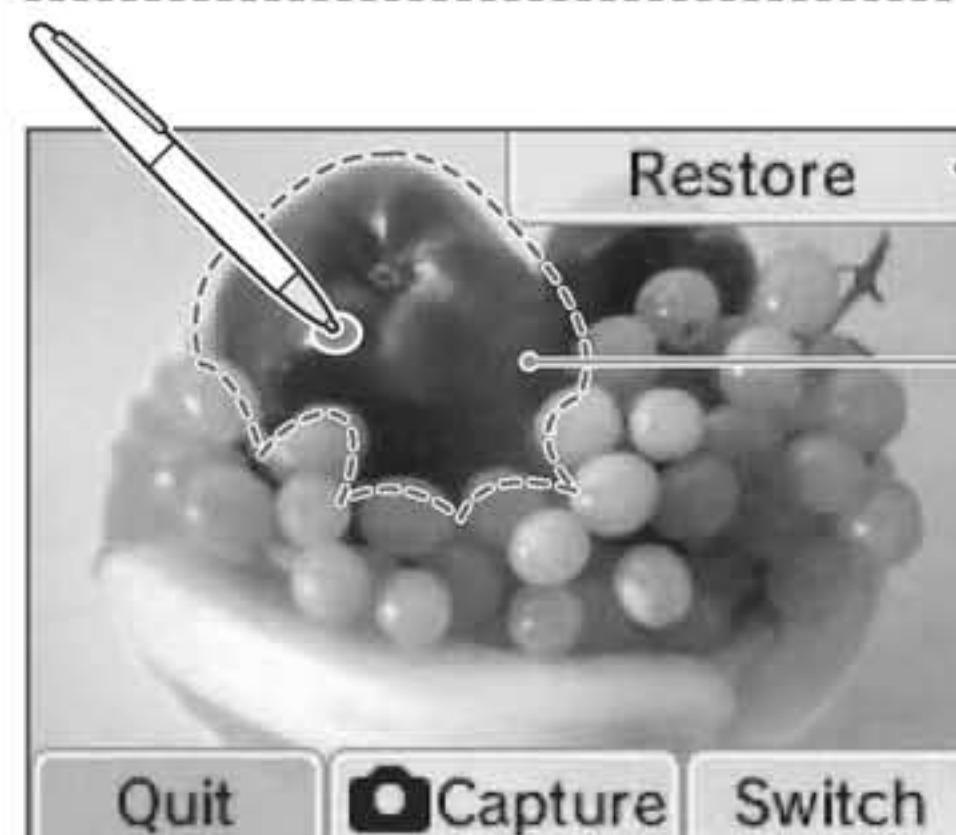

Restore the entire screen to
black-and-white

This colour has been added back into
the image

Using the Cameras



Colourpad Lens

Use this lens to change the colours in your photos. Each time you touch a colour it will change.

Note: Touching white, black or grey areas will not change their colour.

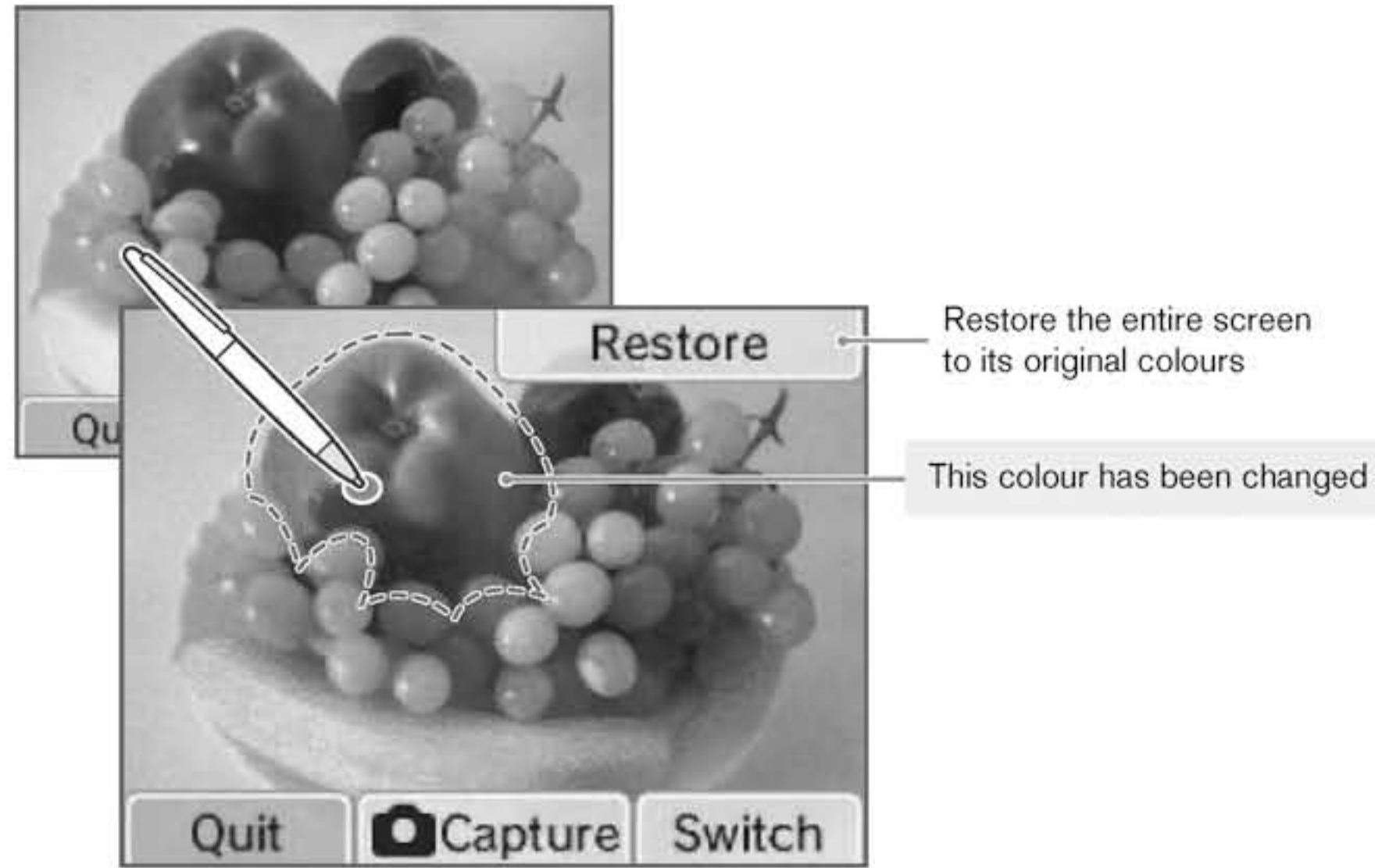

Mischief Lens

Use this lens to add special effects to the faces in your image.

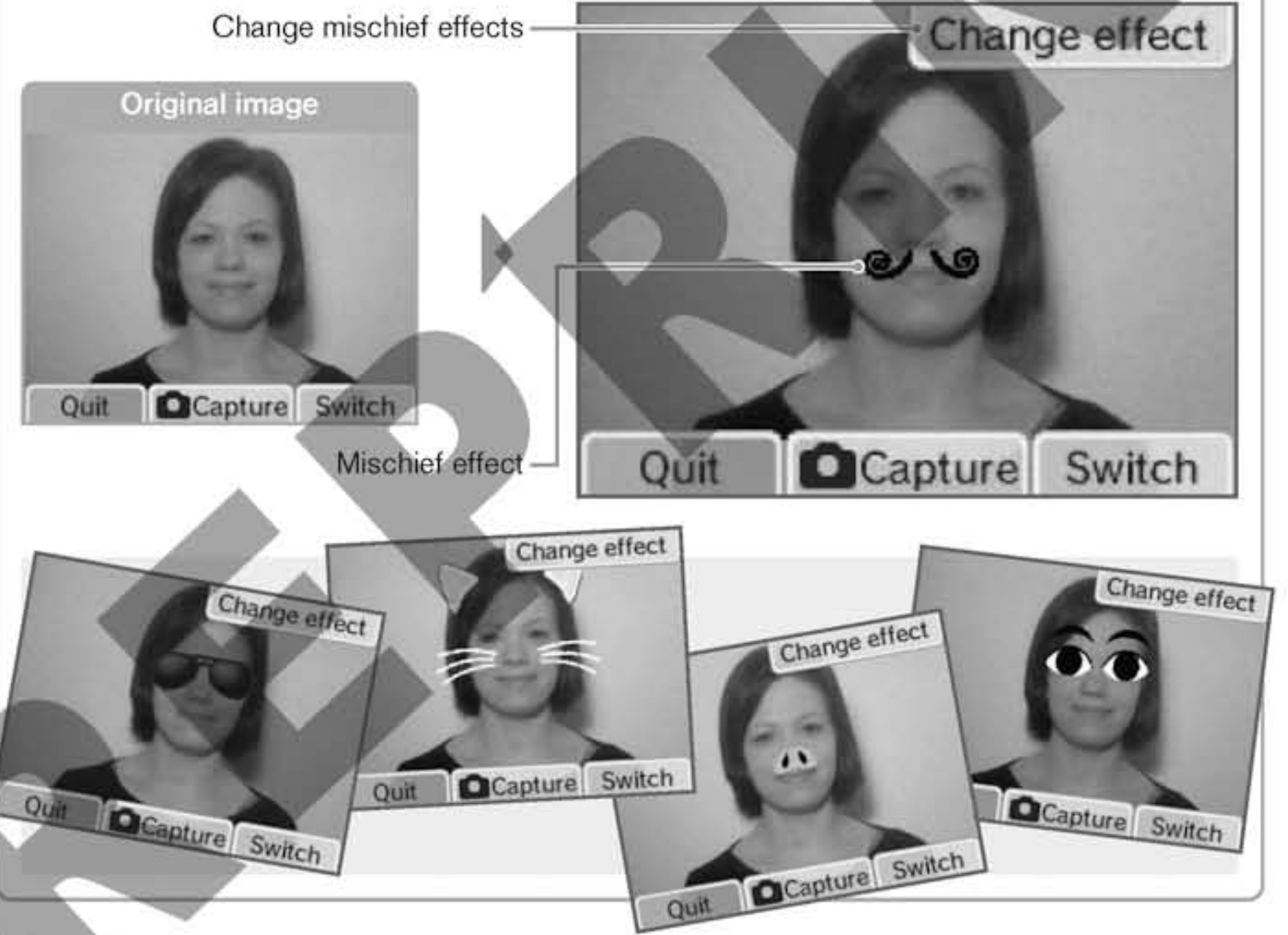

Mirror Lens

Use this lens to add mirror effects to your photos.

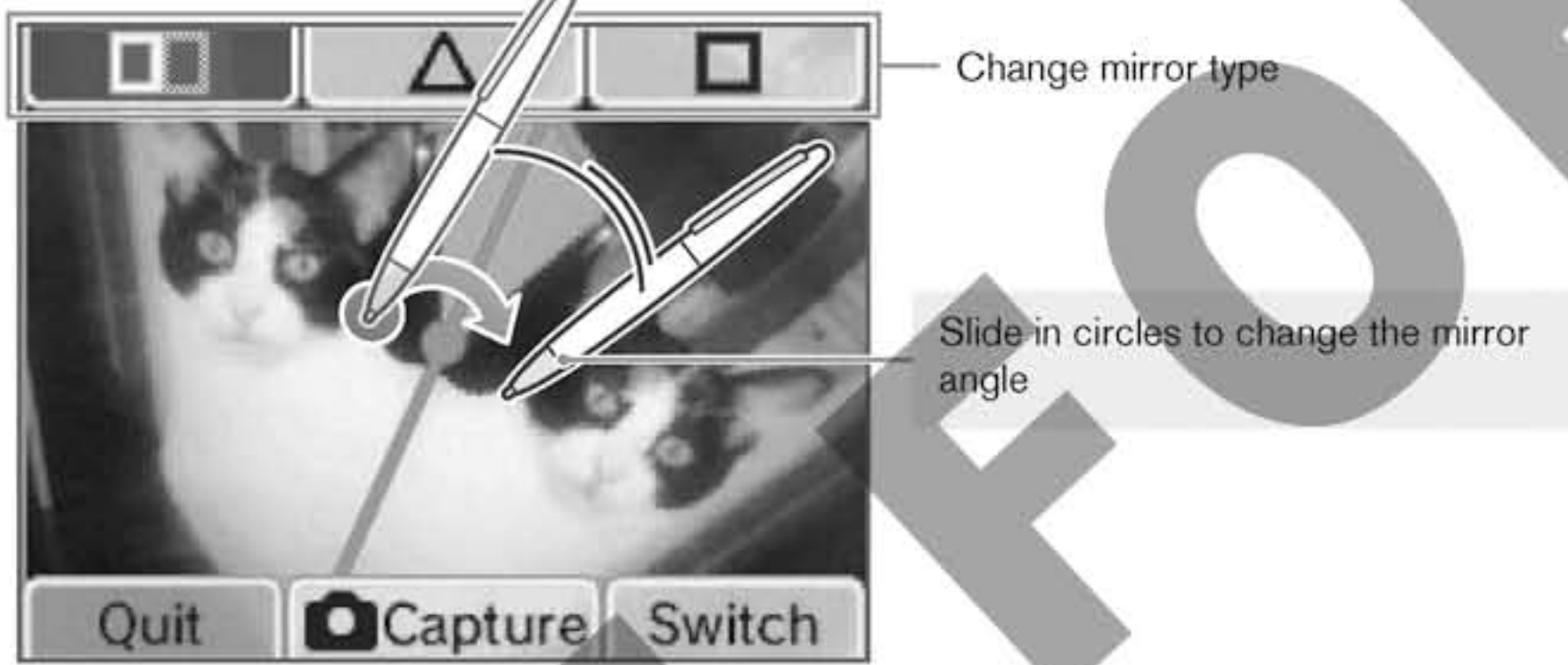

Split mirror

Triangular mirror

Square mirror

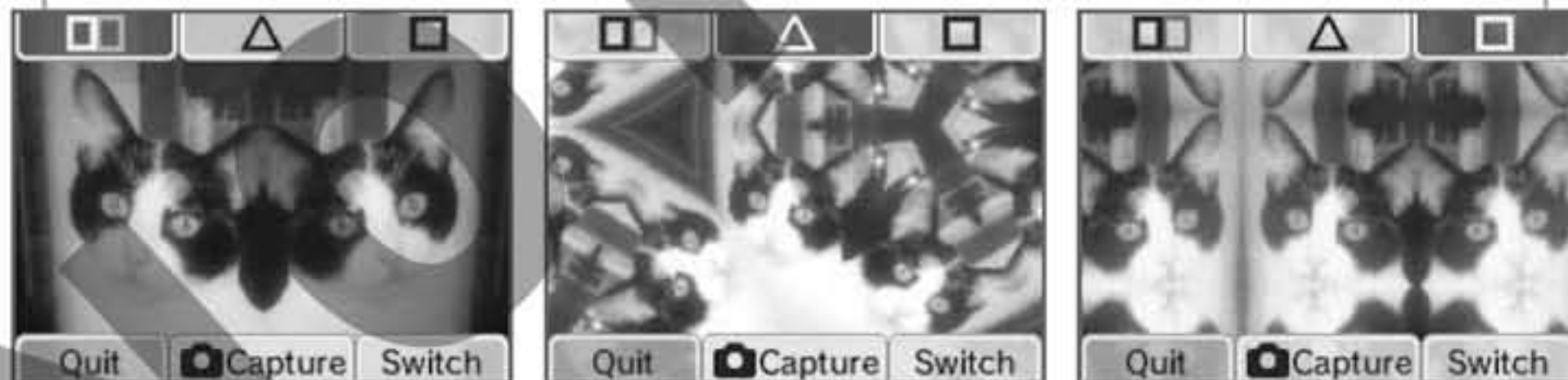

Emoter Lens

Use this lens to change the expressions on the faces in your image.

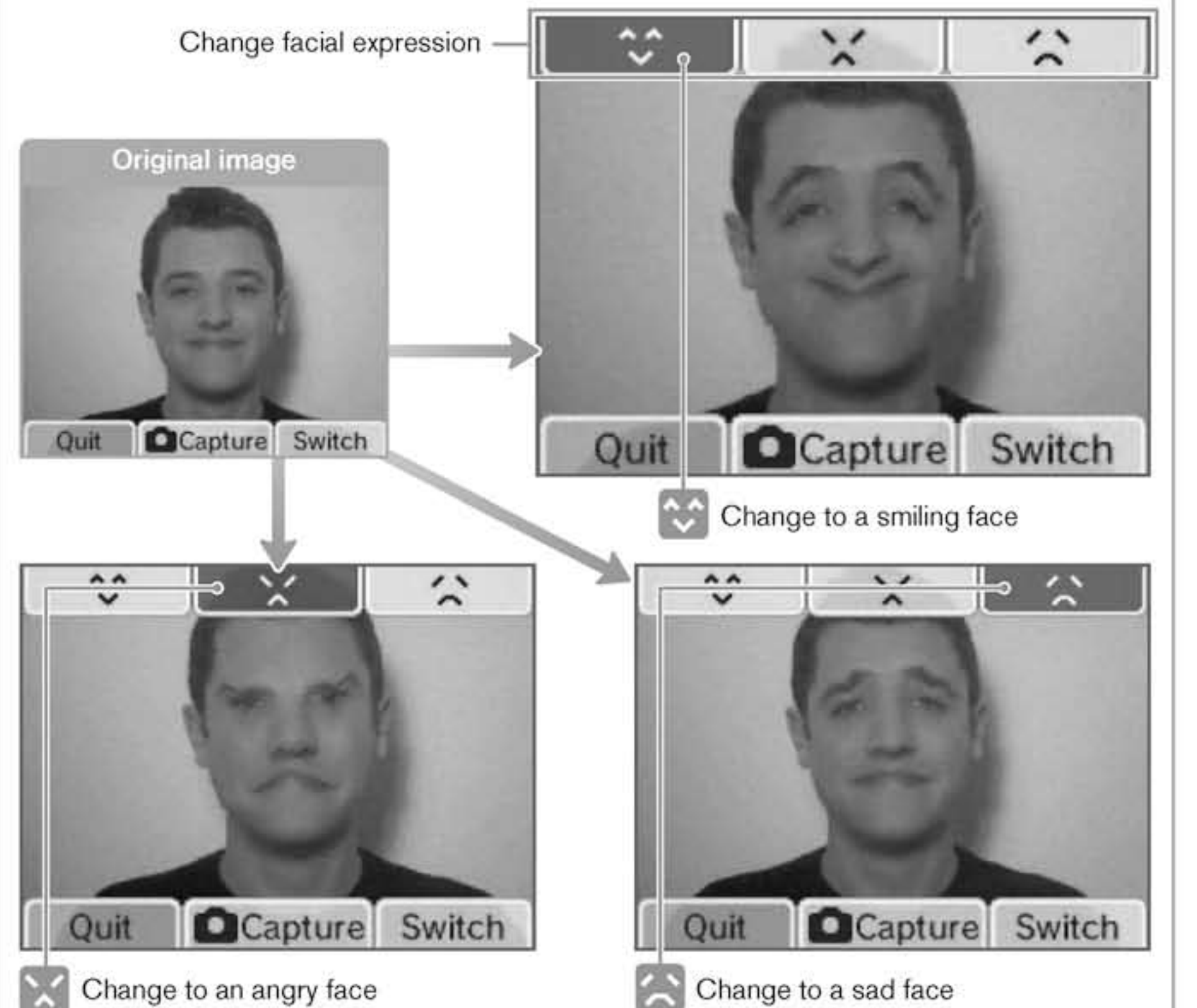

Merge Lens

Use this lens to blend the photos of two faces together.

- 1 Capture a photo of the first face.
Try to get the face as large as possible and centred on the Touch Screen.



- 2 Capture the second face as you did the first.
It's easier to merge the faces if the second face is as close as possible in size and position to the first face.



- 3 Once you have the results of the merge, touch or to change the merge ratio (%) of the two faces.

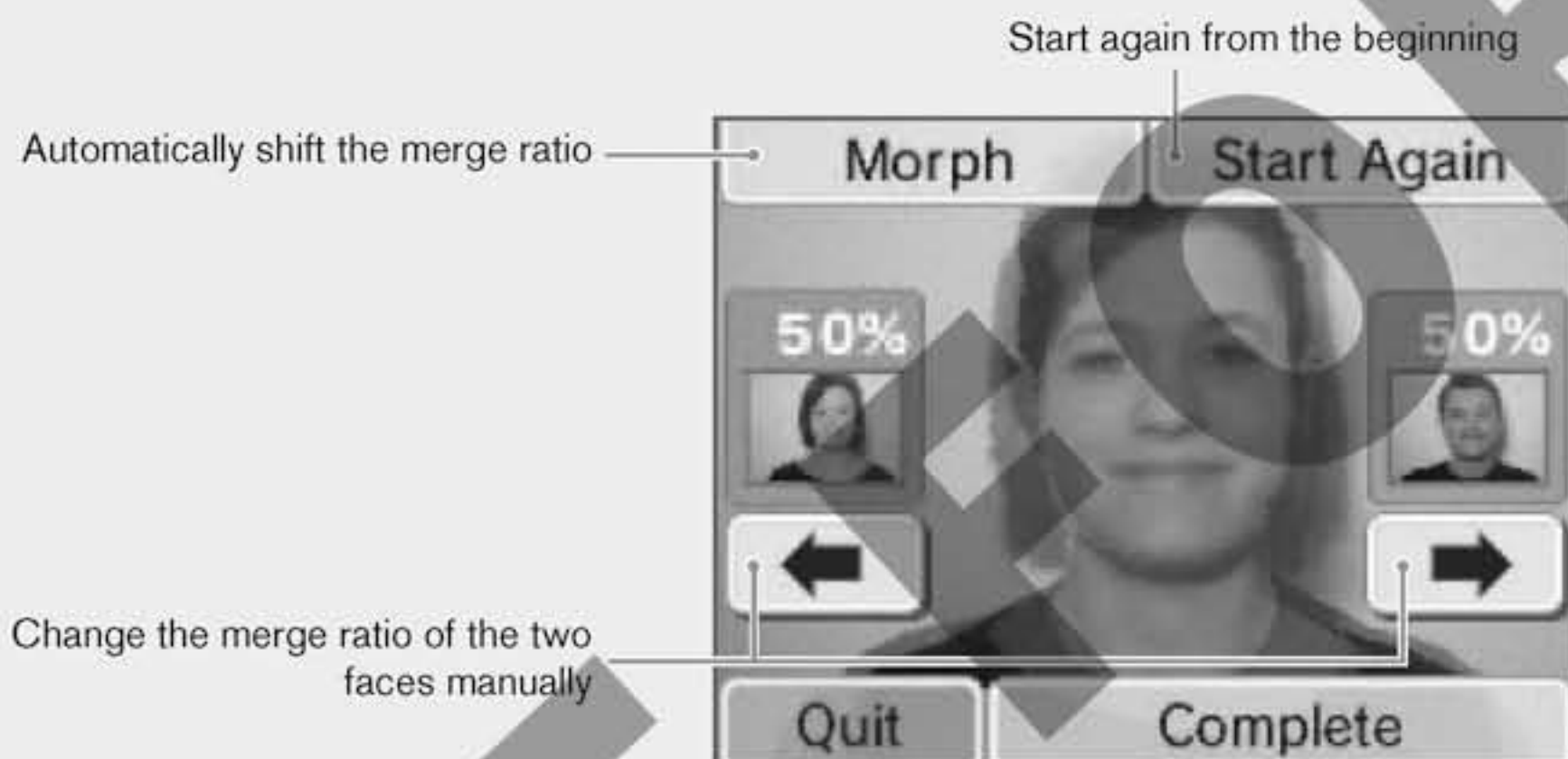

- 4 Touch to save the image.



Resemblance Lens

Use this lens to evaluate how similar two faces are.

- 1 Line up two faces on the screen.
A square frame will appear around a face once it has been recognised.



- 2 When both faces have been recognised, touch .



- 3 The resemblance results will appear, and the photo will be saved.

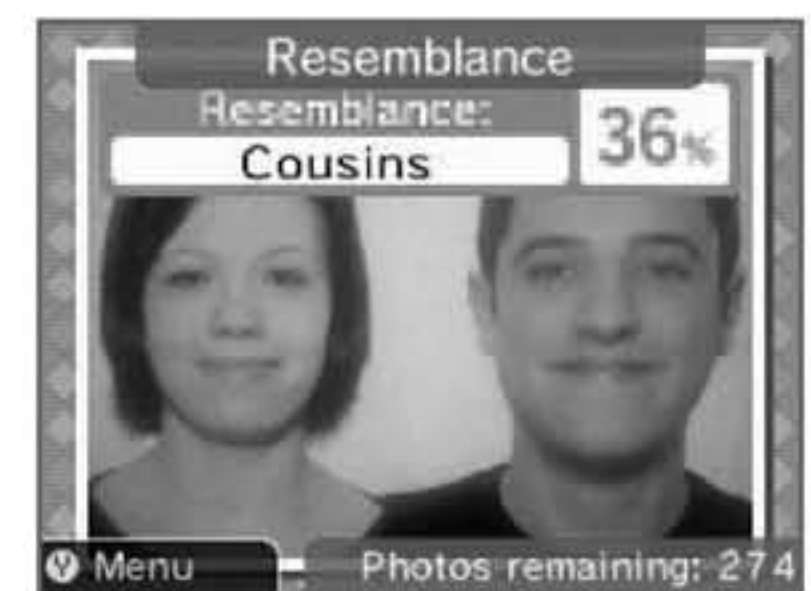

Warnings Regarding Face Recognition

For more precise facial recognition when using the Mischief, Emoter, Merge or Resemblance lenses, pay attention to the following points:



Take photos in a bright environment.



Capture the whole face on-screen.



Capture the face from the front.



Don't tilt the head.



Lift fringe to make eyebrows visible.



Take off glasses.

Please keep in mind that following these steps may not ensure perfect facial recognition.

Frame Lens

This lens can be used to take photos within frames (photos with part of the image removed). You can use one of the default frames included with Nintendo DSi Camera or you can create your own to use.

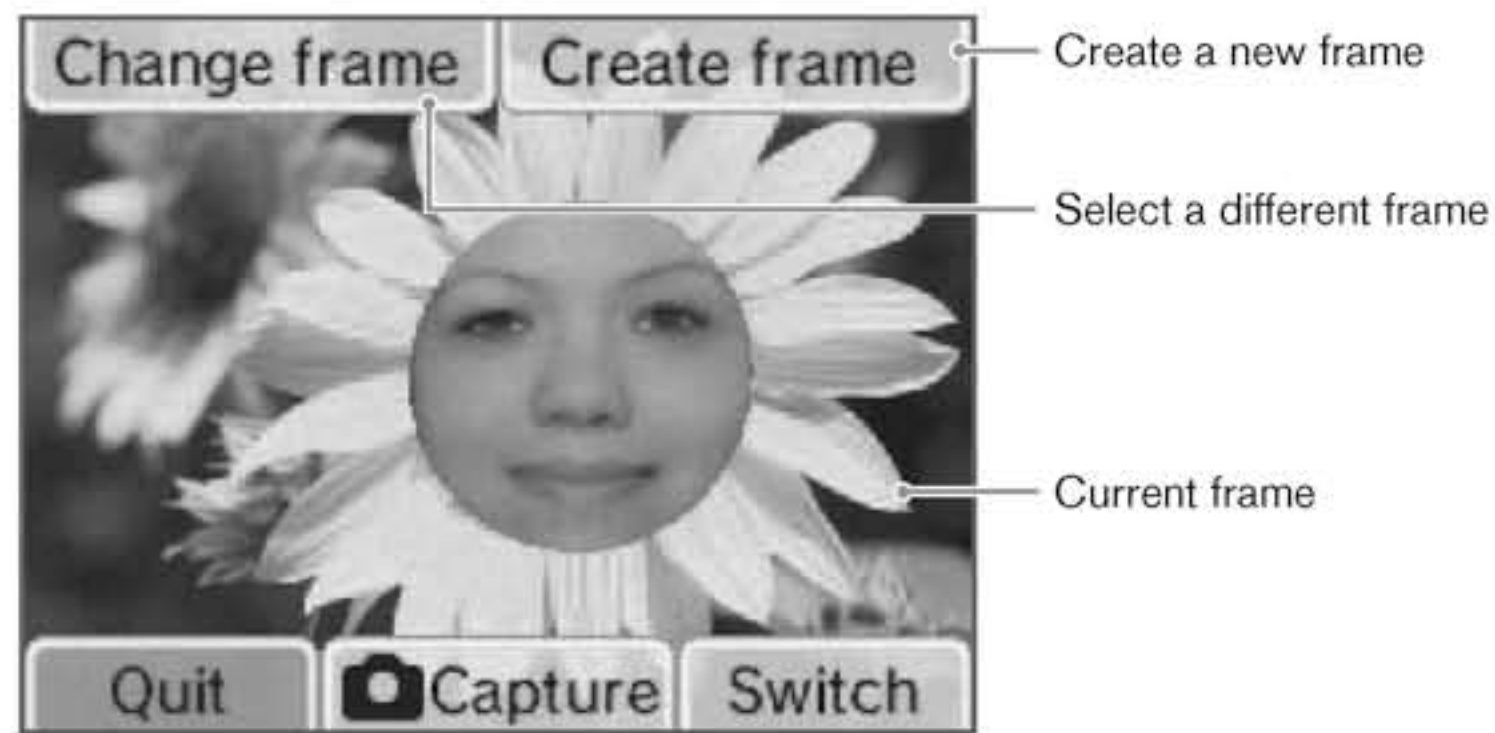

Creating Frames

1 Touch **CREATE FRAME** on the Touch Screen.



2 Select whether you want to take a new photo or use a photo you've already taken.

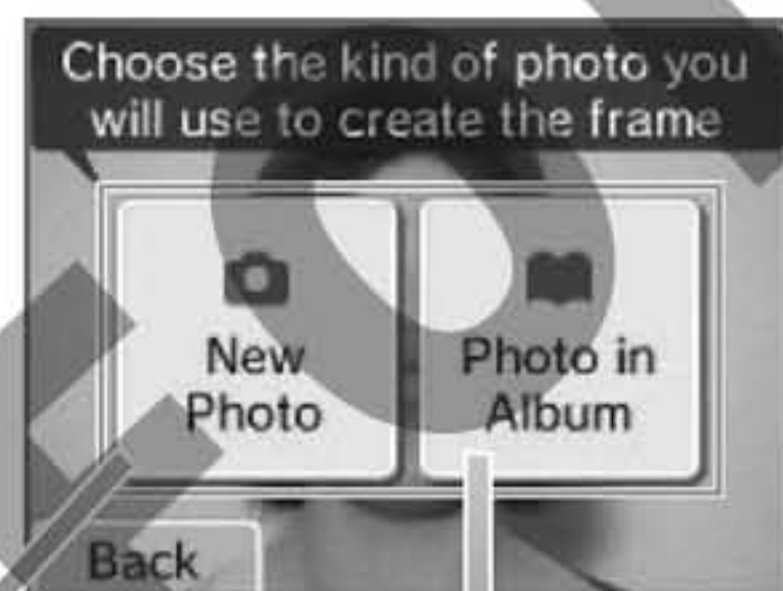

Take a new photo to use as a frame.



Select a photo from your album and touch **OK**.

4 Use the eraser to carve out a blank area in the photo.

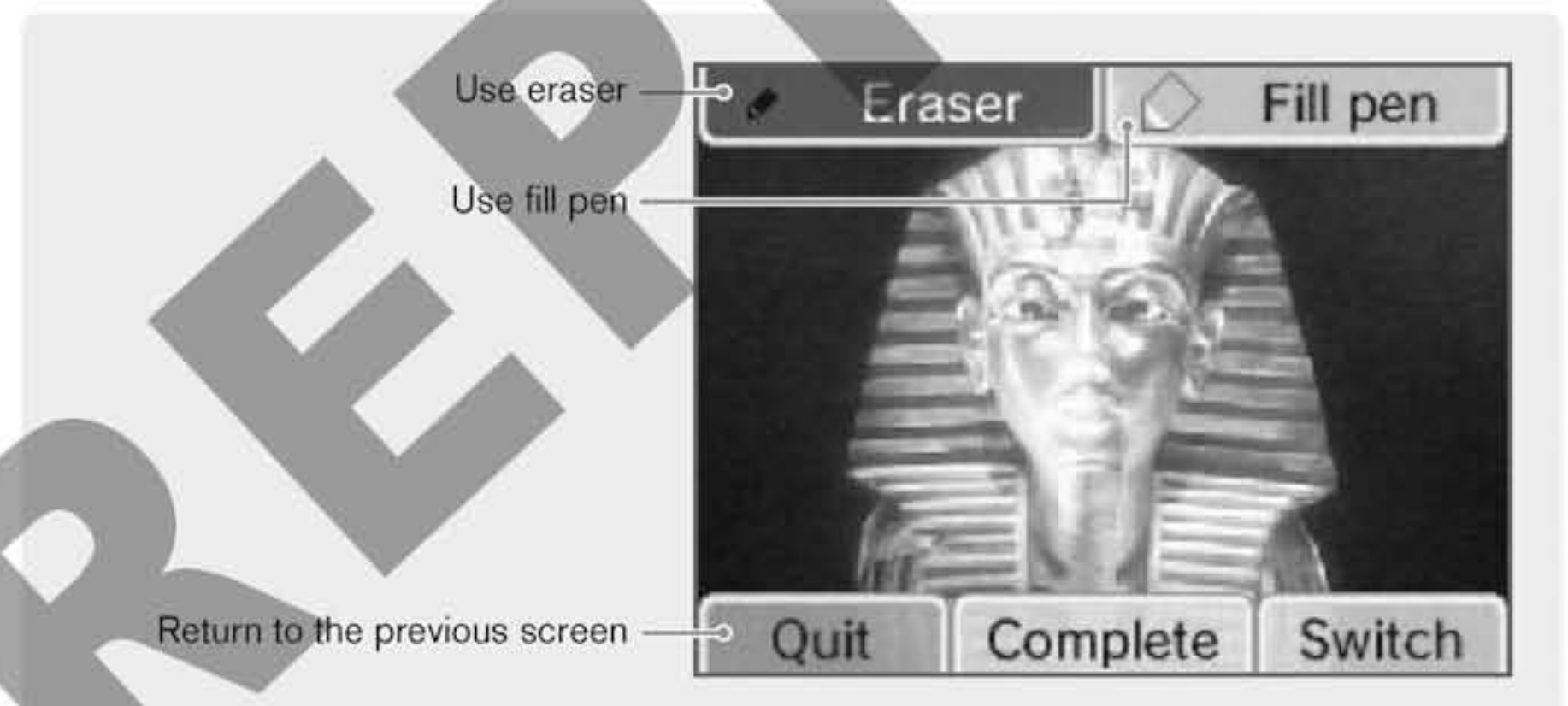
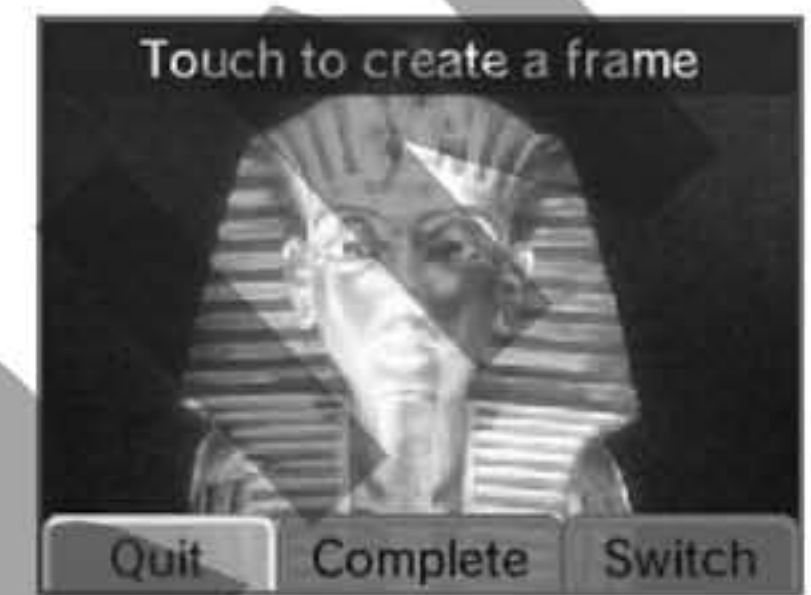

5 Touch **Complete** to save your frame. The completed frame is saved as frame data. You can select it by touching **CHANGE FRAME**.



Now, you can use the frame you just created and take a new photo with it!

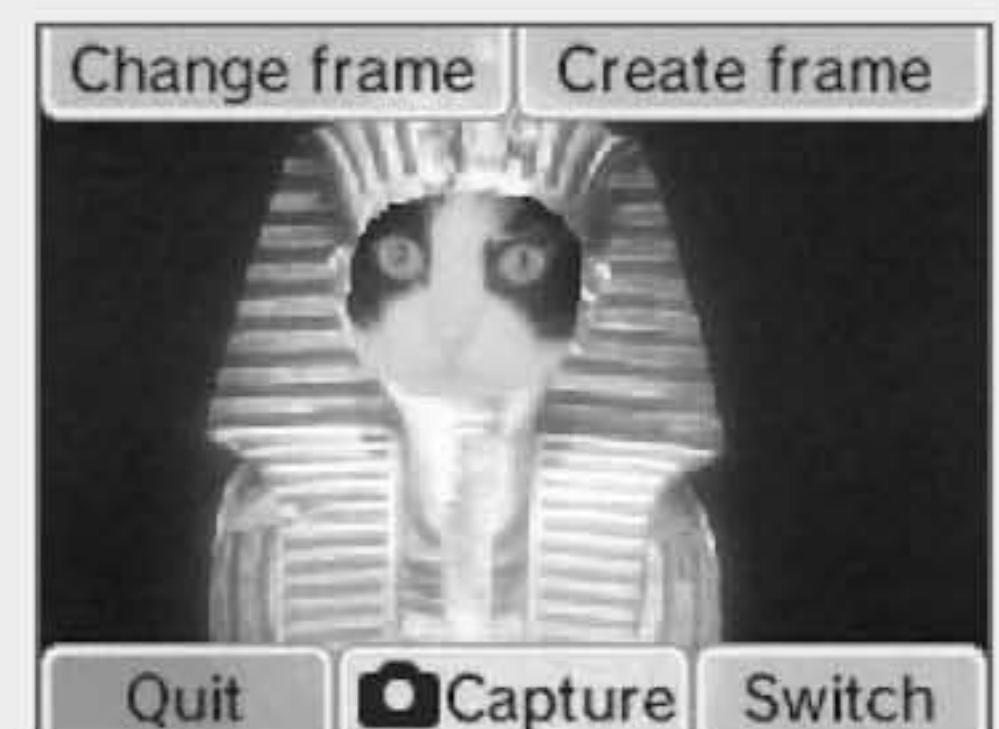

Viewing the Album

Select **ALBUM** from the **Nintendo DSi Camera Menu** to view thumbnails of your photos. You can view, edit or delete any of the photos you have taken.

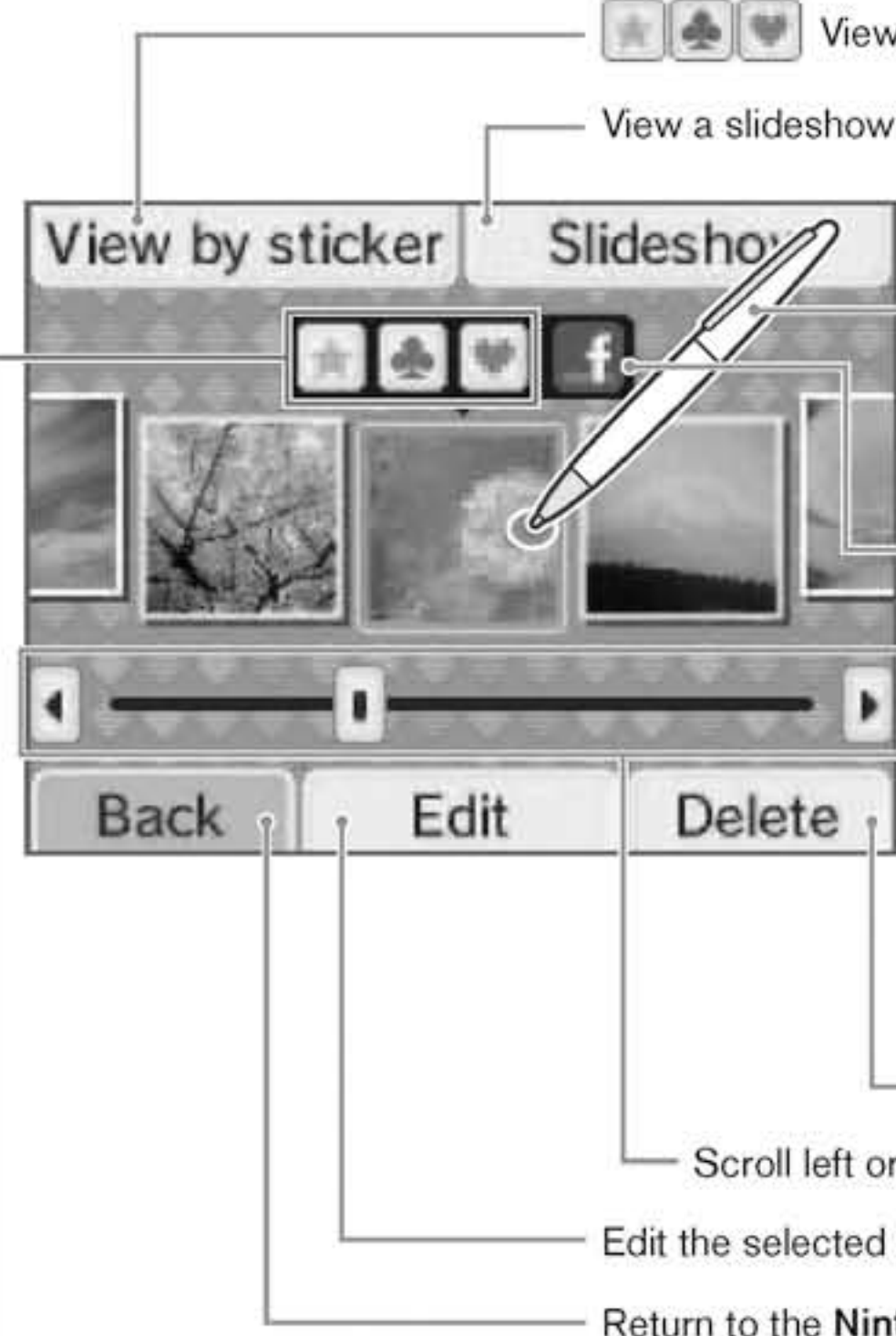

View photos you've marked with stickers

View a slideshow beginning with the selected photo

View by sticker **Slideshow**

On the selected photo...

- Touch → Zoom in
- Slide → Scroll left or right through thumbnails

Upload the selected photo to Facebook™.

- You must register an account with Facebook beforehand.
- Access the Facebook website from a web browser to delete photos you've uploaded.

For more information about Facebook please see [Page 46](#).

Delete the selected photo

Scroll left or right through photo thumbnails

Edit the selected photo using a lens

Return to the **Nintendo DSi Camera Menu** [Page 33](#)

Stickers

You can apply a variety of stickers to your photos to help organise them.

Note: Photos with stickers will appear on the top screen in the **Nintendo DSi Menu**. Photos captured from the **Camera Mode** in **Nintendo DSi Menu** will automatically receive a sticker.

Slideshow

Select **SLIDESHOW** from the **Album Screen** to display photos one after another.

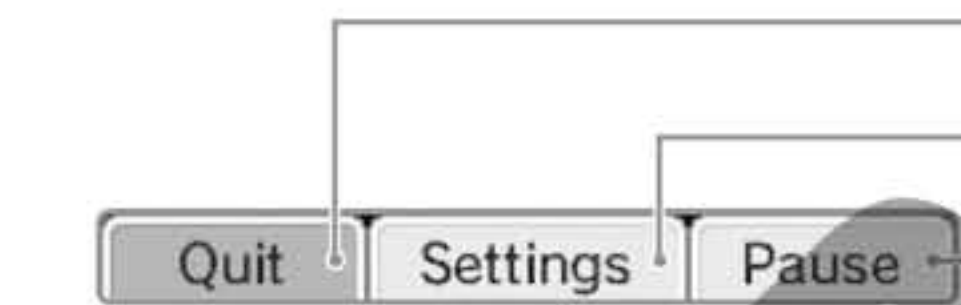

End slideshow

Change display order, display method, and music

Pause/Play slideshow

↑ Options appearing on the Touch Screen

Slideshow Settings



Change the order of photo display

IN ORDER – Display in the order shown in the album

RANDOM – Display in random order

Change the display method

Change the music

Confirm settings and return to slideshow

Order: In order

Display: Movement On

Music: Memories

OK

Quit Settings Pause

About the Thumbnails

- Photos are displayed from left to right in order of oldest to newest. When using **VIEW BY STICKER**, photos are displayed from left to right in the order in which stickers were applied.
- Photos with file formats that cannot be displayed will have a ? icon.
- If you have a lot of photos, it might take a while for all of the thumbnails to appear.

Displaying Photos in the Nintendo DSi Menu

Only photos labelled with a sticker will appear on the top screen of the **Nintendo DSi Menu**. Apply a sticker to any photos you want to display in the **Nintendo DSi Menu**. Remove stickers from any photos you do not want to appear in the **Nintendo DSi Menu**. Photos created using other software will not appear here, even if you attach a sticker to them.

Photo Data

- Only photos taken with a Nintendo DSi/Nintendo DSi XL system can be displayed or edited in Nintendo DSi Camera. Photos taken with a digital camera or mobile phone cannot be displayed, nor can those photos which have been taken on a Nintendo DSi/Nintendo DSi XL system and copied to an SD Card, if the file name, position of the file on the SD Card or content of the file have been altered on a computer or other device.
- Photos taken on a Nintendo DSi/Nintendo DSi XL system contain thumbnail data and photo data. Editing the photos on a computer or other device does not guarantee that the thumbnail data will reflect those changes. As a result, third parties may be able to view unedited thumbnail data if altered photos are uploaded to the internet. Photos modified on a Nintendo DSi/Nintendo DSi XL system reflect those changes in their thumbnails.



Facebook is a trademark of Facebook, Inc.

Viewing the Album

About Facebook

Facebook is a social networking website operated by Facebook, Inc., a company located in the USA, for those aged 13 years and above. Facebook can be used to keep up with family and friends, share photos and socialise. For more details, please see the Facebook website www.facebook.com. The uploaded photos and any other personal data you provide when registering an account with Facebook or when using Facebook is controlled and processed by Facebook, Inc. Please view Facebook's Privacy Policy for further information as to how your personal data is used by Facebook.

For Minors:

Please ask your parents or your legal guardian to explain the Facebook function to you. In particular, you should ask for permission before uploading any photos. Please be aware that the images uploaded onto Facebook will be released on the internet allowing a lot of people to view them. Do not upload any photo that may be illegal, inappropriate, harmful or may violate any third party rights such as portrait rights, privacy rights or copyrights. Especially, if you upload photos displaying people, ensure to obtain their permission beforehand.

For Parents or Guardians:

Please be aware that the images your child uploads onto the Facebook website will be released there allowing other people to view them. As it is important for parents to know about their children's activities on the internet, please see the Facebook website www.facebook.com for more details on Facebook. If you do not want your children to upload photos, you can deactivate this feature via Parental Controls.

Options

Select **OPTIONS** from the **Nintendo DSi Camera Menu** to exchange, copy or delete photos or frames. You can also delete memos here.

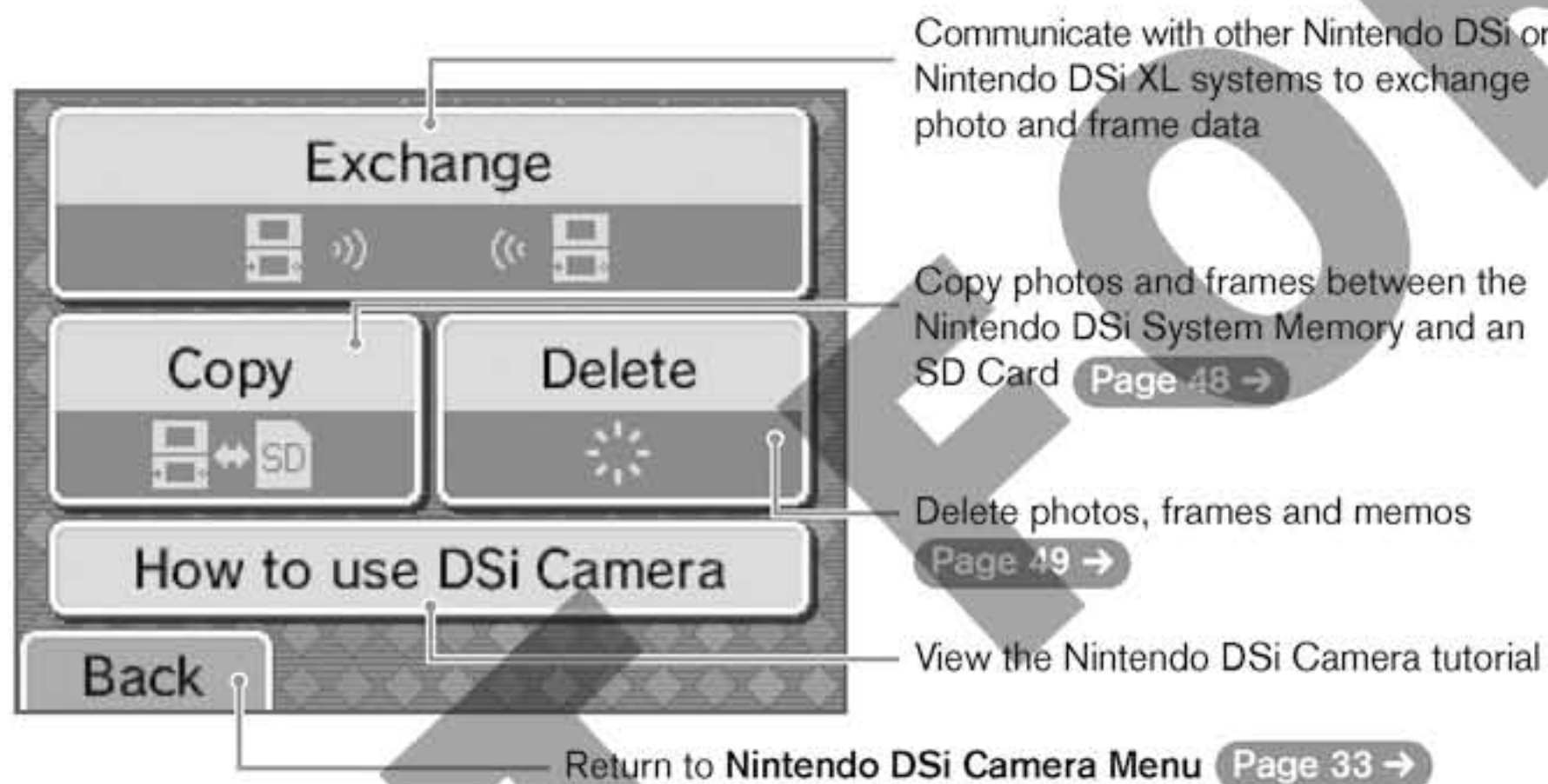

Information about use of Photo and Frame Exchange

Please pay attention to the following regarding the exchange of photos and frames.

- Photos and frames sent using DS Wireless Communications in the Nintendo DSi XL system may be modified and resent by the recipient or other third parties.
- Photos and frames that have been passed on to other users cannot be deleted from the recipient's system by the sender or restricted in use/distribution.
- Please pay sufficient attention to image rights, privacy rights and copyrights when sending photos and frames.

Options

Exchanging Photos/Frames

Communicate with other Nintendo DSi or Nintendo DSi XL systems to exchange photos or frames.

Controls for Sender

- 1 Touch **SEND**. Wait for the recipient(s).



- 2 Select recipients ① then touch **START** ②.



You can send to up to three Nintendo DSi / Nintendo DSi XL systems at once.

- 3 Select where your photo (or frame) is located (either **SYSTEM MEMORY** or **SD CARD**).

Controls for Recipient

- 1 Touch **RECEIVE**.

- 2 Touch a location to save to.



- 3 Touch who you want to receive data from.



Controls for receiving are finished at this stage.

- 4 Select what you want to send.

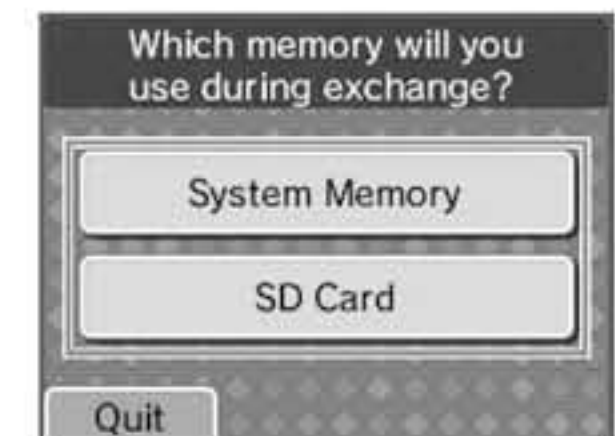

- 5 Select the photo (or frame) to send, then touch **SEND**.

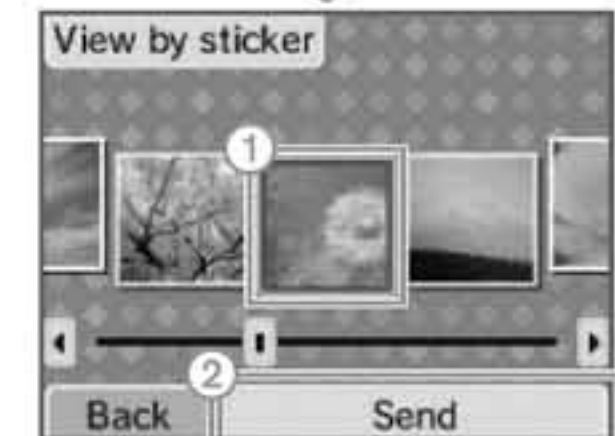

- 6 Select **YES** when you see the confirmation message.

Copying Photos/Frames

You can copy saved photos and frames created on your Nintendo DSi XL system to an SD Card. Providing that you have not altered the photo, or changed the file name or location, you can then copy these back to the System Memory. [Page 45 →](#)

- 1 Select where you want to copy from (SD Card or System Memory).

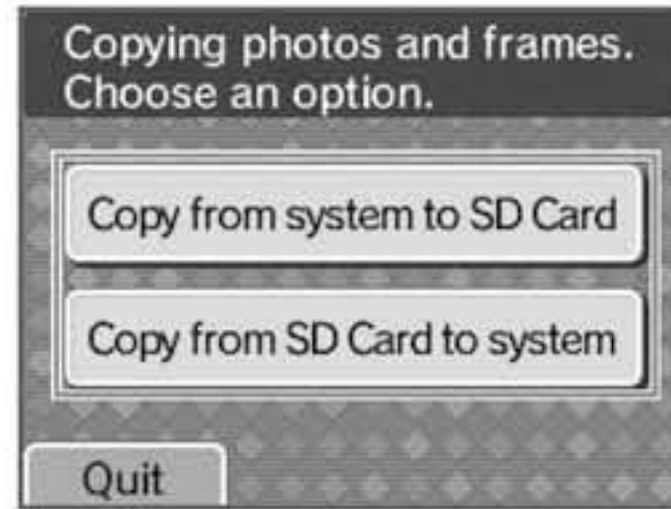

- 2 Select the kind of data you want to copy.



- 3 Select the photos or frames you want to copy.

Note: In this screen, the user has selected PHOTOS.



If you select COPY INDIVIDUALLY, you can select a specific photo or frame from the photo album.

- 4 Select the photo or frame ① and then touch COPY ②.

Note: In this screen, the user has selected PHOTOS.

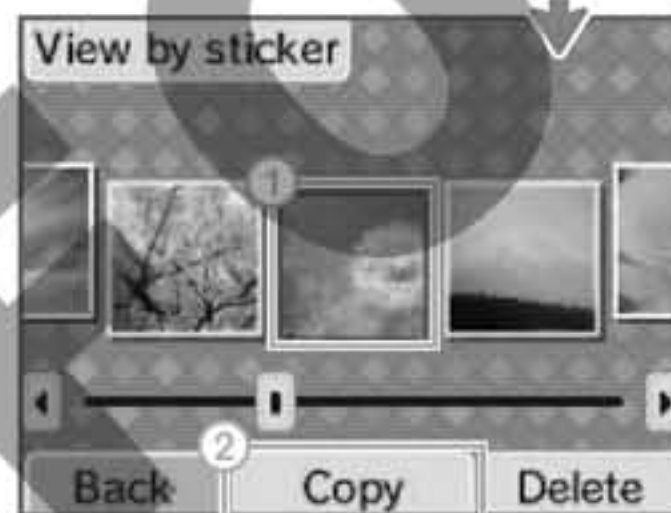

Deleting Photos/Frames/Memos

You can delete photos, frames and memos saved in the System Memory or on an SD Card.

- 1 Select where you want to delete from (SD Card or System Memory).



- 2 Select the data you want to delete.

Note: In this screen, the user has chosen to delete from the System Memory. Since memos can only be saved in the System Memory, the MEMOS option will only appear on this screen.



If you select to delete all memos, select YES on the **Confirmation Screen**.



- 3 Select which photos or frames you want to delete.

Note: In this screen, the user has selected PHOTOS.

WARNING!

If you select ALL PHOTOS, sticker photos or ALL FRAMES, you can quit during the deletion process, but some of the photos or of the frames may still be erased.



If you select DELETE INDIVIDUALLY, you can select a specific photo or frame from the photo album.

- 4 Select the photo or frame ① and then touch DELETE ②.

Note: In this screen, the user has selected PHOTOS.

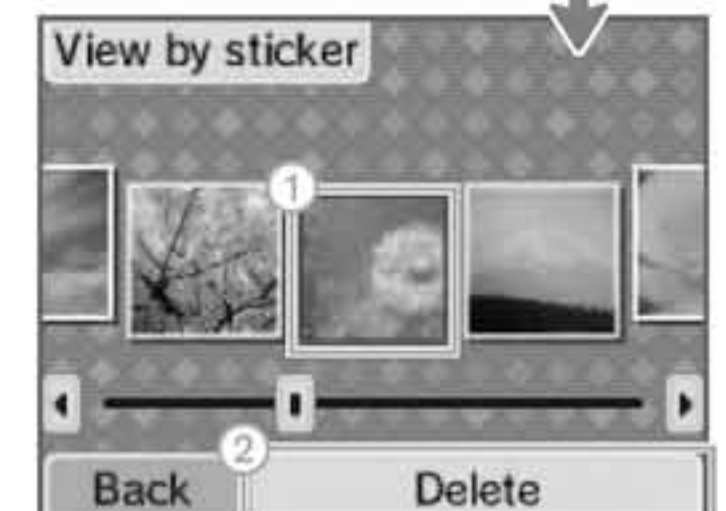

Calendar

Select CALENDAR from the **Nintendo DSi Camera Menu** to access the calendar on the Touch Screen.

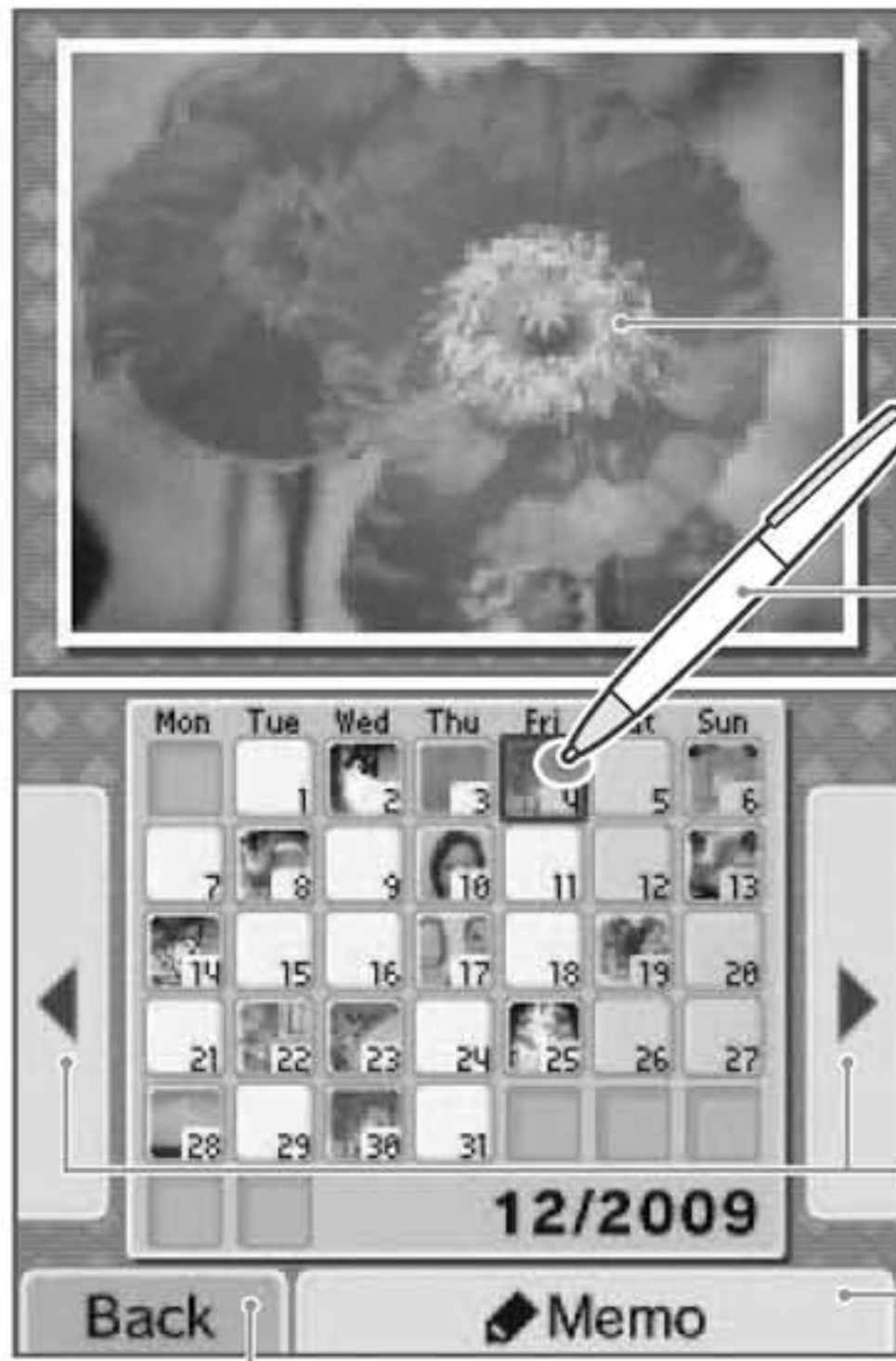

Select a day to view the memo and a photo taken on that day.

If multiple photos were taken on a single day, different photos will be displayed at fixed intervals.

Display the previous or following month

Write a memo for the selected day

Return to **Nintendo DSi Camera Menu**
Page 33 →

Writing Memos

You can write a handwritten memo for each day, whether it's a note about a special event or a reminder about when those photos were taken. All memos are saved in the System Memory.

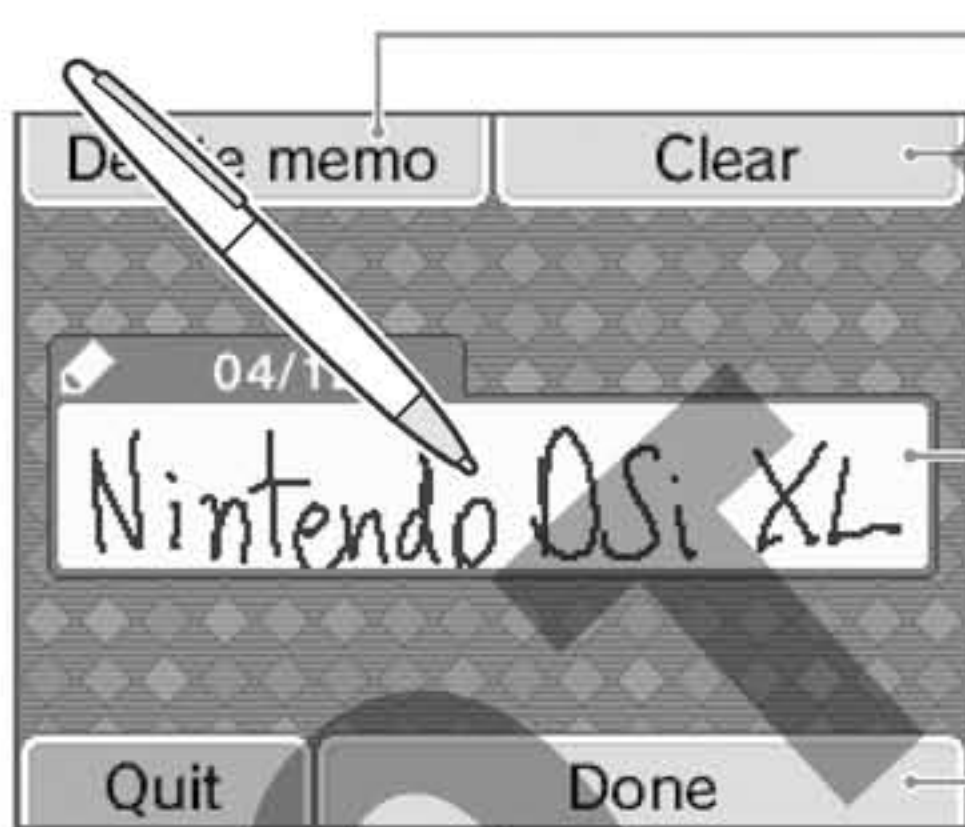

Delete the existing memo

Clear and rewrite the memo

Space for writing the memo

Save the written memo

Nintendo DSi Sound

With Nintendo DSi Sound, you can record sounds using the microphone and then play with them to create new sounds. You can also play with music saved on an SD Card.



Starting Nintendo DSi Sound

When you start Nintendo DSi Sound, you will see a sound wave on the top screen and selectable options on the lower screen. Touch an option to begin playing with sound.

Nintendo DSi Sound Menu

Record sounds with the microphone and play with them [Page 52 →](#)

Play with music files* saved on an SD Card [Page 57 →](#)



Close Nintendo DSi Sound and return to the **Nintendo DSi Menu** [Page 28 →](#)

Adjust settings or delete Nintendo DSi Sound data [Page 60 →](#)

This is your budgie. It will try to imitate any voices and sounds it hears. It also remembers recordings you've made earlier and may repeat them at random.



*Playable File Formats

The following file formats can be played in Nintendo DSi Sound:

AAC files with .m4a, .mp4 or .3gp filename extensions
Bitrate: 16 kbps – 320 kbps
Sampling rate: 32kHz – 48kHz

Note: MP3 files are not supported.

For information on how to save music to an SD Card, see [Page 60 →](#).

Recording and Playing with Sounds

Touch RECORD AND EDIT SOUNDS from the **Nintendo DSi Sound Menu**.

Note: Sound data will be saved in the Nintendo DSi System Memory. No data will be written to or read from your SD card.

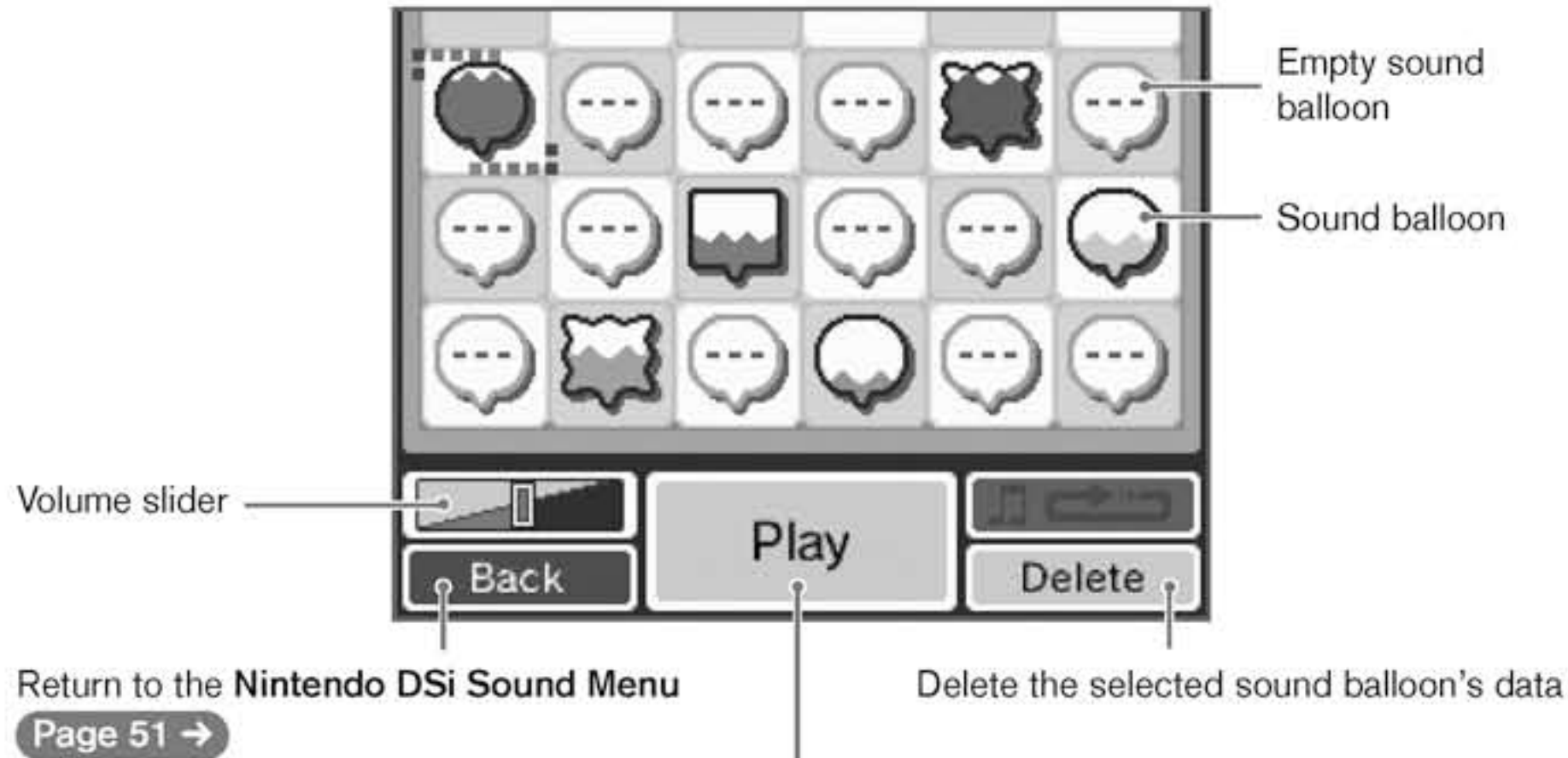

While an empty balloon is selected

Record Use the microphone to record a sound. Each balloon can hold up to ten seconds of sound.

While a balloon with data is selected

Play Play with your sounds by changing the playback speed, applying filters, etc.
Page 54 →

Moving Data into Different Locations

1 Touch the balloon you want to move, and then slide it to a different location and release it.

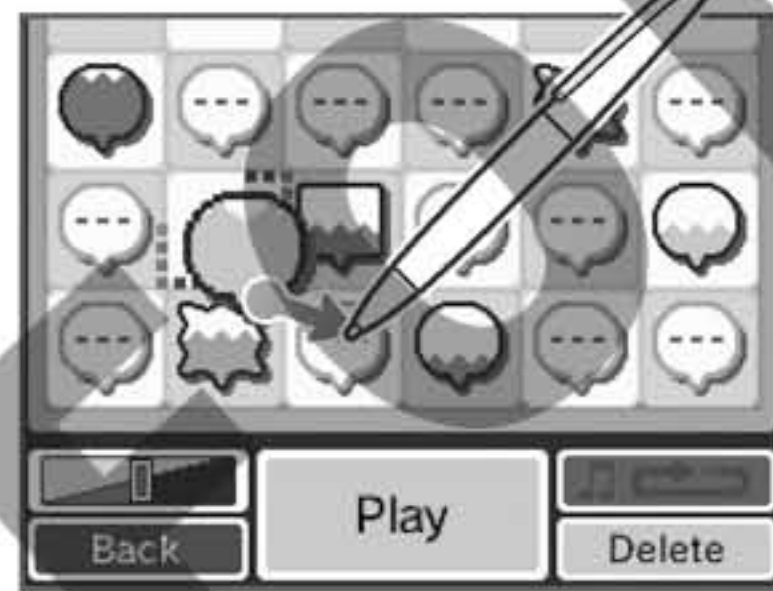

2 The two balloons will swap locations.

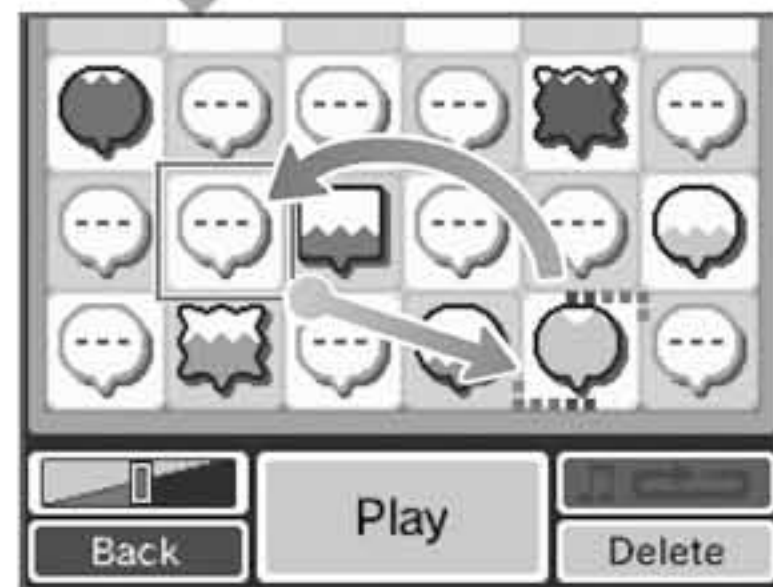

Recording

1 First, touch an empty balloon ①, then touch RECORD ②.



2 Touch  to begin recording. If the microphone detects a loud enough sound, it will begin recording automatically.



3 Once you've finished recording, touch OK. The sound balloon will be given the colour you touch.

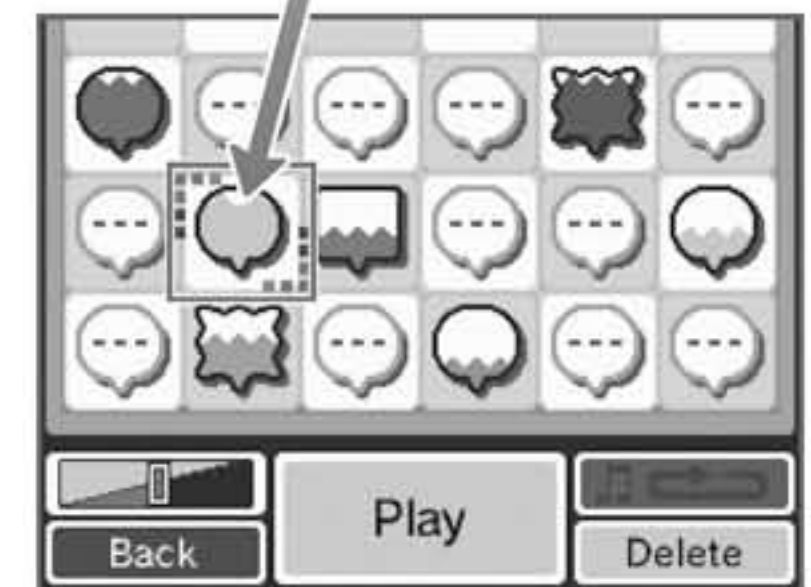
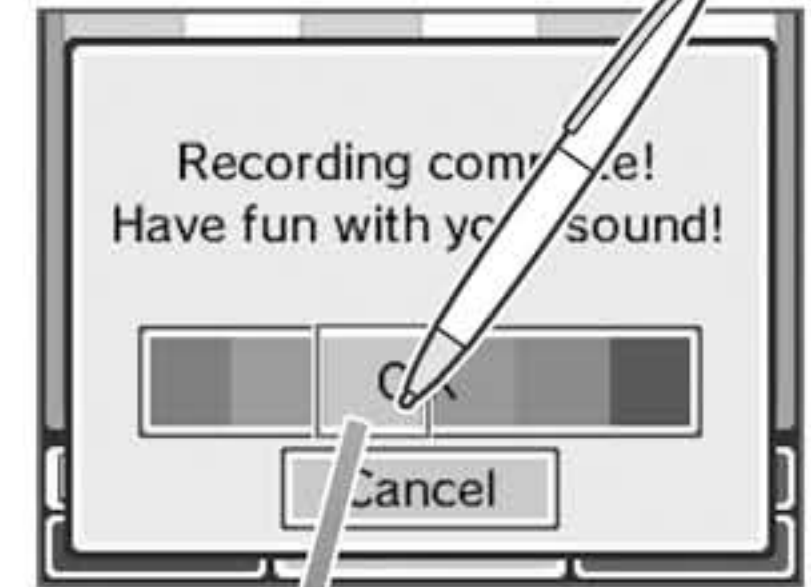

Playing with Sound

- 1 First, touch the sound balloon you want to play with ①, then touch PLAY ②.

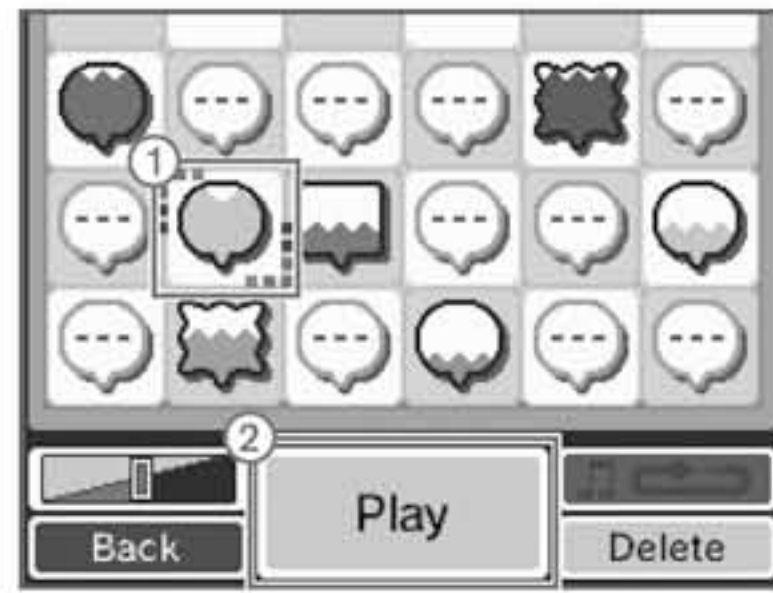

- 2 Change the sound however you like.

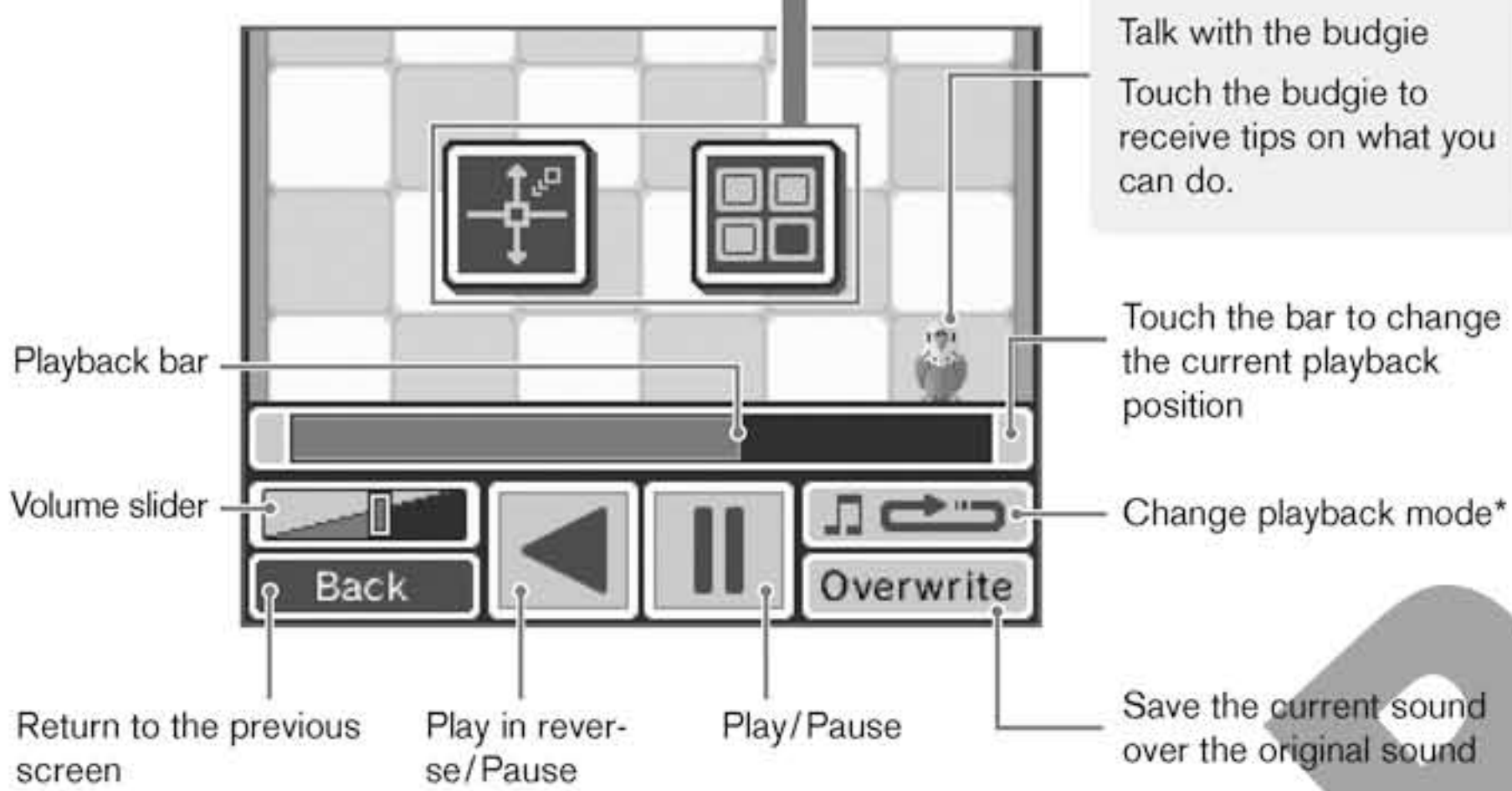

*Playback Modes

- Repeat the current sound.
- Play all sounds in order, then repeat from the beginning.
- Play the current sound once.
- Random play.
- Play the current sound between points A and B set by the user. Slide points A and B back and forth to adjust them.

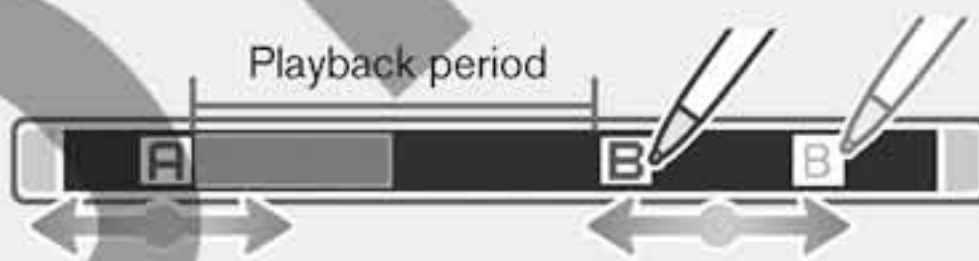

Changing Playback Speed and Pitch

Touch the Touch Screen to move and alter the speed and pitch of the sound.

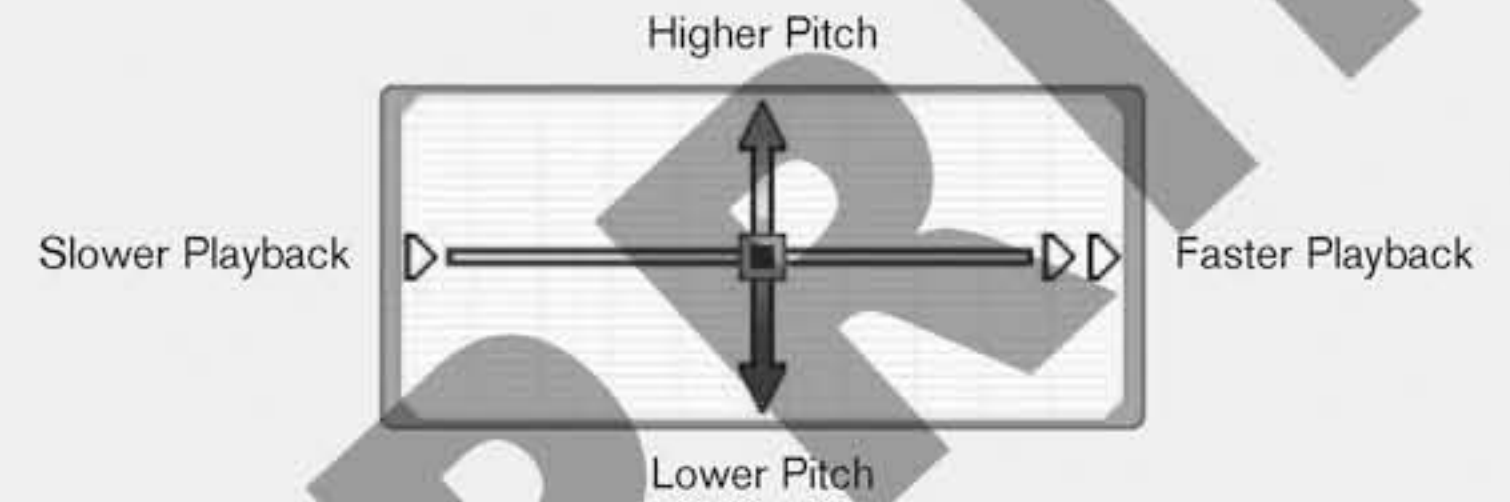

Using Sound Filters

By touching an icon, you can apply different filters to alter your sound. Each icon has three different filters, so each time you touch one, the filter will change.

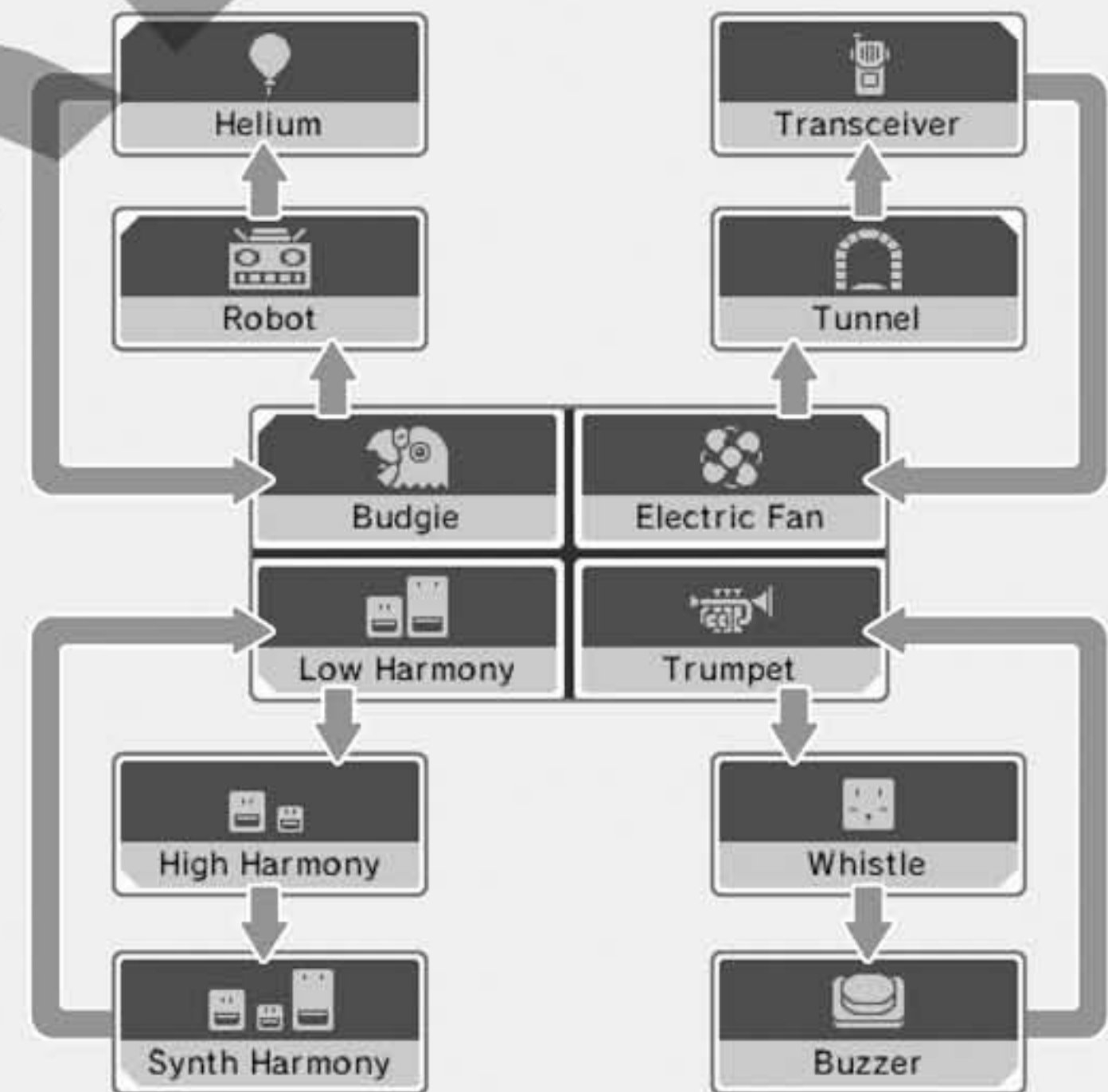

Recording and Playing with Sounds

Saving Altered Sounds

- 1 If you want to save sounds that you've changed, touch OVERWRITE.



- 2 Confirm that the recording sounds the way you want it.



- 3 Touch OK.
The sound balloon will be given the colour you touch. The sound will be saved.



Playing with Music on an SD Card

Choose a Song to Play

- 1 First, touch a folder ①, then select OPEN ②.

Select RANDOM to listen to a song chosen automatically.
You can register songs in one of the Favourites lists, such as TOP 10 or MEMORIES.



Touch CLEAR to erase all songs from a Favourites folder.

- 2 First, touch the song you want to listen to ①, then touch LISTEN ②.



Add the currently selected song to one of the Favourites lists.

About Folders and Files on SD Cards

- In Nintendo DSi Sound, only music files and folders containing music files on the SD Card will be displayed. A maximum of 1,000 folders can be displayed.
- If multiple folders on the SD Card have the same name, those song files will all be displayed in one folder with that name.
- Up to 3,000 song files can be displayed.
- If there are more than 100 song files in a single folder, only the first 100 will be displayed.
- Folders and files more than eight levels deep cannot be displayed.
- No matter where the folders are located, they will be displayed in alphanumeric order.

Playing with Music Files

Talk with the budgie

Touch the budgie to receive tips on what you can do.

Change the visualisation on the upper screen.

Touch the bar to change the current playback position.

Volume slider

Return to File Selection Screen

Playback position

Change playback mode*

Next song

Play/Pause

Previous song

*Playback Modes

Repeat the current song.

Play the songs in the folder in order, then repeat from the beginning.

Play songs in one folder in order, then stop when finished.

Play songs in the selected folder at random.

Play the current song between points A and B set by the user. Slide points A and B back and forth to adjust them.

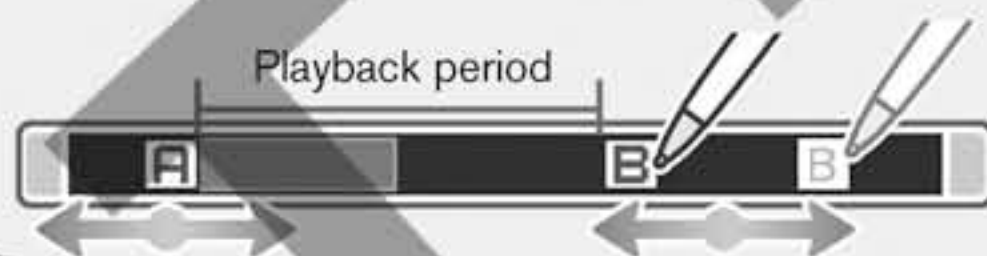

Beat Buttons

Press the L Button and R Button to add sound effects. Touch the icons on-screen to change the sound effects.

Change the playback speed and pitch

Touch the screen to move the and adjust the playback speed and pitch.

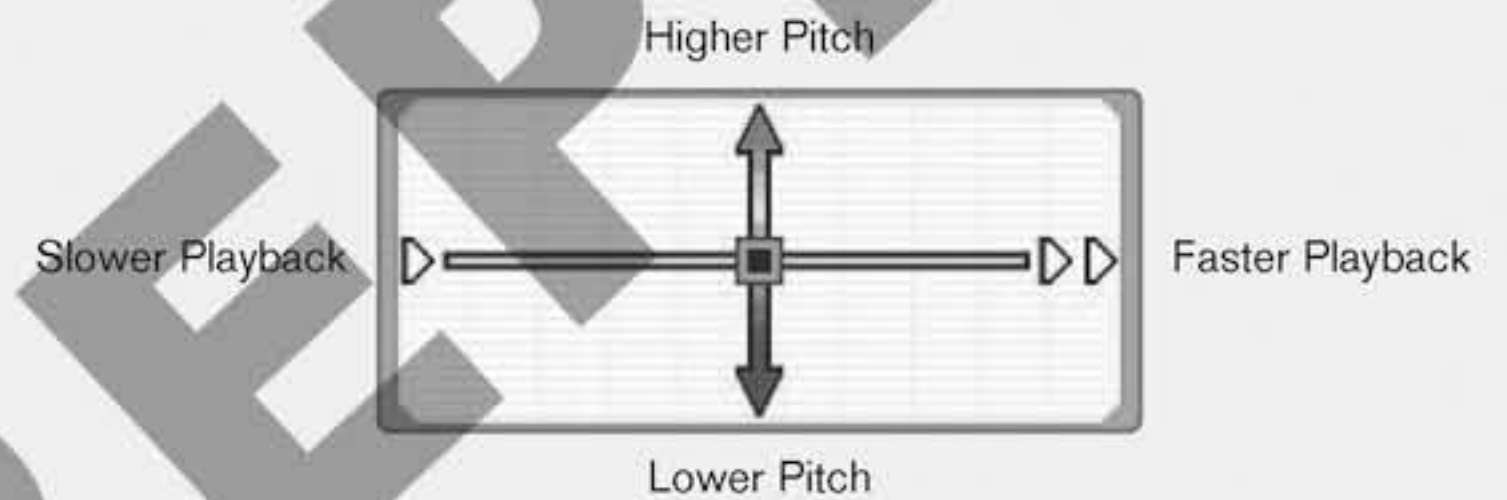

Using filters with the music

Touch an icon to change the filter used on the music.



Makes music sound like it's being played from an old radio.



Removes the vocal range from a track, leaving only the instruments. (In some songs, the vocals may not be entirely removed.)



Adds an echo effect.



Makes your music sound like an old video game!

Layering voice recordings

Touch a sound bubble to start playing it over the music.

Settings

Adjust the settings for Nintendo DSi Sound or format Nintendo DSi Sound Data.

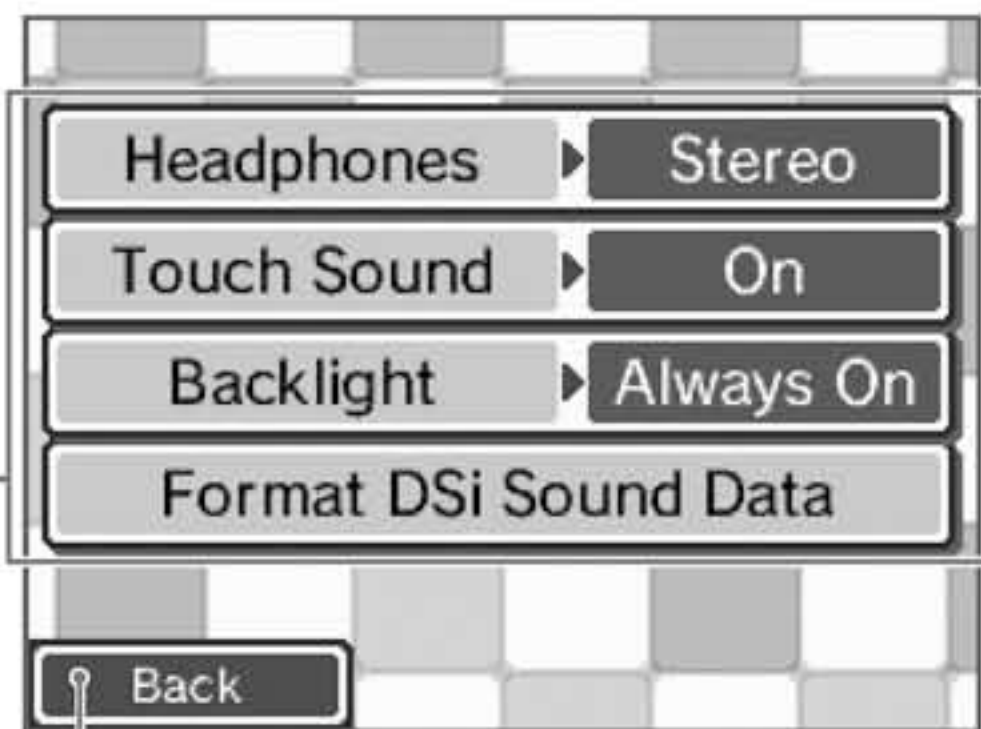

Return to the Nintendo DSi Sound Menu [Page 51](#) →

Headphones ▶ Stereo Set your headphones to MONO or STEREO.

Touch Sound ▶ On Enable or disable Touch Screen sound effects when listening to music in **Play With Your Music Mode**.

Backlight ▶ Always On Set the backlight to turn off automatically when Nintendo DSi Sound is not in use.

Format DSi Sound Data Erase all Nintendo DSi Sound data from the Nintendo DSi System Memory. This will erase all sound files you've recorded or modified, any Favourites you've assigned to your music, and anything the budgie might have remembered.

How do you save music files to an SD Card?

In order to play with music files, you must save music files onto an SD Card. Please follow the steps below to save music files.

- 1 Use software for your computer to copy songs from a music CD and save them in a format compatible with Nintendo DSi Sound. [Page 51](#) →



- 2 Use the SD Card slot on your computer or a commercially-available SD Card reader/writer to place the AAC files on the SD Card.



Note: In the help tips for Nintendo DSi Sound, the budgie quotes lyrics from the following traditional songs: "Twinkle, Twinkle Little Star" (Jane Taylor), "Baa, Baa, Black Sheep" (Traditional) and "London Bridge is Falling Down" (Traditional).

Nintendo DSi Shop

You can purchase Nintendo DSi software via Nintendo DSi Shop.

Before using Nintendo DSi Shop, you must set up an internet connection. [Page 82](#) →



Things you'll need in order to use Nintendo DSi Shop

A broadband internet connection [Page 82](#) →

Nintendo DSi Points

What are Nintendo DSi Points?

You use Nintendo DSi Points to purchase Nintendo DSi software from the Nintendo DSi Shop.

One way to add Nintendo DSi Points to your account is to purchase a Nintendo Points Card and redeem those points in the Nintendo DSi Shop. Those points automatically become Nintendo DSi Points.

For more information about purchasing Nintendo Points, visit support.nintendo.com.



You can redeem Nintendo Points Cards as Nintendo DSi Points.

Purchase

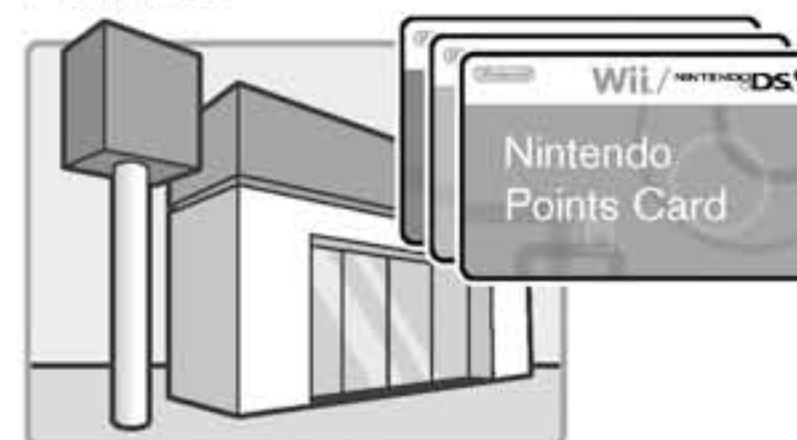

Store selling Nintendo products

Redeem

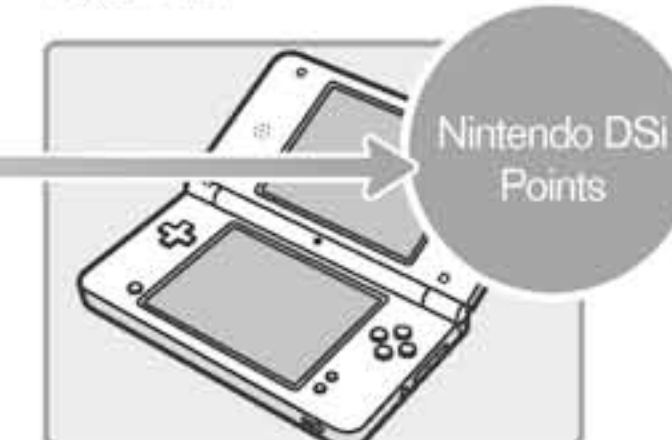

Nintendo DSi XL system

What is a Nintendo Points Card?

This is a prepaid card you can redeem in the Nintendo DSi Shop as Nintendo DSi Points.



How to Redeem Nintendo DSi Points

Use one of the following methods to get Nintendo DSi Points.

■ Redeem a Nintendo Points Card

1 Purchase a Nintendo Points Card.



2 Reveal the Nintendo Points number

Note: Reveal the number on your Nintendo Points Card by scratching off the silver area on the back of the card.



3 Start Nintendo DSi Shop.

↓
Select START SHOPPING, then ADD NINTENDO DSi POINTS.

↓
Follow the on-screen instructions to enter the Nintendo Points number.



■ Buy Nintendo DSi Points using a Credit Card

To buy Nintendo DSi Points with a credit card, start the Nintendo DSi Shop.

↓
Select START SHOPPING, then ADD NINTENDO DSi POINTS.

↓
Follow the on-screen instructions.

Nintendo DSi Software and Nintendo Points Cards

- In order to connect to Nintendo DSi Shop, you will need an active broadband internet connection. The first time you connect, you will need to agree to the terms of use in order to access Nintendo DSi Shop.
- Nintendo Points Cards sold in Europe can only be used on systems purchased in Europe.
- You can redeem a maximum of 10,000 Nintendo DSi Points at a time, eg. if you have 9,000 points in your account, you will not be able to redeem a 2,000 Nintendo Points Card.
- You must redeem all of the points on a Nintendo Points Card at once. You cannot divide the points between different systems or redeem them separately.
- Parents or guardians can use Parental Controls to restrict the purchase of software along age rating guidelines, as well as restricting the use of Nintendo DSi Points.
- All points and software downloads are for use only on a single Nintendo DSi / Nintendo DSi XL system and are non-refundable and non-transferable.
- Points have no monetary value and cannot be redeemed for cash or transferred to another system.
- Software purchased with Nintendo DSi Points cannot be returned, refunded, turned into cash or transferred.
- Once Nintendo Points have been registered as Nintendo DSi Points they cannot be registered on a different Nintendo DSi/Nintendo DSi XL system or on a Wii™ console.
- Software downloaded from the Nintendo DSi Shop is licensed to you, not sold. For more information, please refer to the terms of use that can be viewed in the System Settings. [Page 82 →](#)

Please see Parental Controls on [Page 76 →](#) for information about Pan European Game Information (PEGI) Video and Computer Game Software Ratings.

DS Download Play

With DS Download Play, you can download and play certain multiplayer games with other Nintendo DS/Nintendo DS Lite/Nintendo DSi/Nintendo DSi XL users even if you have only one copy of a game. You can also send and receive demos of certain software titles.

Nintendo DSi XL is equipped with RF module (802.11), which has a radiated output power of less than 10 mW e.i.r.p. and a maximum spectrum power density of less than -30 dBW/1MHz e.i.r.p. These parameters can be maintained when operated within a temperature range of 0 to 40 degrees Celsius. In accordance with this, Nintendo DSi XL is categorised as Class 1 equipment according to Commission Decision 2000/299/EC.



Using DS Download Play

Starting DS Download Play (Host)

- 1 In the **Nintendo DSi Menu**, touch the icon of a DS Download Play compatible title.



- 2 Now follow the instructions in the Instruction Booklet of the software title you are using.

Starting DS Download Play (Client)

- 1 Touch the DS Download Play icon in the **Nintendo DSi Menu**.



- 2 Select the panel for the software title you want to download.



- 3 Touch **YES** to begin downloading the software title.



- 4 Now follow the instructions in the Instruction Booklet of the software title you are using.

PictoChat

PictoChat allows you to use your Nintendo DSi system (Nintendo DSi/Nintendo DSi XL) to send and receive wireless messages and drawings from other Nintendo DS system users. PictoChat is not an internet application. You can communicate with up to 15 other Nintendo DS system users within range of your Nintendo DSi system.

The controls of PictoChat for Nintendo DS and DS Lite users are slightly different.



Starting PictoChat

First, the **Chat Room Selection Screen** will appear. Select a chat room to join.



Reception Strength icons

The number in each panel on the left indicates how many people are in that chat room. If the total number of participants is already at maximum (16/16), you cannot join that chat room.

Close PictoChat and return to the **Nintendo DSi Menu**.

Page 28 →

• Parents or guardians can restrict the use of PictoChat by using Parental Controls.

Please see Parental Controls on **Page 76** → for more information.

Reception Strength icons

The  icon (Reception Strength icon) indicates the state of signal reception and displays at four different levels. Stronger signal reception results in smoother transmission.

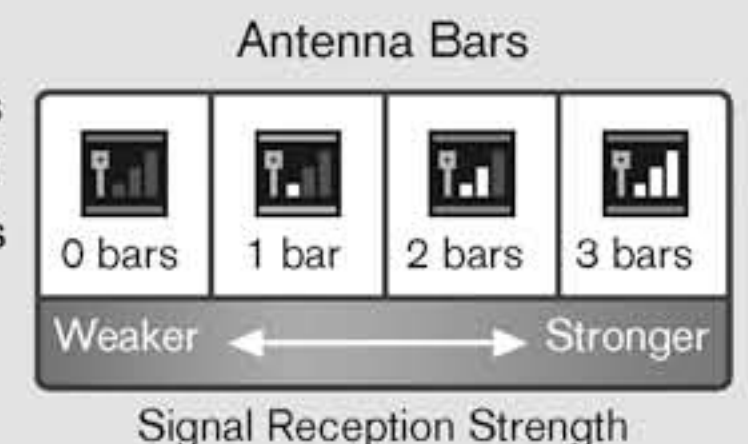

Upper Screen

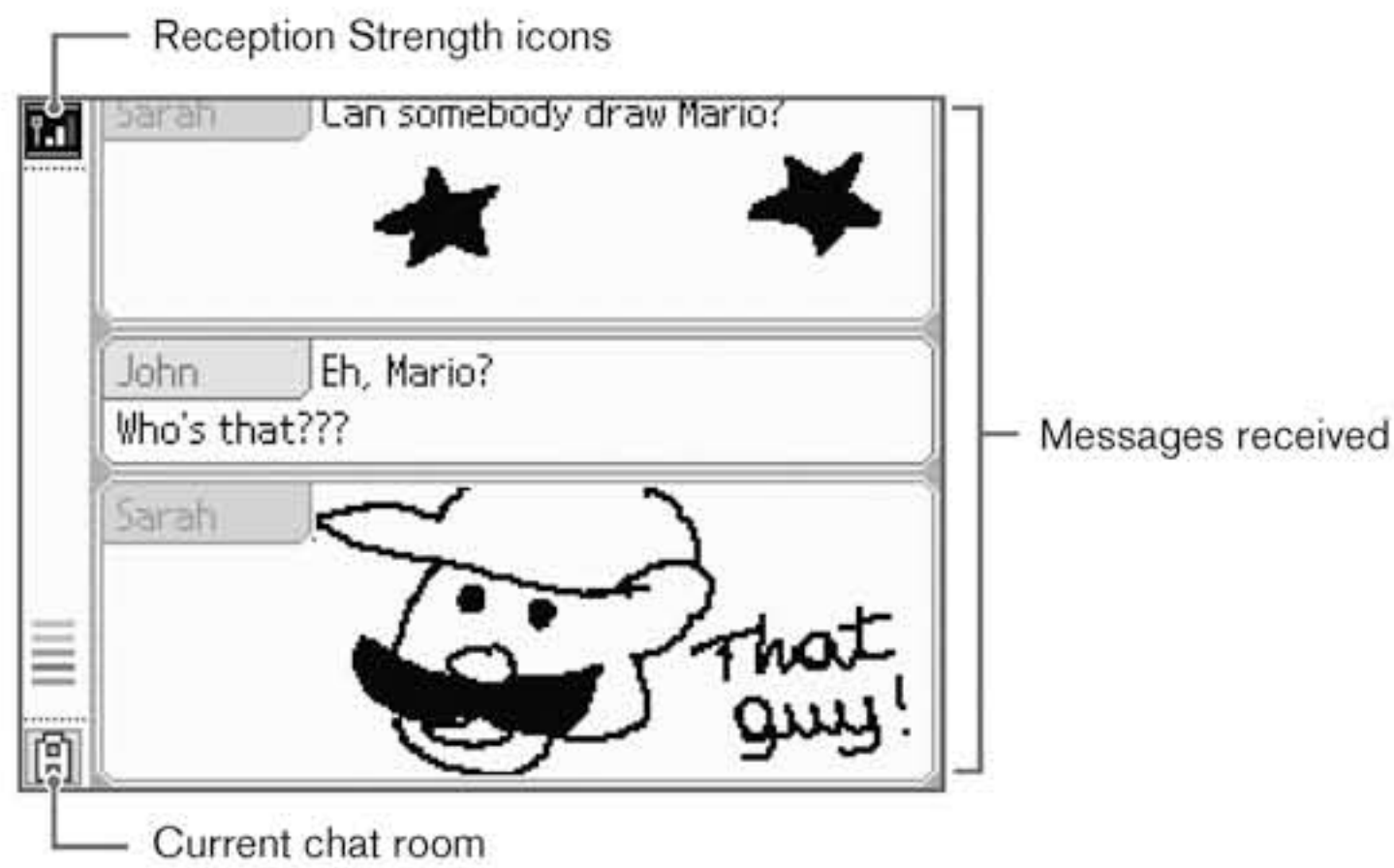

Lower Screen

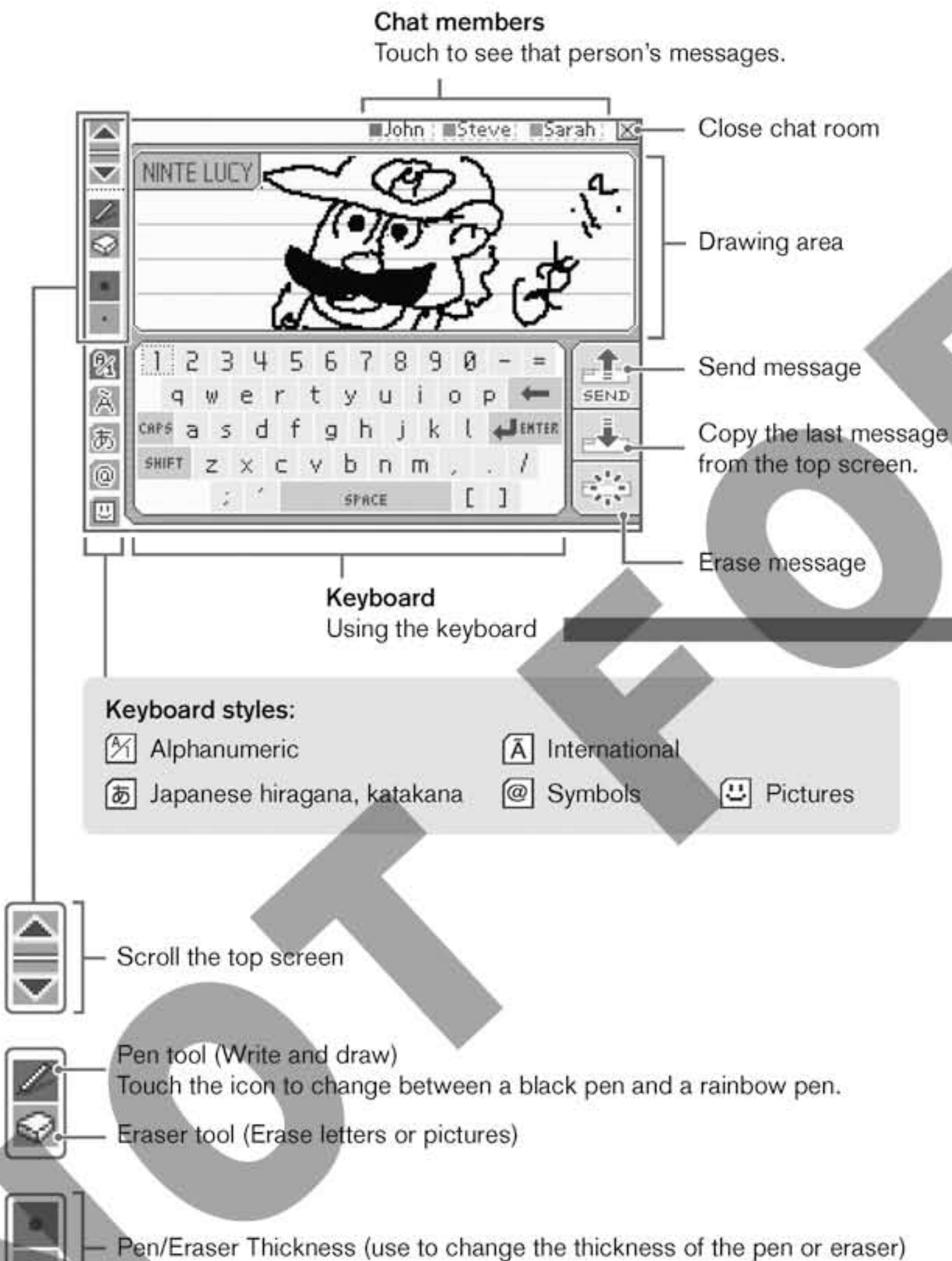

Using the Keyboard

Touch characters on the keyboard to enter them. You can touch and slide letters into the editing area in any order you please.

Alphanumeric

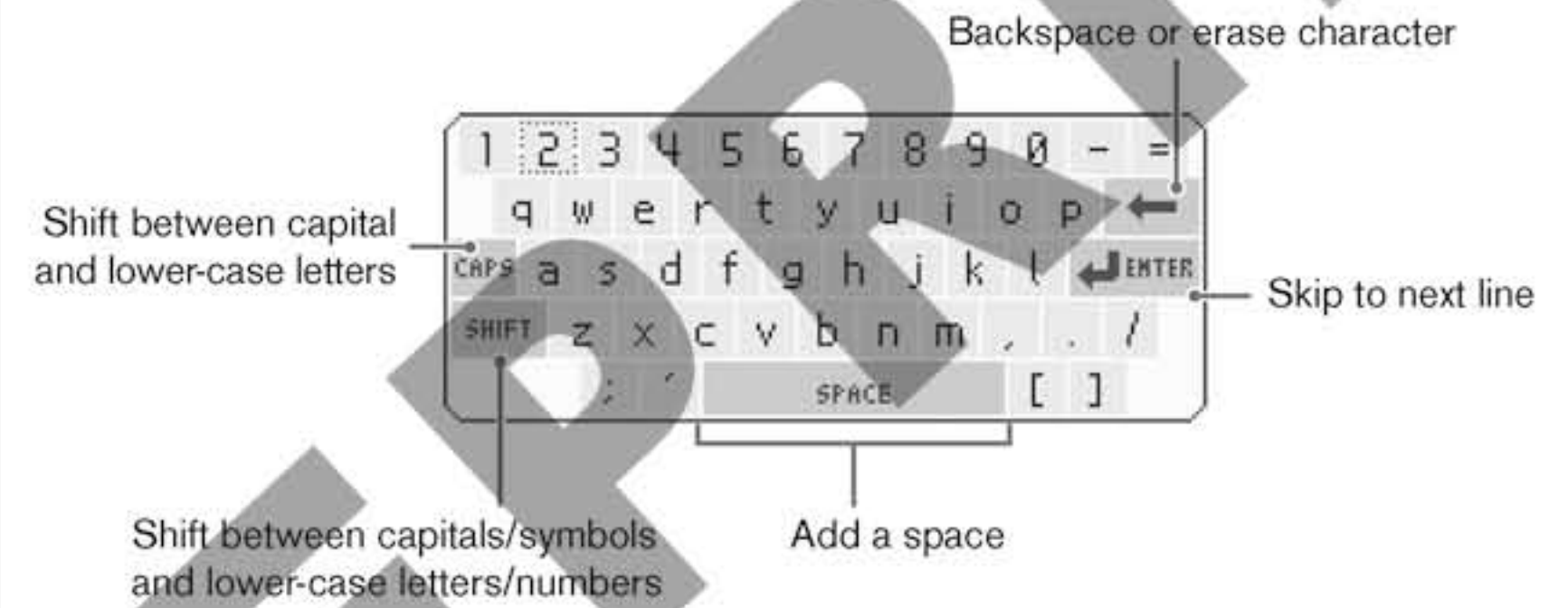

International

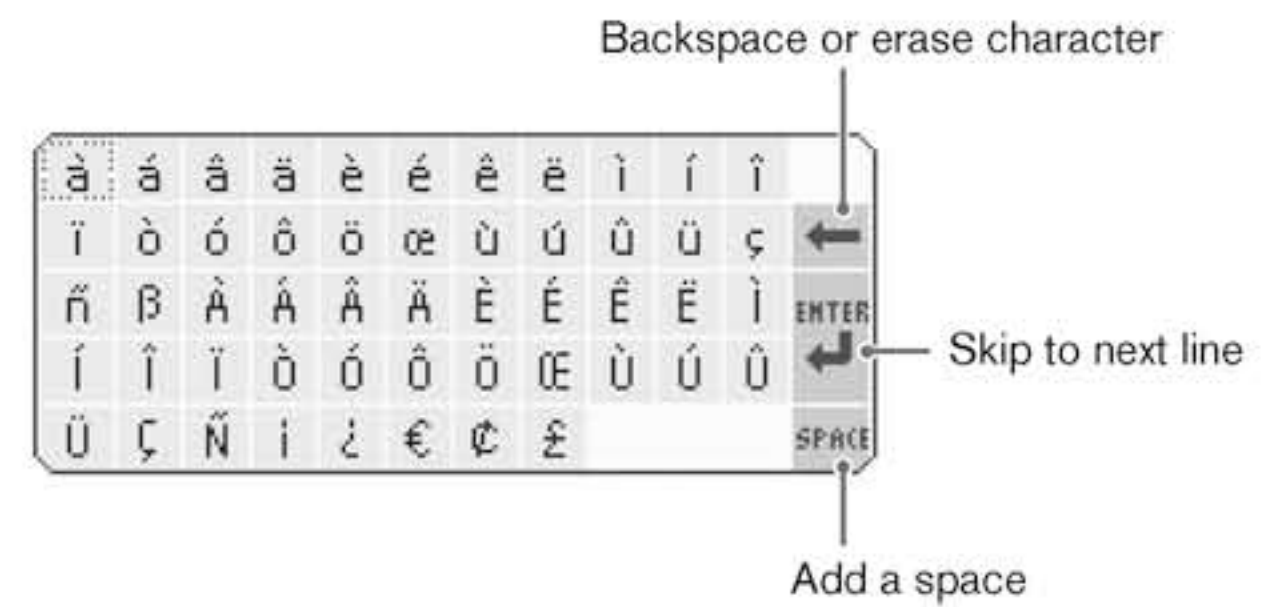

You can also use buttons to control the keyboard.

	Move the cursor
	Enter a character
	Erase the last character entered
	Shift to upper-case letters/Use CAPS
	Switch keyboard types
	Scroll through messages
	Send message
	Press for a short time: Copy last message/ Press for a long time: Erase message

Web Nintendo DSi Browser

Nintendo DSi Browser is a useful application that lets you browse the internet simply using your stylus.

Note: An active broadband connection is required. To use Nintendo DSi Browser, you must first set up an internet connection on your system.

[Page 82 →](#)



Nintendo DSi Browser Instruction Manual

The instruction manual for the Nintendo DSi Browser is included in the software. Please consult it for details on how to use the software.

Accessing the Instruction Manual

- 1 On the **Nintendo DSi Menu**, touch the Nintendo DSi Browser icon.



- 2 Touch **HELP** on the Start Page.



Protecting children from potentially harmful sites

There are two ways to restrict content viewable through Nintendo DSi Browser:

- **Enabling the Parental Controls settings**

Use the Parental Controls function of the Nintendo DSi XL to restrict access to the browser. [Page 76 →](#)

- **Using the Filtering Service**

A fee-based filtering service to prevent potentially harmful sites being viewed can also be used. For further details on the service, go to the **Favourites Screen** and select ASTARO.

System Settings

Select SYSTEM SETTINGS from the **Nintendo DSi Menu** to open the **System Settings Menu**, from which you can adjust many different options. Use ◀▶ to turn pages, and touch the setting you want to adjust.

System Settings 1



DATA MANAGEMENT:

Page 72 →

Manage the System Memory or SD Card data here.
This item will only appear after you have opened Nintendo DSi Shop.

WIRELESS COMMUNICATIONS:

Page 73 →

Turn DS Wireless Communications on or off.

BRIGHTNESS SETTINGS:

Page 73 →

Adjust screen brightness.

System Settings 2



PROFILE:

Page 74 →

Edit your user name, message, birthday and favourite colour.

DATE:

Page 75 →

Set the current date.

TIME:

Page 75 →

Set the current time.

ALARM:

Page 75 →

Set a time for the alarm.

System Settings 3



PARENTAL CONTROLS:

Page 76 →

Set up Parental Controls to limit access to certain content.

TOUCH SCREEN:

Page 81 →

Calibrate Touch Screen input.

MIC TEST:

Page 81 →

Check microphone sensitivity.

INTERNET:

Page 82 →

Configure your internet settings.

System Settings 4



LANGUAGE:

Select a language for your system.

COUNTRY:

Select your country of residence.

SYSTEM UPDATE:

Page 98 →

Update your Nintendo DSi XL system and most built-in applications.

FORMAT SYSTEM MEMORY:

Page 98 →

Delete all added software and save data.

Data Management

Copy and delete software and save data from your System Memory or from an SD Card. When copying data you must insert an SD Card.

Copying/Erasing

- 1 Select where the data you want to delete or copy is located.



- 2 Select the data you want to copy or delete.



- 3 Select either COPY or DELETE.



You cannot copy under any of the following circumstances:

- When there is no SD Card in the SD Card slot.
- When there is not enough space available in the area to which you want to copy.
- When the data you have selected cannot be copied.
- When you want to copy to the **Nintendo DSi Menu** but there are no available boxes.
- When you want to copy to a system that is not where the original data is saved.
- When the SD Card you want to copy to contains 300 blocks or more of software or save data.
- When the SD Card you want to copy to is write protected.

DS Wireless Communications

Turn wireless communications on and off.

Setting DS Wireless Communications

- 1 Simply touch ON to turn wireless communications on and OFF to turn them off.

- 2 Touch OK to confirm.

Note: Make sure you set wireless communications to OFF when on board an aeroplane.



About the wireless indicator LED

When wireless communications are on, the LED will be lit. When data is being transmitted, it will blink.

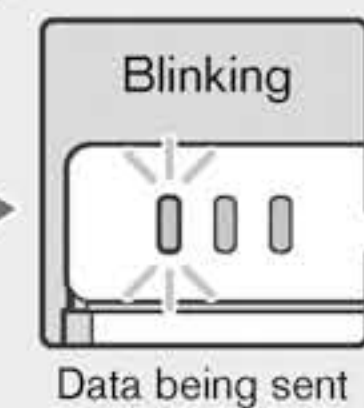
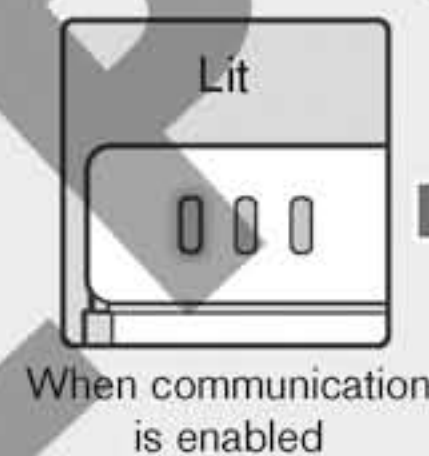

Brightness Settings

Adjust the brightness of the screens.

Adjusting brightness

- 1 Touch + or - to adjust the brightness.

- 2 Touch OK to confirm your adjustments.

While playing a game, you can press and hold SELECT then use the volume control to adjust the brightness.

Use caution when using SELECT to make adjustments as pressing SELECT in certain games may activate game functions or cause the game to skip scenes.

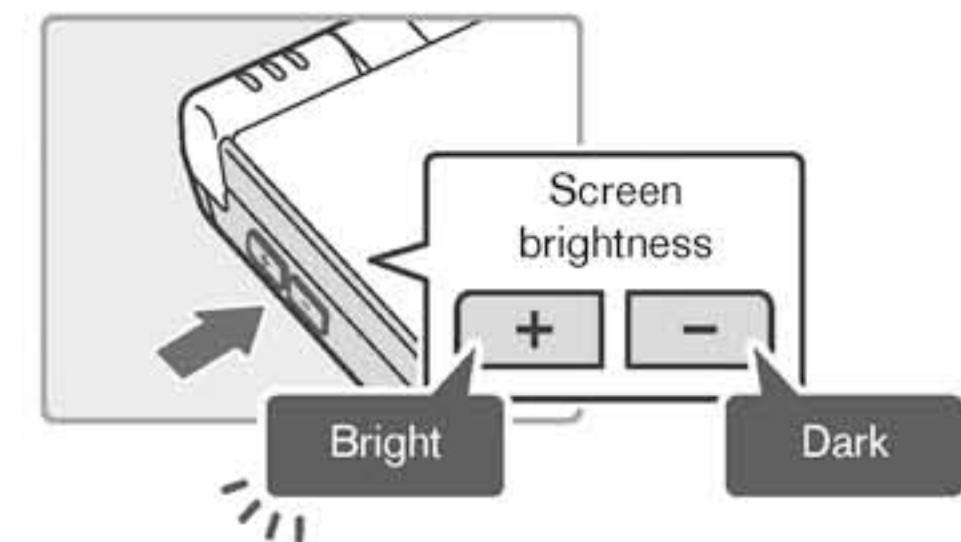
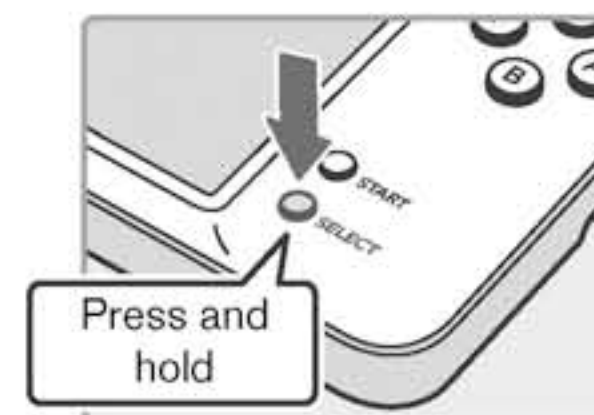

About Screen Brightness and Battery Life

Increasing screen brightness will decrease battery life, and decreasing screen brightness will increase battery life. Please bear this in mind when you adjust your brightness settings. [Page 12 →](#)

Profile

Make adjustments to your user name, message, favourite colour, and birthday.



User Name

- 1 Use the keyboard to enter your user name. See [Page 99](#) for keyboard instructions.

- 2 Touch OK to confirm.



Message

- 1 Enter a personalised message using the keyboard. See [Page 99](#) for keyboard instructions.

- 2 Touch OK to confirm.

The personalised message you enter here will be displayed on other users' systems when using PictoChat, so think about entering a greeting or a short introduction.



Colour

- 1 Touch the colour you like. This colour will be used in various places, such as the **Nintendo DSi Menu**.

- 2 Touch OK to confirm.



Birthday

- 1 Use to set the date of your birthday.

- 2 Touch OK to confirm.



Date

Set the current date.

Some games use this setting, so be sure to enter the correct date.

Setting the date

- 1 Use to adjust the day, month and year.

- 2 Touch OK to confirm.



Time

Set the current time.

Some games use this setting, so be sure to enter the correct time.

Setting the time

- 1 Use to adjust the time.

- 2 Touch OK to confirm.



Alarm

Set a time for the alarm.

Setting the alarm

- 1 Use ① to adjust the time to when you want the alarm, and then touch OK ② to turn the alarm on.

- 2 Touch YES to confirm. Both screens will automatically be set to the lowest brightness setting.



To turn off or cancel the alarm, touch the Touch Screen or any button other than the L and R Buttons.

Once the alarm has gone off, it will enter **Snooze Mode** and the alarm will continue to sound every five minutes until it has been turned off. **Snooze Mode** ends automatically after one hour.

Parental Controls

Parental Controls settings allow parents or guardians to manage what content can be used or downloaded on the Nintendo DSi XL system. Only one set of Parental Controls settings can be enabled per system, so it is recommended that you choose the most secure setting required for your family. You can then share the PIN with users who may be allowed access to blocked content.

What Can Parental Controls Restrict?

- **Nintendo DSi software/Nintendo DSi compatible software**
 - Restrict usage of software based on PEGI/BBFC* rating guidelines. You cannot use this to restrict the use of Nintendo DS software or software downloaded via DS Download Play.
- **PictoChat**
 - Restrict the use of this application.
- **DS Download Play**
 - Restrict the use of this application.
- **Nintendo DSi Browser**
 - Restrict the use of Nintendo DSi Browser to browse the internet.
Nintendo DSi Browser is an internet browser that can be used to view web pages online. If you do not want to allow access to the internet, you should turn the Parental Controls on. If you want to allow limited access to the internet, set up the content filtering service provided by Astaro for Nintendo DSi Browser. For further details on this service, go to the **Favourites Screen** and select **ASTARO**.
- **Nintendo DSi Shop**
 - Restrict the purchase of software using PEGI/BBFC* rating guidelines.
 - Set limits on Nintendo DSi Points usage.
You can only limit Nintendo DSi Points usage, not the purchase of Nintendo DSi Points.
- **Photo exchange**
 - Restrict the exchange of photo data over DS Wireless Communications.
- **Others**
 - Restrict the user-generated content that can be received.



* BBFC (British Board of Film Classification) ratings may be used in certain cases instead of a PEGI rating. For further information about BBFC ratings please visit <http://www.bbfc.co.uk>

Pan European Game Information (PEGI) Video and Computer Game Software Rating Information Icons

Age rating categories



Titles rated 3 are suitable for ages 3 and older



Titles rated 7 are suitable for ages 7 and older



Titles rated 12 are suitable for ages 12 and older



Titles rated 16 are suitable for ages 16 and older



Titles rated 18 are suitable for ages 18 and older

Content descriptors

Content descriptors will be displayed on the software packaging where applicable. The content descriptors indicate content that is determined based on age.



The 'Online' logo indicates that a game allows the player to have access to online game play against other players.

The PEGI system was developed and based on existing systems in Europe. In the drafting of the PEGI assessment form and the shaping of the system organisation, society representatives such as consumers, parents and religious groups have been largely involved. For further information about the Pan European Game Information (PEGI) rating system visit: <http://www.pegi.info>.

Note: This age rating system does not indicate ease or difficulty of a game.

Setting up Parental Controls

- 1 Follow the on-screen instructions.

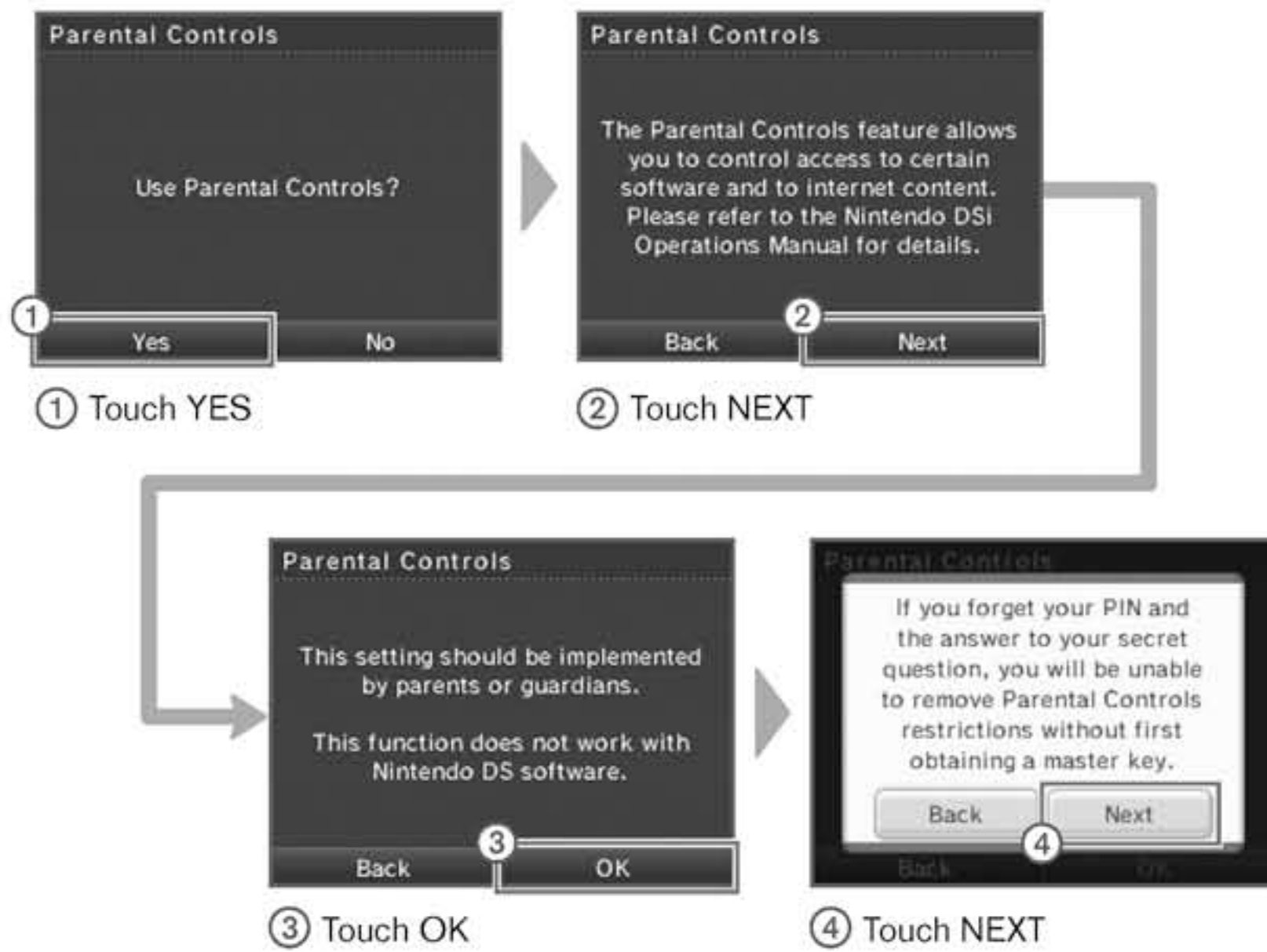

- 2 Enter a four-digit PIN of your choosing, then touch OK. (You will need to enter the number twice to confirm that it is correct.)

You will need this PIN to turn Parental Controls off temporarily or to change your settings. Please remember this number.

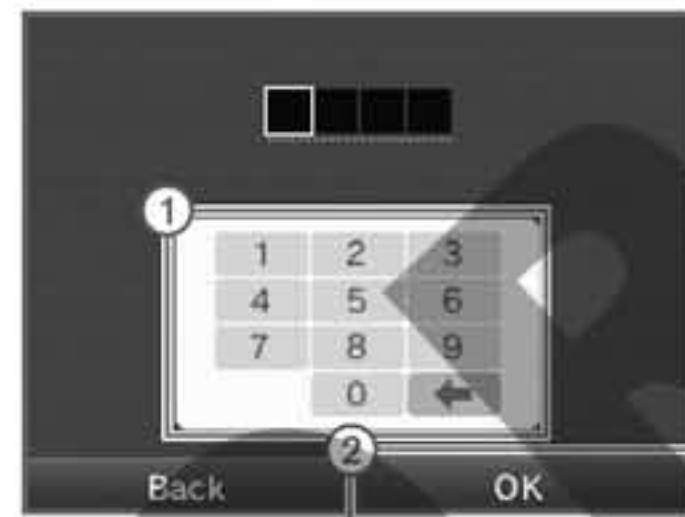

- 3 Use ▲ ▼ to choose a secret question and then touch OK.



- 4 Enter an answer to the secret question and then touch OK. The answer must be six or more characters long.

The answer to your secret question will be used in the event that you forget your PIN, so you should choose an answer you are unlikely to forget.

See [Page 99](#) → for instructions on using the keyboard.



- 5 Now follow the on-screen instructions to set up Parental Controls options.



Parental Controls

If you forget your PIN and the answer to your secret question...

If you forget both your PIN and the answer to your secret question, please follow these steps.

- 1 On the **PIN Input Screen**, select **I FORGOT**.



- 2 On the next screen, enter the answer to your secret question.

If you successfully answer the secret question, proceed with editing your Parental Controls settings.



If you've forgotten the answer to your secret question...

- 3 Select **I FORGOT**.

- 4 An Enquiry Number will be displayed.

Ring the number given in the Nintendo DSi XL Operations Manual and provide the Enquiry Number shown here and the date on your Nintendo DSi XL system. You will then be given further information about receiving a master key.

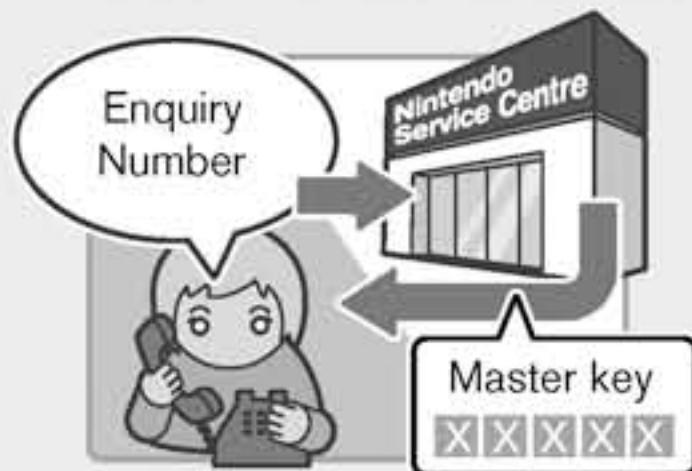

- 5 Touch **OK**.

- 6 Enter the master key and select **OK**.



Touch Screen Calibration

If the Touch Screen is not responding properly or if you feel the stylus contact point is not aligned correctly, take the following steps to recalibrate the Touch Screen.

In the event you are unable to use the stylus at all, press and hold **L Button + R Button + START**, then turn the power on. The **Calibration Screen** will be the first screen to display.

Calibrating the Touch Screen

- 1 Carefully touch the centre of . Calibration points will appear in the upper-left corner, lower-right corner and the centre of the screen. Touch each point to complete calibration.

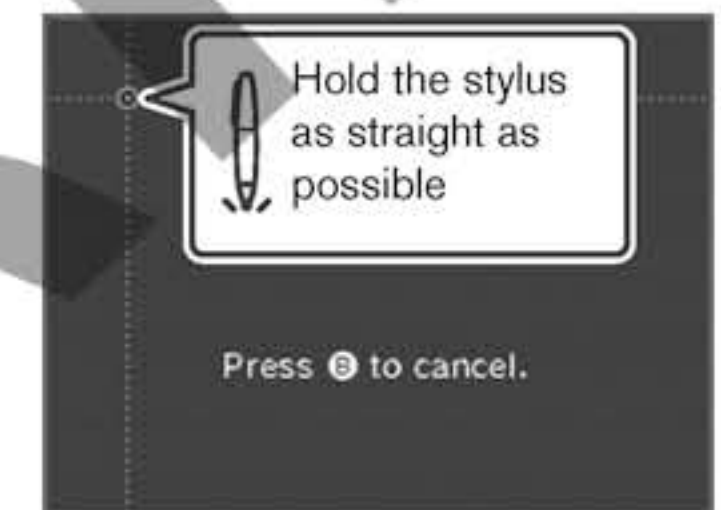

- 2 When **CALIBRATION COMPLETE** appears on the screen, touch each of the four  to confirm.

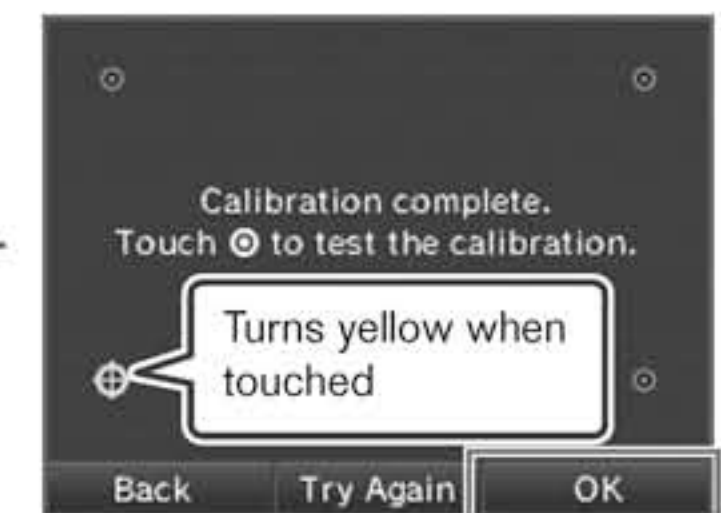

- 3 When you've finished confirming calibration, touch **OK** to finish. If you were unable to accurately touch , select **TRY AGAIN** to restart the calibration process.

Mic Test

Confirm that the microphone is operating properly.

Testing the Microphone

- 1 Face the microphone and speak.



- 2 Confirm that the volume bar fills up with coloured bars. If the volume bar fills with coloured bars when you speak, the microphone is working properly.

The volume bar will fill with coloured bars when it picks up sound.



- 3 Touch **QUIT** when you've finished confirming that the microphone is working.

Internet

Connect your Nintendo DSi XL to a wireless broadband internet connection.

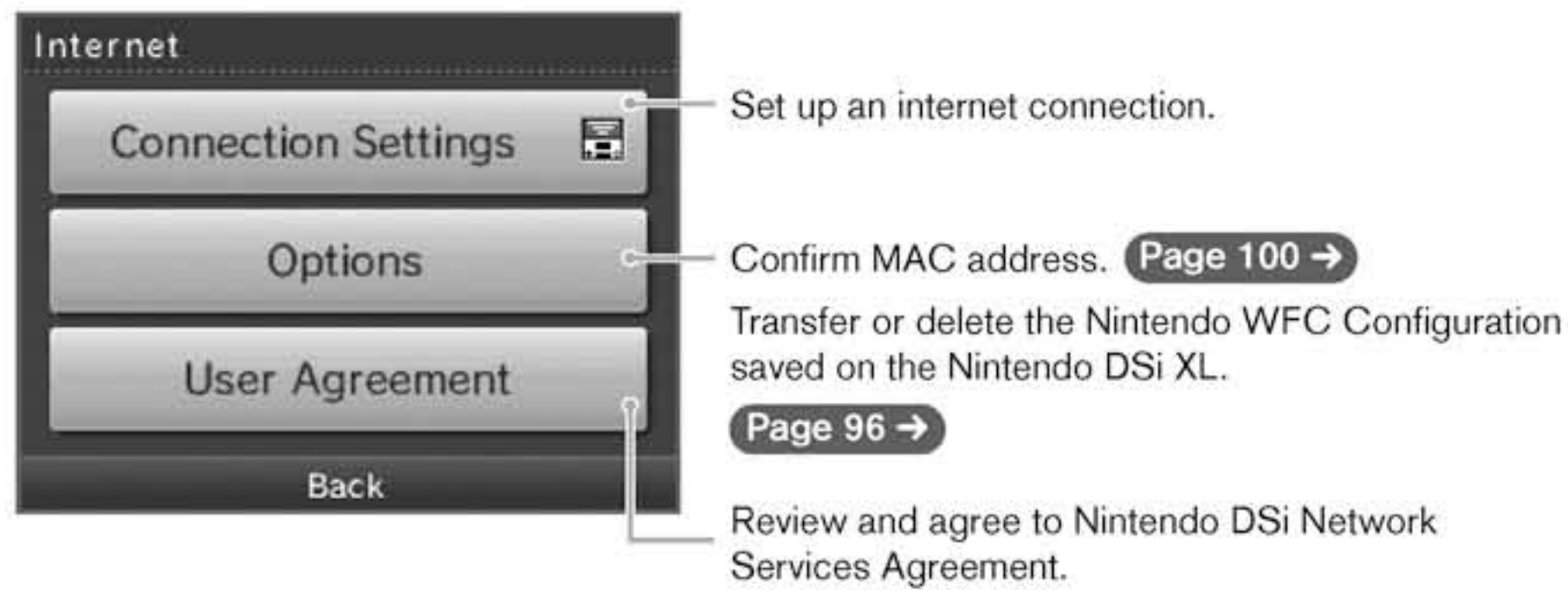

Select setup method

Your connection setup process depends on your home network environment. First answer the following questions, then use the appropriate setup method.

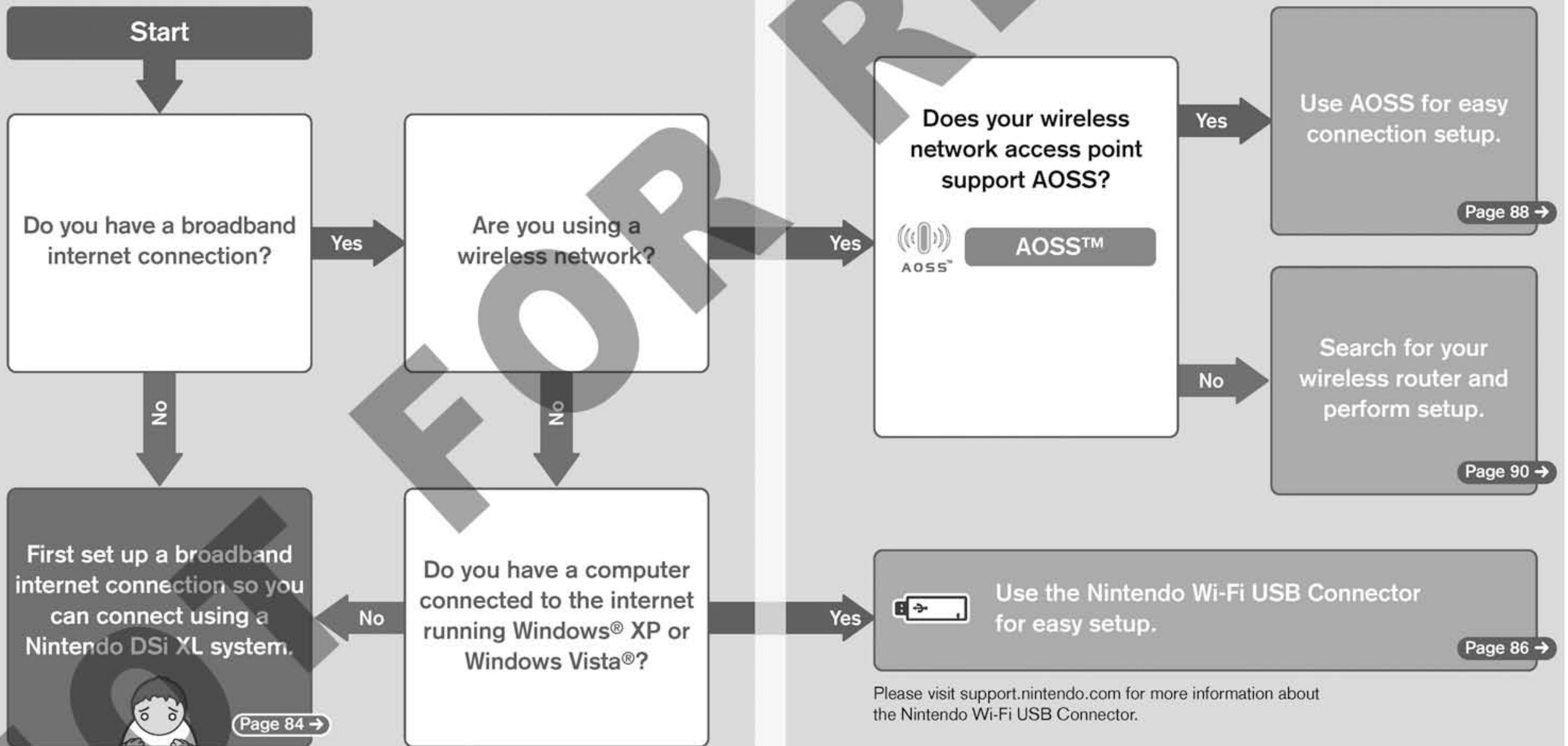

AOSS™ and AOSS™ are the trademarks of BUFFALO INC.
Windows and Windows Vista are trademarks of the Microsoft group of companies.

You can also perform settings for WPA level high security, proxy settings, and settings for advanced users capable of connecting via WPS. [Page 94 →](#)

Connection settings in Advanced Setup (connections 4, 5 and 6) cannot be used with Nintendo DS software. When connecting to the internet with Nintendo DS software, use the usual internet settings (connections 1, 2 and 3).

Setup manually. [Page 92 →](#)

Other settings here

Does your wireless network access point support AOSS?



AOSS™

Use AOSS for easy connection setup.

[Page 88 →](#)

Search for your wireless router and perform setup.

[Page 90 →](#)



Use the Nintendo Wi-Fi USB Connector for easy setup.

[Page 86 →](#)

Please visit support.nintendo.com for more information about the Nintendo Wi-Fi USB Connector.

Required for connecting to the internet

The following are required to connect a Nintendo DSi XL to the internet.

1. Nintendo DSi XL system



2. PC



3. Broadband internet environment using DSL, Cable, etc.



4. Use any of the following devices for connecting your Nintendo DSi XL wirelessly

1

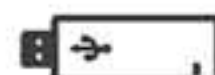

Nintendo Wi-Fi USB Connector [Page 86 →](#)

Even if you don't have a wireless connection in your home, you can connect your Nintendo DSi XL system to the internet by connecting the Nintendo Wi-Fi USB Connector to a USB port of a PC running Windows® XP/Windows Vista® that has a broadband internet connection and is running the software included with the connector.

2



Commercially-Available Access Point
(Wireless Router, etc.)

[Page 88 →](#)

and

[Page 90 →](#)

Note: In this manual, "wireless router access points" are referred to simply as "access points". Please use an access point supporting the 802.11b or 802.11g standards. You cannot use access points supporting 802.11a exclusively.

For a list of access points (routers) that can be recognised by a Nintendo DSi XL system, visit support.nintendo.com.

Even if you don't have a wireless internet environment at home...

You can take your Nintendo DSi XL to a nearby Nintendo DS Centre and connect to the internet without any setup.

 NINTENDO DS
CENTRE

Nintendo DS Centres can be found in electronics retailers.
For more information, visit

<http://nintendodscentre.nintendo.co.uk>

Connecting using the Nintendo Wi-Fi USB Connector (sold separately)

By connecting the Nintendo Wi-Fi USB Connector to a USB port of a PC with a broadband internet connection, you can use the PC as an access point.

Note: Before performing the following settings, install the Nintendo Wi-Fi USB Connector Registration Tool on the computer and launch the program. Refer to the Nintendo Wi-Fi USB Connector Operations Manual for details.



How to Connect

1 Touch CONNECTION SETTINGS.

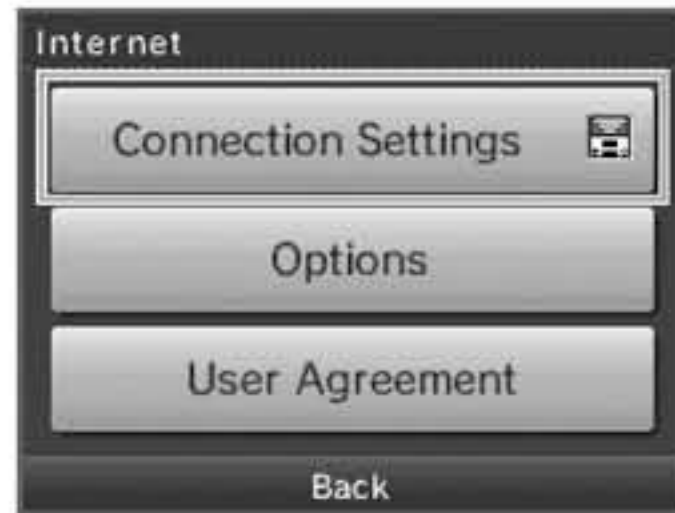

2 Touch NINTENDO Wi-Fi USB CONNECTOR.



3 Confirm that the Nintendo Wi-Fi USB Connector is ready for use and touch NEXT.



4 Proceed to the following PC steps once this screen is displayed.



PC Steps

5 Click on the icon in the notification area of the taskbar.
↓
The Registration Tool is displayed.



6 Select the user name you want to connect from the displayed user names on the Nintendo DSi XL system ①.
↓
Select PERMIT CONNECTION from the displayed menu ②.



Note: The screens shown are from Windows® XP.

Select the user name you want to connect

7 Touch OK to perform a connection test.



If the connection test is successful, setup is complete

Note: If connection fails, refer to the list of error codes in the Support and Troubleshooting section Page 113 → . For more information on the Nintendo Wi-Fi USB Connector, visit support.nintendo.com.

Connecting using AOSS

If your access point supports AOSS, you can use this functionality for an easy connection setup. Also refer to the instruction manual of your access point.

Note: Using AOSS may cause your access point settings to change. If you're connected to a computer without using AOSS, it may no longer connect after using AOSS.

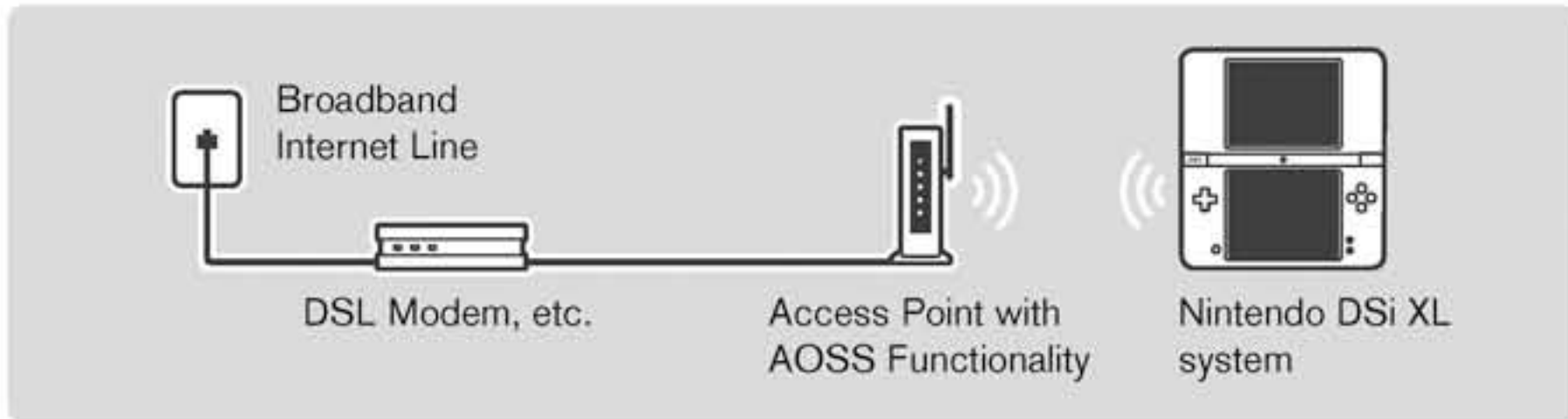

How to Connect

1 Touch CONNECTION SETTINGS.

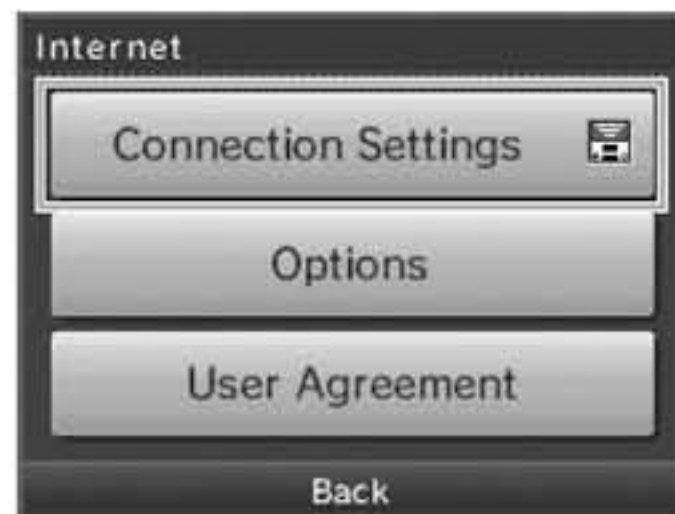

2 Touch an unused connection, indicated by NONE.



3 Touch the AOSS icon.

Proceed to the following access point steps.



4 Access point steps

Using AOSS

Press the AOSS Button until the lamp starts blinking.

Note: If the connection continues to fail when performing AOSS settings, wait approximately 5 minutes and then try again.

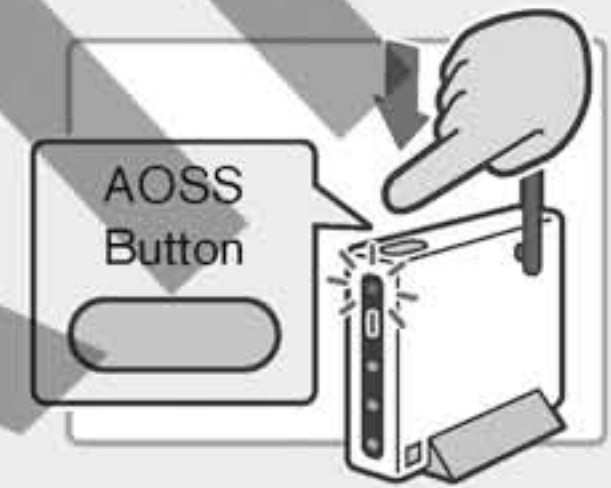

5 Touch OK to perform a connection test.



If the connection test is successful, your settings are complete. Immediately after completing settings for AOSS, the connection may fail due to the restarting of the access point. Wait a short while, then try performing a connection test again.

Searching for and connecting to an access point

You can use this method to search for and connect to an access point if your access point does not support AOSS.

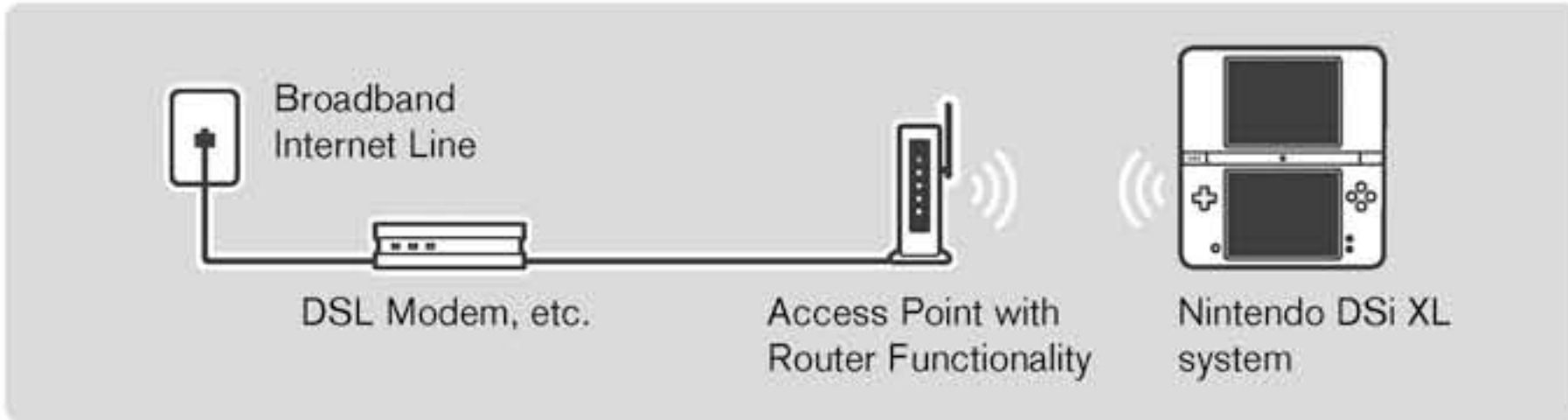

How to Connect

1 Touch CONNECTION SETTINGS.

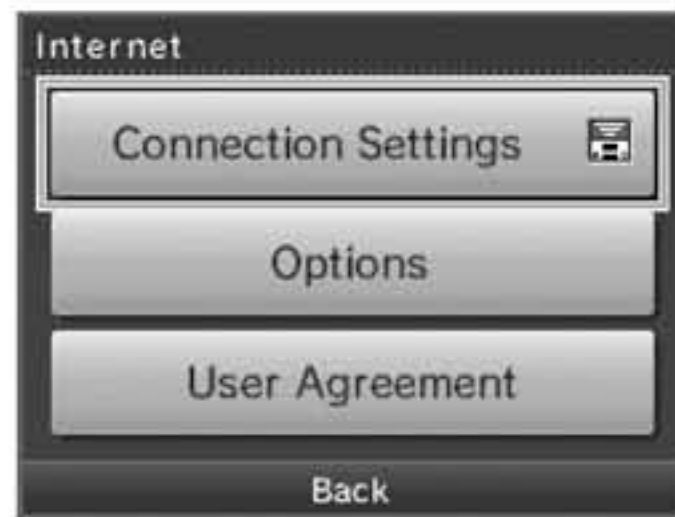

2 Touch an unused connection, indicated by NONE.



3 Touch SEARCH FOR AN ACCESS POINT.



4 Touch an access point to select it.
If no access points are found, try configuring settings manually.
[Page 92](#) →



5 Enter the key and touch OK.
This is displayed only when the access point uses wireless security.



6 Touch OK.



7 Touch OK to perform a connection test.



If the connection test is successful, setup is complete

Note: If the connection fails, refer to the list of error codes in the Support and Troubleshooting section [Page 113](#) → .

Access points marked require that you enter the access point's security key. [Page 100](#) →

Key input not required	Configured with an unsupported encryption format. To connect to access points with this mark, configure settings through Advanced Setup. Page 94 →
Key input required	

The icon (Reception Strength icon) indicates the state of signal reception and displays at four different levels. Stronger signal reception results in smoother transmission.

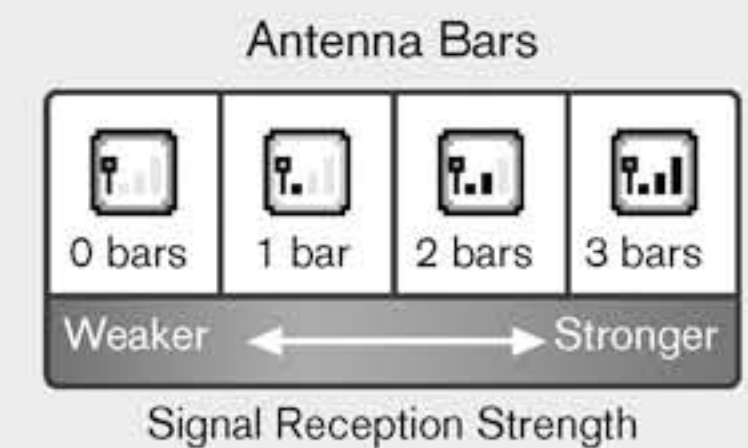

Configuring settings manually

Configure your access point settings manually.

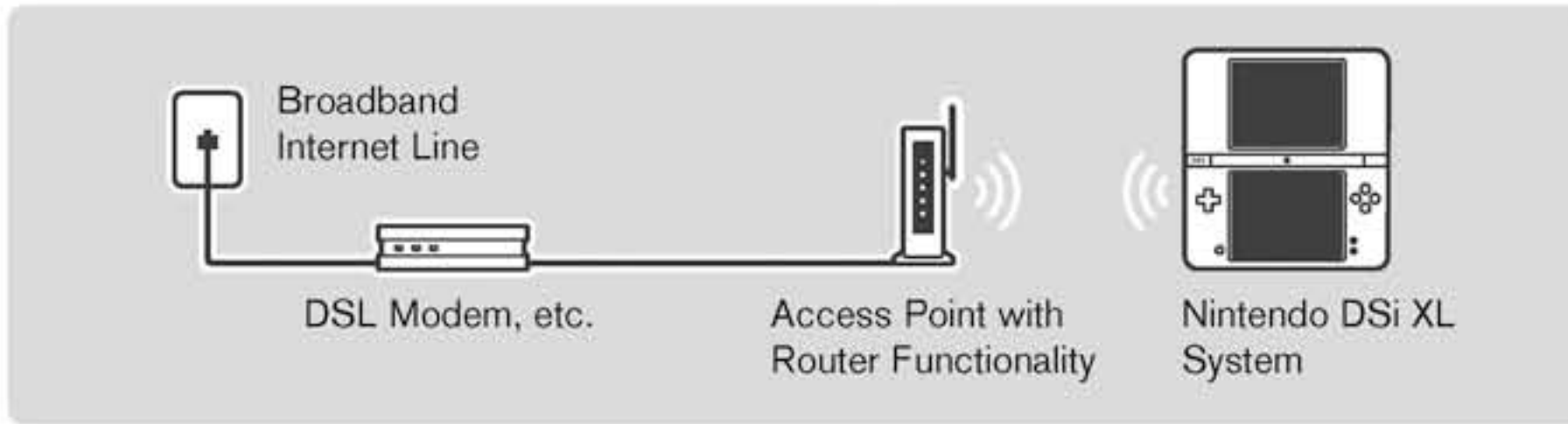

How to Connect

1 Touch CONNECTION SETTINGS.



2 Touch an unused connection, indicated by NONE.



3 Touch MANUAL SETUP.



4 Set each field and touch SAVE when finished. When setting the IP address manually, be sure to also set the DNS.

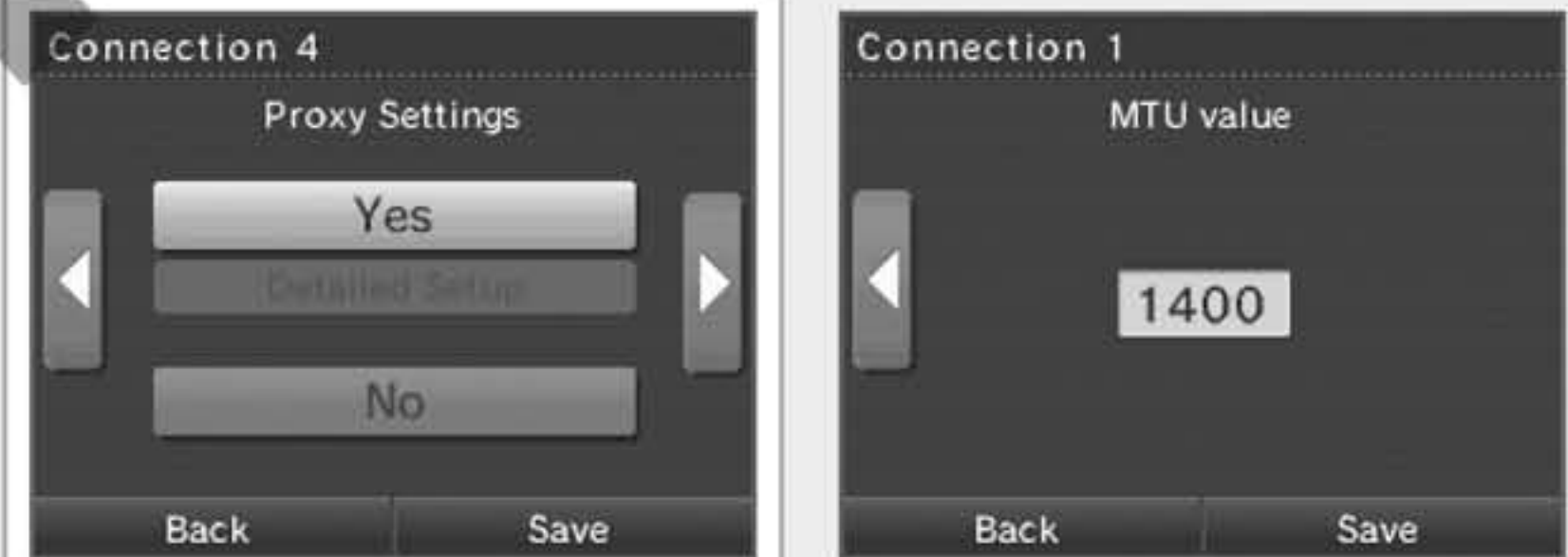
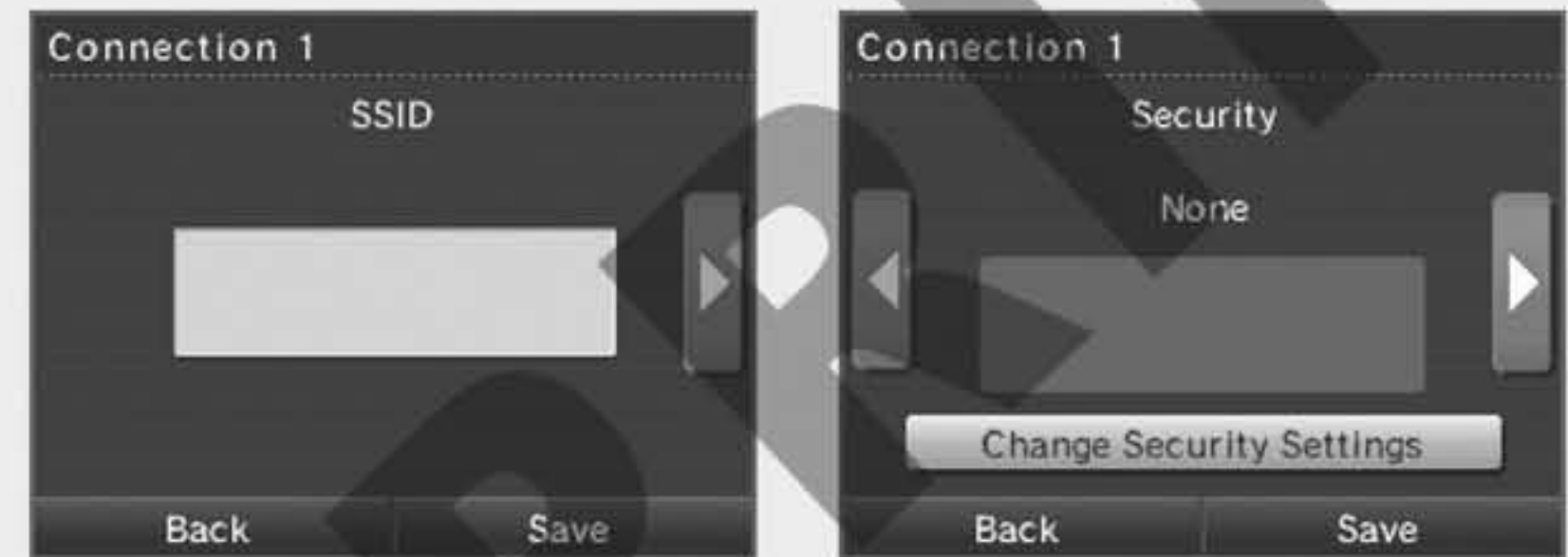

Proxy settings can only be configured when configuring Advanced Setup.

5 Touch YES to perform a connection test.



If the connection test is successful, setup is complete

Note: If the connection fails, refer to the list of error codes in the Support and Troubleshooting section Page 113 → .

Advanced Setup

In Advanced Setup you can configure settings for connecting to the internet using software that supports Nintendo DSi features, using WPA level high security, proxy settings and settings for connecting with WPS. [Page 101 →](#)

Advanced Setup (connections 4 – 6) cannot be used with Nintendo DS software that does not support Nintendo DSi features. When connecting to the internet with Nintendo DS software, configure normal internet settings (connections 1 – 3).

How to Connect

1 Touch CONNECTION SETTINGS.

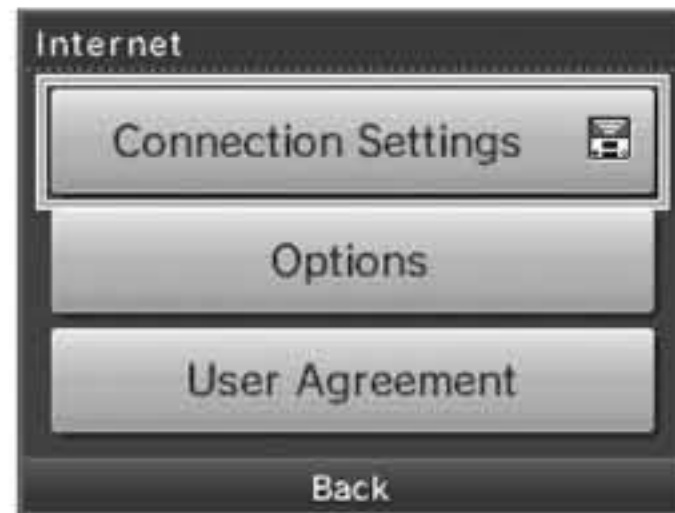

2 Touch ADVANCED SETUP.



3 Touch an unused connection, indicated by NONE.

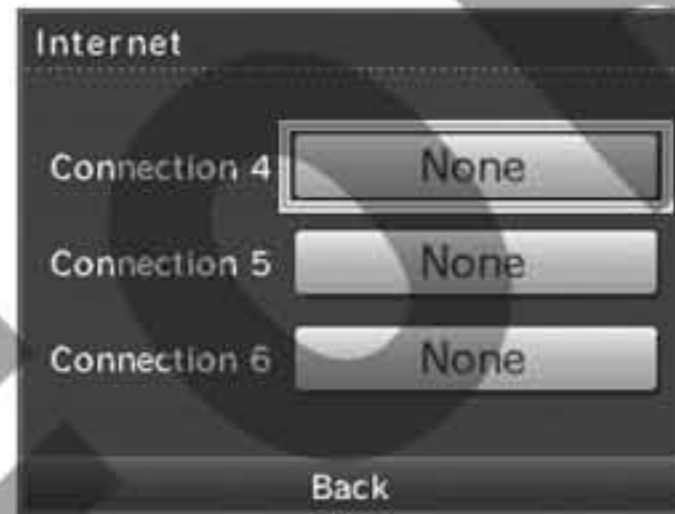

4 Touch the connection method best suited for your connection environment.

To set up using WPS
Touch the WPS icon and proceed from step 5.



- Using AOSS [Page 88 →](#)
- Searching for an access point [Page 90 →](#)
- Manual setup [Page 92 →](#)

Note: Unless you are using WPS, the rest of the procedure is the same as for configuring normal settings.

5 Touch the connection type best suited for your access point.



6 Access point steps

Push-Button Connection
Continue to push the WPS Button until the lamp blinks.

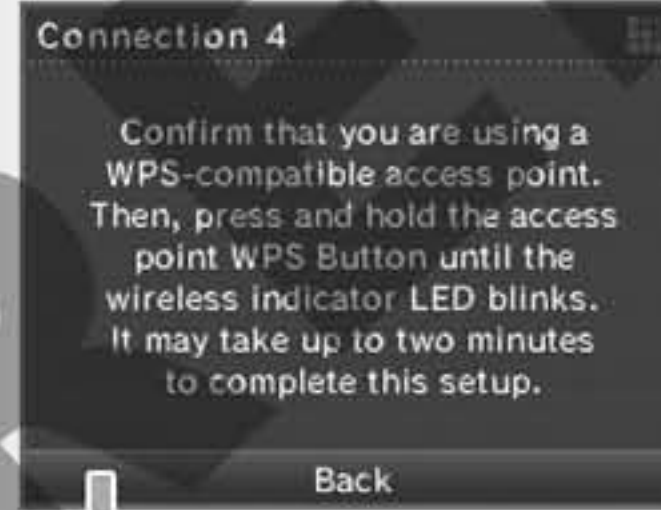

Pin connection
Set the PIN number displayed on the Nintendo DSi XL system's Touch Screen in your access point.



It may take as long as 2 minutes until setup completes.

7 Touch NEXT.



8 Touch OK to perform a connection test.



If the connection test is successful, setup is complete

Immediately after completing setup using WPS, the connection may fail due to the access point restarting. Wait a short time, then try performing a connection test again.

Options

Confirm system information, delete the Nintendo WFC Configuration and transfer the Nintendo WFC Configuration.

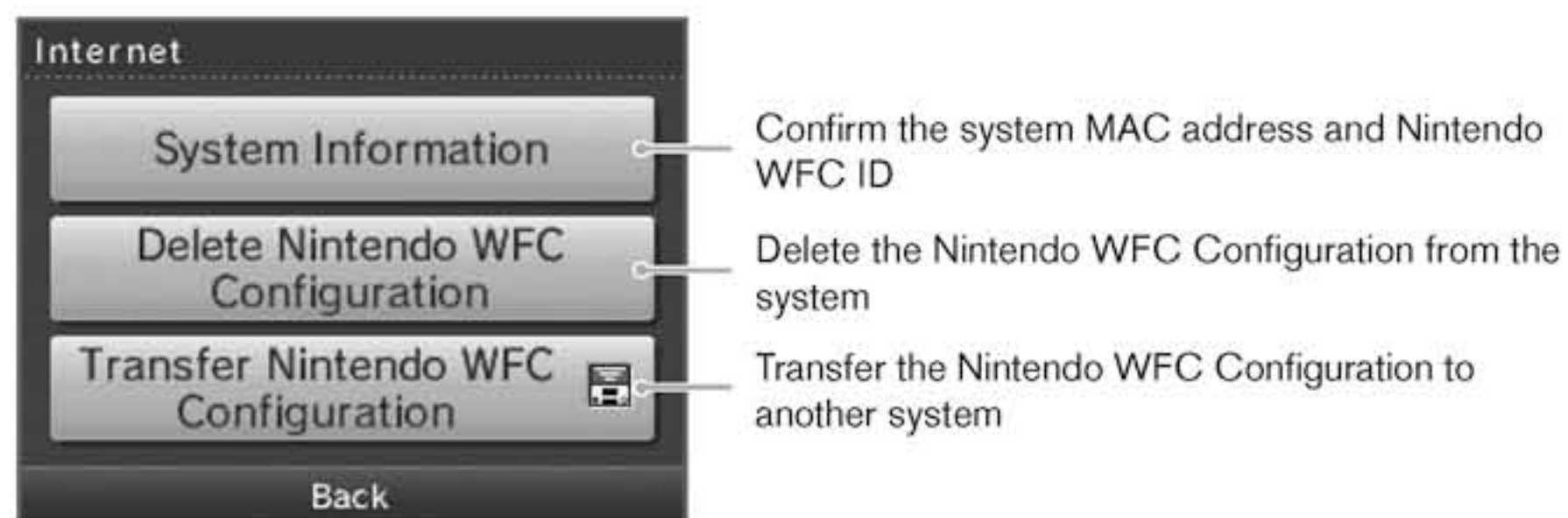

Warnings

- Please delete the Nintendo WFC Configuration before disposing of or releasing your system.
- When changing to a new system, transfer the Nintendo WFC Configuration from the old system to the new system.
- When deleting or transferring the Nintendo WFC Configuration, settings such as Friend Rosters and connections will be deleted from the source system.

Transferring Nintendo WFC Configuration to another system

Nintendo WFC Configuration transfers use DS Download Play.

Note: This deletes Nintendo WFC Configuration from the source system and overwrites the Nintendo WFC Configuration of the target system. When transferring to a Nintendo DS / DS Lite system, content of the Internet Advanced Setup information is not transferred.

Things to prepare

- Source Nintendo DSi XL system
- Target system (Nintendo DSi/Nintendo DSi XL system or Nintendo DS/DS Lite system)

How to transfer

1 Source system

Touch TRANSFER NINTENDO WFC CONFIGURATION.
↓
Follow the on-screen instructions.



2 Target system

Touch DS DOWNLOAD PLAY.
↓
Follow the on-screen instructions.

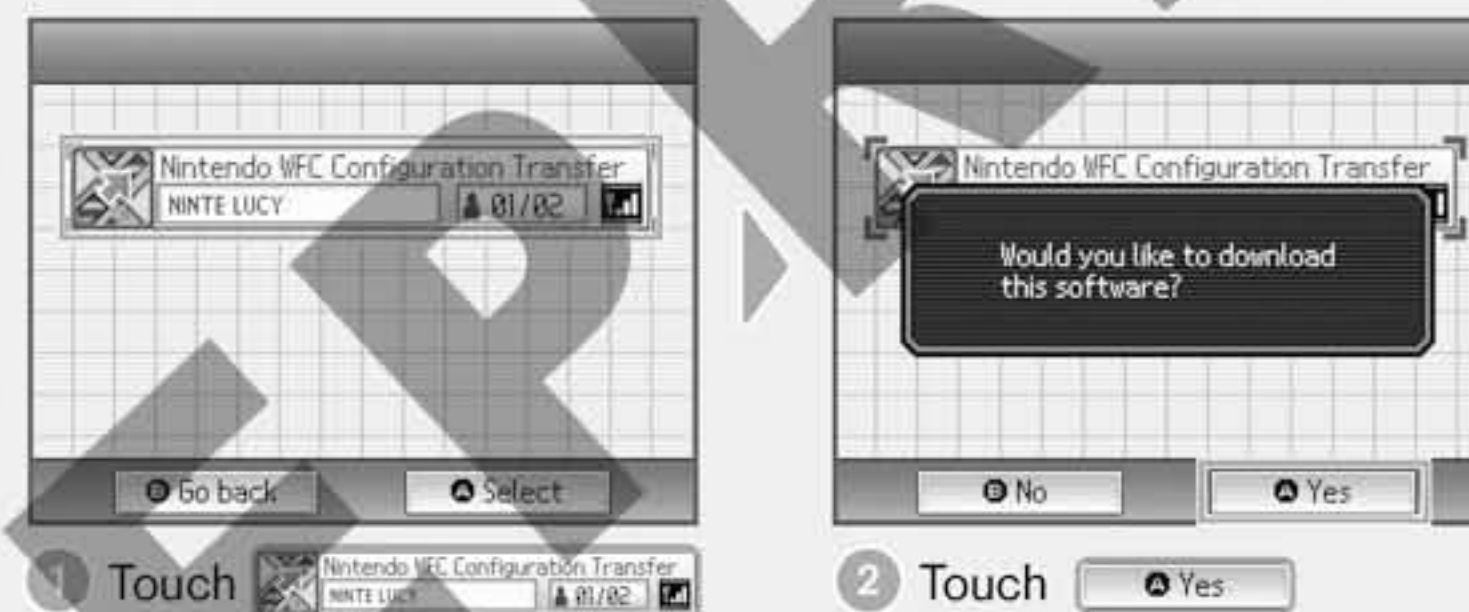

3 Source system

Confirm that the user name displayed is indeed that of the target system and touch YES.



4 Target system

Touch OK if you agree to the on-screen warning.
Note: If you touch NO, the transfer of the Nintendo WFC Configuration will be aborted.



5 Source / Target system

When the transfer is complete, a confirmation message is displayed. Touch OK on both systems.

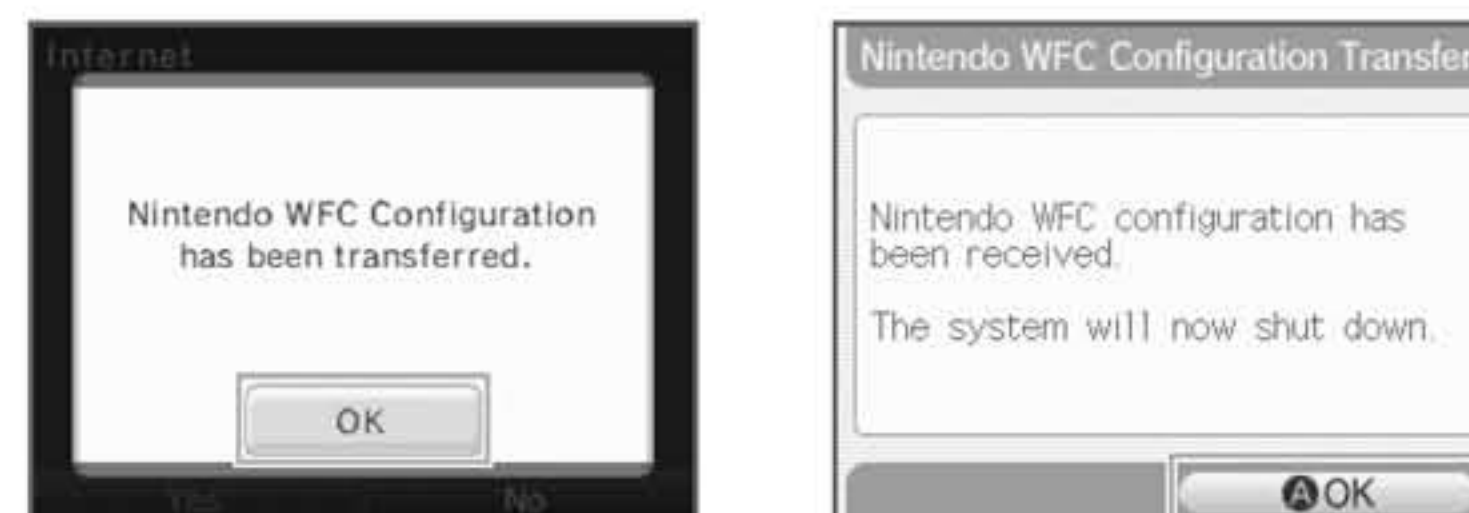

System Update

There will be updates or additions to the **Nintendo DSi Menu** or applications. Updates will take place by connecting to the internet, so please complete your internet connection settings ahead of time. [Page 82](#) →

How to Update

- 1 Touch YES.

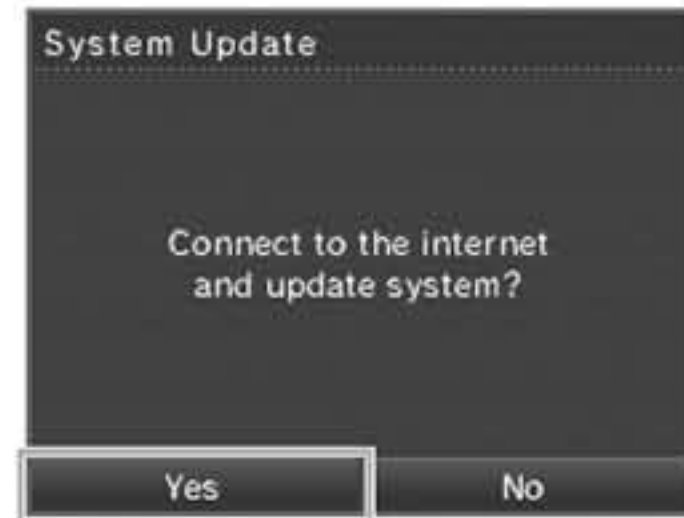

- 2 Read the on-screen text carefully and select NEXT.

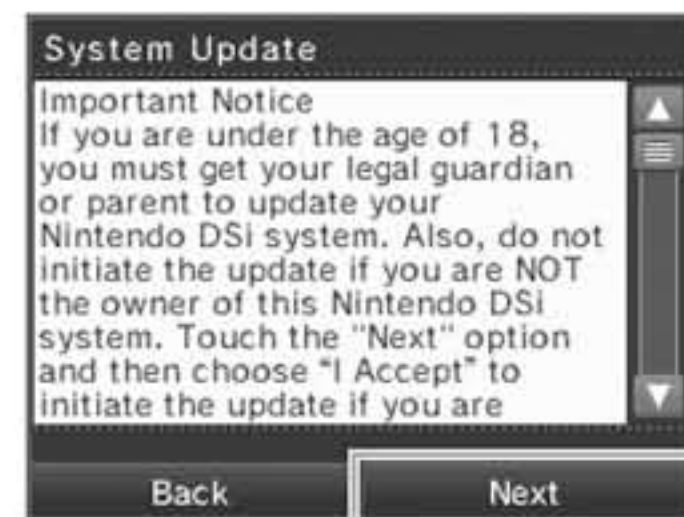

- 3 If you agree with what you read in 2 select I ACCEPT, and then touch OK.



Format System Memory

Choose this to erase all save data, and return the system to the state in which it was purchased.

- 1 Select FORMAT.

What data will be erased?

- Applications added by Nintendo DSi software.
- Software purchased via Nintendo DSi Shop.

Note: Software purchased via Nintendo DSi Shop can be downloaded again free of charge. However, if the software is no longer available for purchase via Nintendo DSi Shop, you will not be able to re-download it.

- Data saved on the System Memory.
- Changes made to the System Settings.

Note: Data erased by formatting the system cannot be restored.



Using the Keyboards

Keyboards will be displayed on the Touch Screen when you are required to enter characters. There are two types of keyboard: a standard alphanumeric keyboard and a ten-key numeric keyboard.

Alphanumeric Keyboard

Character type selection keys

- Displays the input keyboard for letters of the alphabet and numbers.
- Displays the input keyboard for special characters.
- Japanese hiragana, katakana
- Displays the input keyboard for symbols.
- Displays the input keyboard for pictures



Numeric Keyboard

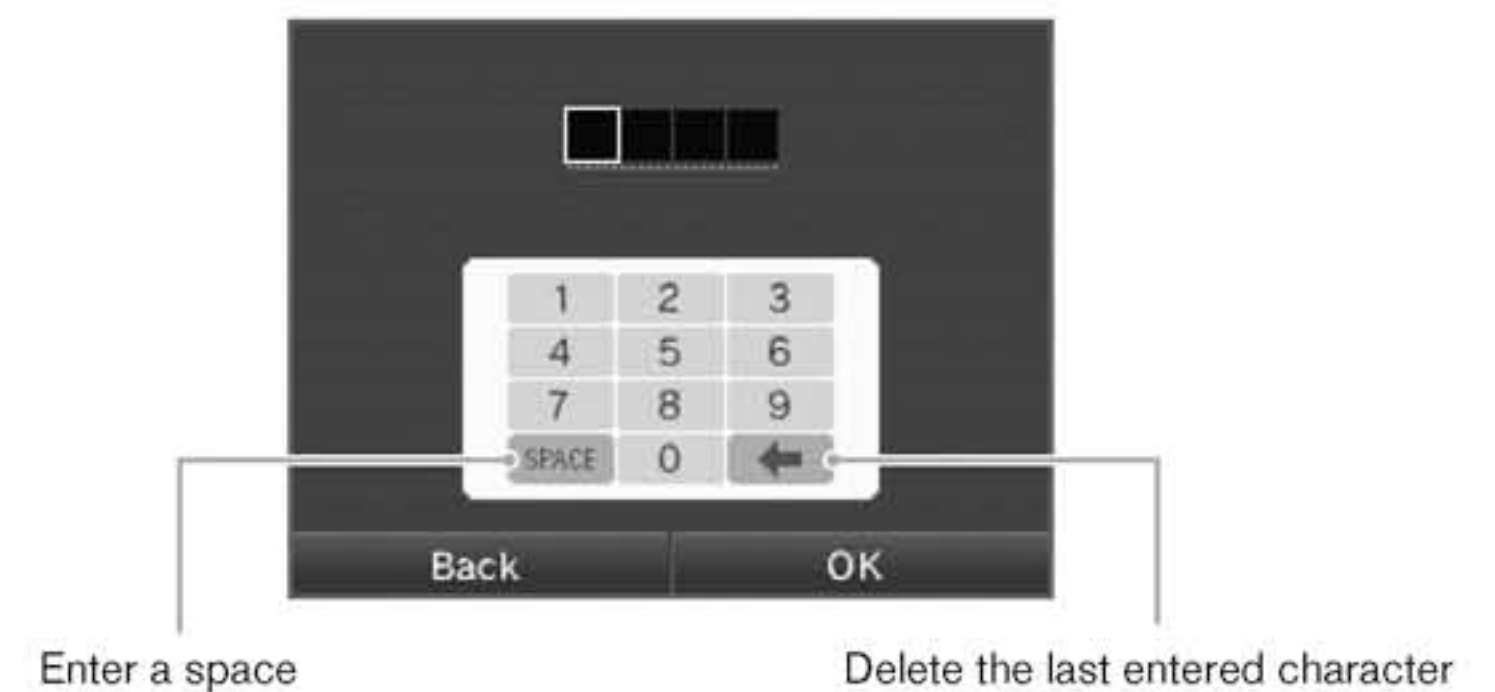

Glossary

Term	Definition
SSID	The name assigned to an access point. Also known as the ESS-ID or network name.
Key	The key is a numerical value used to encrypt the communications between the Nintendo DSi XL system and the access point. The same value must be set on the access point and the Nintendo DSi XL system. It is also known as an encryption key or a network password.
IP address	The number used to specify the destination and transmission source of communications data on the network.
Subnet mask	The numerical value indicating which part of the IP address is the number identifying the network it belongs to.
Gateway	The exit or entrance to the network in question. Its IP address is specified in the connection point settings.
Primary DNS/ Secondary DNS	The server that matches the names of computers on the network to their IP addresses. The IP address of this server is specified in the connection point settings.
DHCP server	The server that specifies the IP address and other information required for communications on the network.
MAC address	The unique number assigned to each device on the network. Your Nintendo DSi XL system has its own MAC address.
NAT	A function which a network device, such as a router, uses to convert the IP address settings so that a Nintendo DSi XL system in a LAN can connect to the internet. A connection error may occur when trying to connect to the internet using the NAT feature, depending on the network environment that you are using.
MTU	The maximum value of data that can be sent in one transmission on this network.
WEP	A method for encrypting the data sent between the Nintendo DSi XL system and the access point.
WPA-PSK(TKIP)/ WPA2-PSK(TKIP)	A method for encrypting the data sent between the Nintendo DSi XL system and the access point. This encryption method is stronger than WEP.
WPA-PSK(AES)/ WPA2-PSK(AES)	A method for encrypting the data sent between the Nintendo DSi XL system and the access point. This encryption method is stronger than WEP and TKIP.

Term	Definition
WPS	Short for Wi-Fi Protected Setup. This is a standard for easily executing wireless LAN device connection and security settings.
Proxy	A server that allows users to make an indirect connection to the internet by receiving the information requested by the user first before relaying it to the user's machine.
Nintendo Wi-Fi Connection ID	The unique number allocated to each user that connects to and plays on Nintendo Wi-Fi Connection. This is set automatically the first time the user connects to Nintendo Wi-Fi Connection.
Nintendo Wi-Fi Connection Configuration	Information containing details about connection settings and Nintendo Wi-Fi Connection ID.

Term	Definition
Entering a key for wireless security	<ul style="list-style-type: none"> On the connection settings details screen the key will be displayed as a string of asterisks (*). The key can be input using either ASCII characters or hexadecimal code consisting of the numbers 0 to 9 and the letters "a" to "f". Encryption systems which use a key are the only ones supported by the Nintendo DSi XL system. If the access point uses some other encryption system, the encryption system used on the access point will need to be changed. For information on configuring the access point settings, refer to the instruction manual provided with your access point.

Term	Definition
Entering a WEP key	<ul style="list-style-type: none"> Normally, up to four WEP keys can be registered for an access point. In the Nintendo DSi XL system's connection point settings, the WEP key in the first of the four slots should be entered, and the access point settings should also be configured to use the same WEP key. The number of characters to be used for the WEP is as follows: ASCII: either 5, or 13, or 16 characters Hexadecimal: either 10, or 26, or 32 characters

Term	Definition
Entering a WPA key	<ul style="list-style-type: none"> The number of characters to be used for a WPA key is as follows: ASCII: between 8 and 63 characters Hexadecimal: 64 characters

Error Messages and Error Codes

Please refer to the Support and Troubleshooting section of the Nintendo DSi XL Operations Manual for information about error messages and codes that are displayed. [Page 112 →](#)





Support and Troubleshooting

If you experience problems with your Nintendo DSi XL system, or an error message or error code is displayed on the screen, use this section of the manual to determine the cause of the problem.

Contents

• Troubleshooting	104
No video or audio output	104
Nintendo DSi Menu	105
I can't use the microphone	
Charging the Battery Pak	106
I can't use the Touch Screen	107
SD Memory Cards	
Nintendo DSi Camera	
Nintendo DSi Sound	108
Nintendo DSi Shop	109
I can't use DS Download Play	
I can't use PictoChat	
I'm having difficulty using DS Wireless Communications	110
The system enters Sleep Mode	
Parental Controls	111
• Error Message List	112
• Error Code List	113
• Disposal of this product at the end of its life	116
• Specifications	117

Before seeking assistance, check the following information.

Note: In addition to this section of the manual, please read the Instruction Booklet for each piece of software and peripheral device you use.

No video or audio output

- **Is the power indicator LED lit?**

Press the POWER Button to turn the power on.

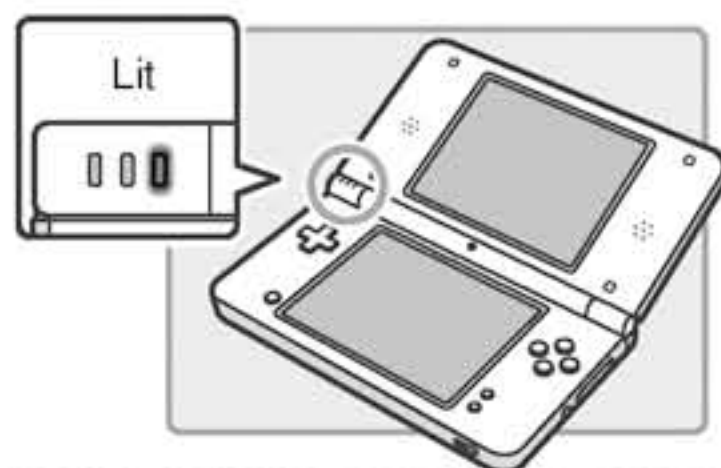

- **Has the Battery Pak been charged?**

Recharge the Battery Pak.

- **Has the Game Card been correctly inserted?**

Insert the Game Card gently but firmly until it clicks into place.

- **Is the system in Sleep Mode?**

The power indicator LED will pulse slowly when the system is in **Sleep Mode**. Check the power indicator LED. Exit **Sleep Mode** by opening the Nintendo DSi XL system.

No sound from the system speakers

- **Is the volume set to the lowest level?**

Try adjusting the volume by using the volume / brightness control on the side of the system.

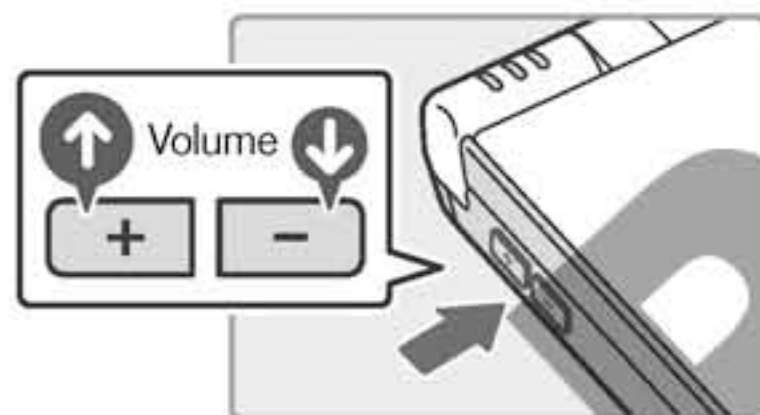

- **Are headphones, an external microphone or a headset connected?**

If headphones, an external microphone or a headset are attached to the Nintendo DSi XL, no sound will come through the speakers.

No audio from headphones or headset

- **Is the volume set to the lowest level?**

Try adjusting the volume by using the volume / brightness control on the side of the system.

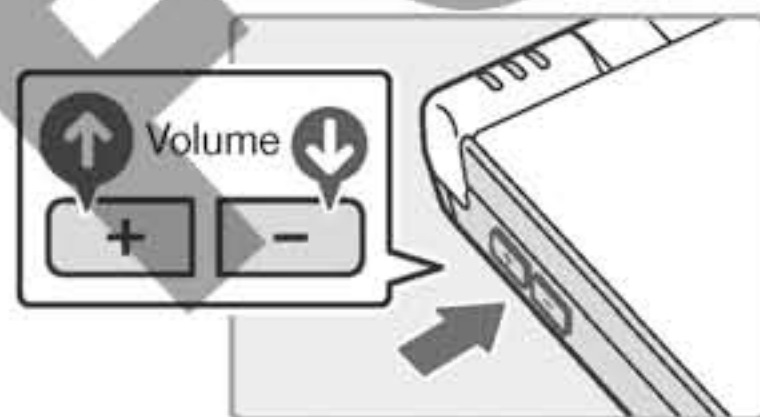

- **Is the plug of the headphones or headset firmly inserted?**

Make sure the plug of the headphones or headset is securely plugged into the audio jack.



It takes a long time before the Nintendo DSi Menu is displayed

- **Has a high-capacity SD Memory Card (SDHC Card) been inserted in the system?**
It may take time to display the Nintendo DSi Menu if a high-capacity SD Card has been inserted into the system.

Even though a Game Card has been inserted, the Nintendo DSi Menu displays THERE IS NO CARD INSERTED IN THE DS GAME CARD SLOT

- **Is the Game Card inserted properly?**

Remove the Game Card and properly reinsert it until it clicks into place. If this doesn't work, try reinserting it a few more times.

I can't play my game

- **Are Parental Controls set to restrict the use of software based on PEGI age ratings?**

Enter the PIN and either disable Parental Controls temporarily or disable the Parental Controls item that restricts the use of software based on PEGI age ratings. [Page 111](#) →

I can't use the microphone / My voice is not recognised

- **Does this software use the microphone? Does this section of the software make use of the microphone?**

The microphone cannot always be used. The microphone can only be used in parts of the software that support it.

- **Is the microphone functioning properly?**

Use MIC TEST in System Settings to confirm that the microphone is functioning properly.

[Page 81](#) →

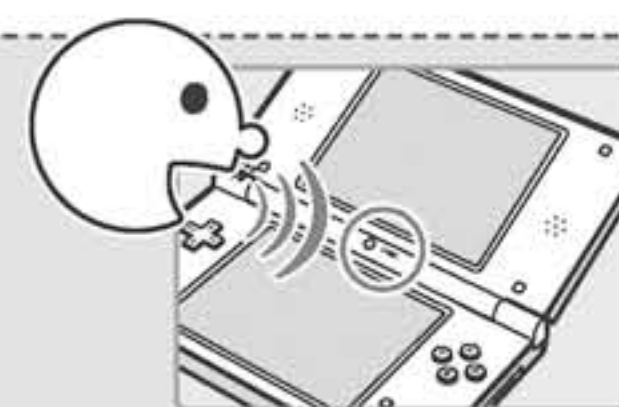

- **Are voices other than your own, such as those of family and friends, recognised correctly?**

There are individual differences in speech recognition rates. Some voices are more difficult to recognise than others.

The microphone reacts unexpectedly

The microphone may be reacting to audio output from the speaker, or ambient noise. Try to move away from the source of the noise, reduce the speaker volume, use headphones or try to prevent any background noises. Please use the MIC TEST in System Settings to determine whether the microphone is reacting.

I can't recharge the Nintendo DSi XL Rechargeable Battery Pak / The recharge indicator LED is not lit

- **Are you using a Nintendo DSi Power Supply?**
Use the Nintendo DSi Power Supply (WAP-002(UKV)).

- **Is the Nintendo DSi Power Supply firmly inserted into the system and an electrical socket?**

Make sure the Nintendo DSi Power Supply is securely connected to both the Nintendo DSi XL system and the wall socket.

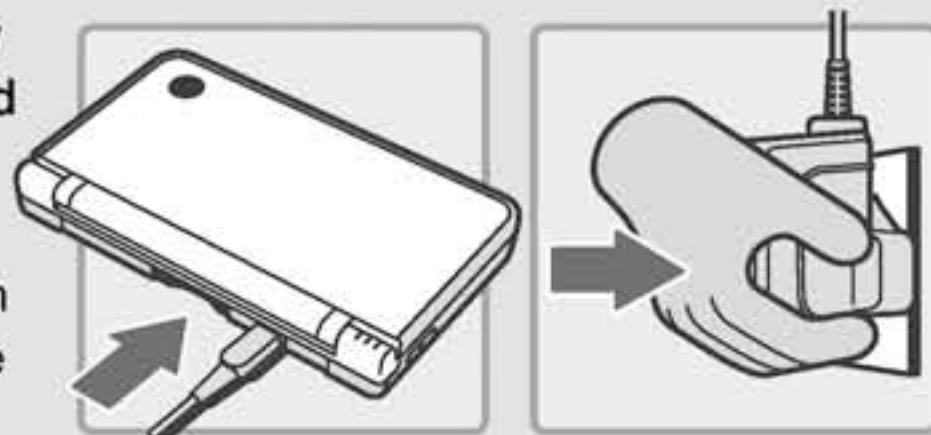

- **Is the Battery Pak being charged in a location with an ambient temperature between 5 and 35 degrees Celsius?**

Charge the Battery Pak in a location with an ambient temperature between 5 and 35 degrees Celsius. You may not be able to recharge the Battery Pak in a location outside of this temperature range.

- **Is the recharge indicator LED lit?**

If the recharge indicator LED is blinking, there is a chance that the Battery Pak is not connected properly. Make sure that the Battery Pak is connected properly.

Page 20 →

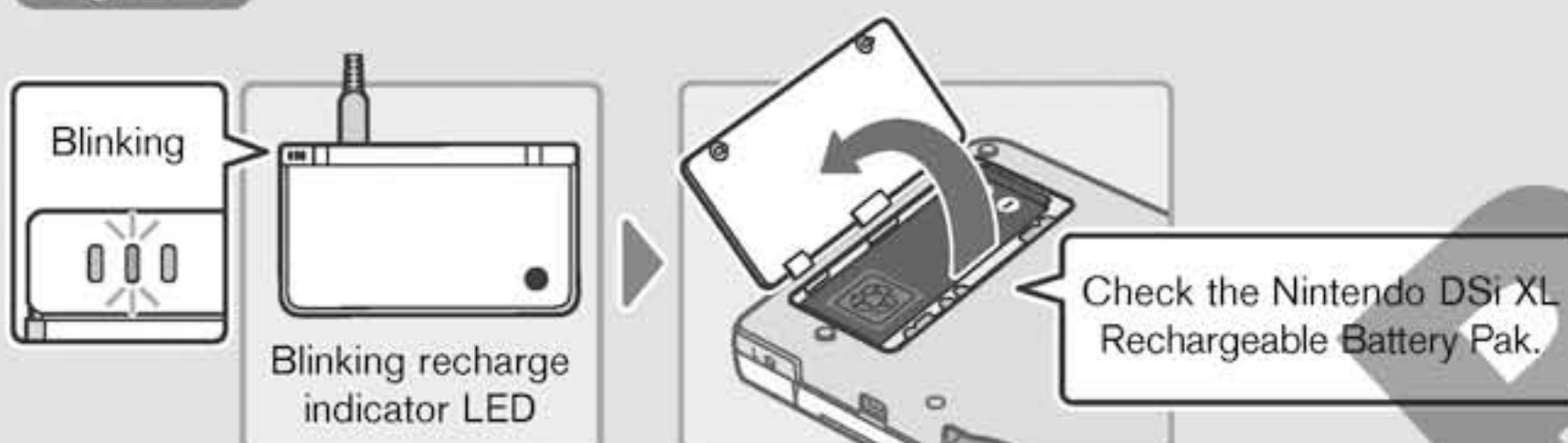

I charged the Nintendo DSi XL Rechargeable Battery Pak, but I can't play for long periods of time / It takes a long time to charge the Nintendo DSi XL Rechargeable Battery Pak

- **Are you playing a game or recharging the Battery Pak in a location with an ambient temperature less than 5 degrees Celsius?**

In environments with a temperature less than 5 degrees Celsius, you will not be able to play games for long periods of time, and the Battery Pak will take longer than usual to recharge.

I can't use the Touch Screen / The Touch Screen does not respond properly

- **Has the alignment of the Touch Screen shifted?**

If positions are no longer aligned properly, use the TOUCH SCREEN option in System Settings to correct them. [Page 81 →](#)

Note: You can start the system on the Touch Screen Calibration Screen by pressing the POWER Button while pressing and holding L Button + R Button + START.



- **Have you attached a commercially-available protective sheet to the Touch Screen?**

If you have applied a commercially-available protective sheet to the Touch Screen, refer to its instruction manual and be sure it has been applied correctly before attempting to calibrate the Touch Screen.

My SD Card is not responding

- **Has the SD Card been correctly inserted into the system?**

Insert the SD Card gently but firmly until it clicks into place in the SD Card slot on the side of the system.

- **Is the SD Card broken?**

Use a computer or digital camera to confirm that you can correctly see files on the SD Card.

- **Are there photos on the SD Card that can be displayed using Nintendo DSi Camera?**

Nintendo DSi Camera can only display photos taken on the Nintendo DSi / Nintendo DSi XL system. Photos taken on a digital camera or mobile phone will not be displayed.



- **Are there files on the SD Card that can be played back using Nintendo DSi Sound?**

Nintendo DSi Sound can play AAC files with a file extension of .m4a, .mp4 and .3gp. Non-AAC audio files (such as MP3 files) cannot be played back.

Nintendo DSi Camera repeatedly asks for a photo of my face, but does not respond

This occurs when your face cannot be properly recognised. Move to a well-lit area and turn your face in a direction that allows it to be clearly displayed on-screen. Please also take note of the following factors which may also affect face recognition.

- The ambient brightness and lighting
- Haircut (when hair covers the face, for instance)
- Hair and eyebrow colour
- Sheen on the face and head
- The shape, colour and thickness of any facial hair
- Glasses, jewellery and piercings on the face and head



My eyes and mouth are not being recognised correctly by Nintendo DSi Camera

Individual differences and the surrounding environment may prevent face recognition from working properly. If the position of your eyes and mouth are not recognised correctly, move to a well-lit area and turn your face in a direction that allows it to be captured well on-screen. Please also take note of the aforementioned factors.

Photos taken by the camera have strange colours

Make sure that you are using only the Normal lens (other lenses can cause strange colours to appear in your photos) and try to take a picture of something else. If the colours are still strange, contact the Nintendo Service Centre. [Page 119 →](#)

I can't exchange photos or frames with Nintendo DSi Camera

- **Do Parental Controls restrict the wireless transmission of photo data?**
Enter your PIN and either disable Parental Controls temporarily, or disable the Parental Controls item that restricts the wireless transmission of photo data.

[Page 111 →](#)

Nintendo DSi Sound does not display audio files and folders

- **Has the SD Card been correctly inserted into the system?**
Insert the SD Card gently but firmly until it clicks into place in the SD Card slot on the side of the system.
- **Does the SD Card contain saved audio files that can be played back using Nintendo DSi Sound?**
Nintendo DSi Sound can play AAC files with a file extension of .m4a, .mp4 and .3gp. Non-AAC audio files (such as MP3 files) cannot be played back.
- **Are there more than 3,000 audio files saved?**
No more than 3,000 audio files can be displayed.
- **Are there more than 1,000 folders with saved audio files?**
No more than 1,000 folders can be displayed.
- **Are there more than 100 audio files saved in a single folder?**
No more than 100 files can be displayed for a single folder. If there are folders with the same name on the SD Card, the audio files in those folders will be consolidated and displayed as a single folder. No more than 100 files can be displayed for this single consolidated folder.
- **Are audio files saved to a folder that is more than eight levels deep?**
Nintendo DSi Sound will only check for files up to eight directories deep.

I cannot play back audio files using Nintendo DSi Sound

- **Are the audio files in a format that can be played by Nintendo DSi Sound?**
Nintendo DSi Sound can play audio files which meet the following requirements:
 - File format: AAC (.m4a, .mp4 or .3gp)
 - Bit rate: 16–320 kbps
 - Sampling frequency: 32–48 kHz

I cannot download new games from the Nintendo DSi Shop

- **Do you have an insufficient Nintendo DSi Points balance?**
Use one of the following to register Nintendo DSi Points with the Nintendo DSi XL system:
 - Credit card (VISA or MasterCard)
 - Nintendo Points Card (this can be purchased from a Nintendo retailer)

Note: You can register Nintendo DSi Points using Wii Points Cards.
For details on registration: [Page 61 →](#)

- **Have Parental Controls restricted the use of Nintendo DSi Points in the Nintendo DSi Shop?**
Enter your PIN and either disable Parental Controls temporarily, or disable the Parental Controls item restricting the use of Nintendo DSi Points. [Page 111 →](#)

I can't use DS Download Play

- **Have Parental Controls restricted the use of DS Download Play?**
Enter your PIN and either disable Parental Controls temporarily, or disable the Parental Controls item restricting the use of DS Download Play. [Page 111 →](#)

I can't use PictoChat

- **Are there already 16 people in the selected chat room?**
No more than 16 people can enter a single chat room.
- **Have Parental Controls restricted the use of PictoChat?**
Enter your PIN and either disable Parental Controls temporarily, or disable the Parental Controls item restricting the use of PictoChat. [Page 111 →](#)

I'm having difficulty using DS Wireless Communications (Communications are interrupted and the game cannot be played smoothly)

- **Is one of the following Reception Strength icons shown on-screen?**
Reception strength appears to be poor. Move closer to the other player, and remove obstructions between you and that person.



My system suddenly enters Sleep Mode

It may have entered **Sleep Mode** as the result of an external magnetic field.

Move your system away from magnetic objects, including other Nintendo DS systems.



I cannot disable Parental Controls

- **Did you enter the correct PIN?**

Enter the correct PIN.

If you have forgotten your PIN: [Page 80 →](#)

- **Did you enter the correct answer to your secret question?**

Enter the correct answer to your secret question.

If you have also forgotten the answer to your secret question: [Page 80 →](#)

If your Nintendo DSi XL still does not operate correctly after trying these troubleshooting steps, DO NOT return the product to the retailer. You will lose saved game data and all Nintendo DSi Shop downloads and Nintendo DSi Point balances. Please call the Nintendo Service Center for assistance and additional troubleshooting and repair options.

[Page 119 →](#)

How to Disable Parental Controls

There are two ways to disable Parental Controls. You can either temporarily disable them, or change the Parental Controls settings.

Temporarily Disabling Parental Controls

- 1 Enter your PIN at the screen that is displayed when you select the restricted item.
- 2 Touch OK.



Changing the Parental Controls Setting

- 1 Go to the **System Settings Menu** and select

[Parental Controls](#).



- 2 Touch [Yes](#).



- 3 Enter your PIN.

- 4 Touch [OK](#).



- 5 Touch [Change Settings](#).



Next, follow the on-screen instructions to change restricted content.

Note: If you forget your PIN, please refer to the Parental Controls section. [Page 80 →](#)

Error Message List

If an error occurs, the following messages may appear on-screen. Follow the directions shown in the table to solve the problem.

Note: For the purposes of these error messages, "Nintendo DSi Operations Manual" refers to both the Nintendo DSi Operations Manual and the Nintendo DSi XL Operations Manual.

Error Message	Solution
An error has occurred. Press and hold the POWER Button to turn the system off. Please refer to the Nintendo DSi Operations Manual for details.	Turn the power off for a moment, then turn it back on. If you experience the same problem and the message appears again, turn the power off, and contact the Nintendo Service Centre. Page 119 →
The System Memory is damaged. Please refer to the Nintendo DSi Operations Manual for details.	The System Memory is damaged. Please contact the Nintendo Service Centre. Page 119 →
The device inserted in the SD Card slot can't be used.	An SD Card that cannot be used with the Nintendo DSi XL system or something other than an SD Card is inserted in the SD Card slot, or the system region of the SD Card is corrupted. Please insert a functional SD Card that is compatible with the Nintendo DSi XL system.
There is not enough space on this SD Card.	Either erase unnecessary software on the SD Card from the Data Management Screen under System Settings Page 72 → or erase unnecessary photos or frames from Nintendo DSi Camera. Page 32 → Otherwise, use an SD Card that contains some available space.
There are no empty slots on the system.	There are no slots available in the Nintendo DSi Menu . Erase unnecessary software from the Data Management Screen under System Settings. Page 72 →

If an error message other than those shown above is displayed, please contact the Nintendo Service Centre. **Page 119 →**

Error Code List

Error codes will be displayed along with an error message if the internet settings weren't configured correctly or if the connection test failed. Check the solutions shown in the table below, the system's internet setting [Page 82 →](#), the Nintendo website, and the instruction manual for the network devices you're using.

Note: If you are using the Nintendo Wi-Fi USB Connector and cannot connect due to error codes 052003, 052103 or 052203, the error might be caused by the security software or firewall on your computer. For details, see the Nintendo website.

Error Codes	Problem	Solution
020100 – 020999	Could not connect to Nintendo Wi-Fi Connection.	
034301 – 034304	Cannot connect to the system update server.	Wait for a while and try connecting again. If the issue persists, contact the Nintendo Service Centre. Page 119 →
034300 034305 – 034499	The system could not be updated due to an internet error.	
050100 – 050199	Unable to connect to the internet.	
023000 – 025999	The Nintendo Wi-Fi Connection servers are either undergoing maintenance or are very busy.	Wait for a while and try connecting again. If the issues persists, check the Nintendo website to see if the server is undergoing maintenance.
034000 – 034218 034500 – 034699	An error occurred, so the system could not be updated.	Please contact the Nintendo Service Centre. Page 119 →
034219 034220	Insufficient free blocks in the System Memory.	Erase unnecessary software from the Data Management Screen under System Settings. Page 72 →
050000 – 050099	No access point in range.	<ul style="list-style-type: none"> • Check the access point settings. The wireless signals may be too weak at your location. • Try moving closer to your access point, and make sure there are no people, objects or other obstacles between the system and the access point. • Make sure the access point is in a usable state. For details, see the instruction manual for your access point.
050500 – 050599	You must accept the terms of use.	Agree to the terms of use. Page 82 →
050600 – 050699	Wireless Communications is currently disabled under System Settings.	Enable the Wireless Communications setting. Page 73 →
051000 – 051099	Could not find an access point with the SSID that has been set.	Check whether the SSID in the connection settings matches the settings for the access point you want to connect to.

Error Code List

Error Codes	Problem	Solution
051100–051199	Could not connect to the access point.	<ul style="list-style-type: none"> • Make sure the security key in the connection settings matches that of the access point. • If you are using a Nintendo Wi-Fi USB Connector, configure your computer to allow connections. If this error code occurs even after connections are allowed, the wireless signals may be too weak at your location. • Try moving closer to your access point, and make sure there are no people, objects or other obstacles between the system and the access point.
051200–051299	Could not connect because the maximum number of simultaneous connections to the access point has been exceeded.	The access point you tried to connect has a limit on the number of devices that can connect to it. Wait for a while and try again.
051300–051399	Cannot connect to the access point for an unknown reason.	<ul style="list-style-type: none"> • See the solutions for error codes 051100–051299. • Reconfigure the access point settings.
052000–052099	Could not automatically acquire the IP address.	<ul style="list-style-type: none"> • Enable the DHCP server feature of your access point or other network device. If you cannot use the DHCP server feature, you will have to configure the IP address and other such settings manually. Page 92 → • Make sure the security type and key of the connection settings match the settings for the access point you want to connect to.
052100–052399 312004 312005	Could not connect to the internet.	<ul style="list-style-type: none"> • Confirm that your network environment can connect to the internet. • Review the settings under AUTO-OBTAIN IP ADDRESS in the connection settings. • If the AUTO-OBTAIN IP ADDRESS setting is set to NO, check whether the security type and key in the connection settings match the settings for the access point you want to connect to.
052400–052599 312012 312013	Could not connect to the proxy server.	<ul style="list-style-type: none"> • Confirm that your network environment can connect to the proxy server. • Review the proxy server settings.
052700–052799	Cannot connect because there is another network device that is set to the same IP address.	Review the AUTO-OBTAIN IP ADDRESS setting in the connection settings.

Error Codes	Problem	Solution
053000–053299	Could not connect to the internet.	<ul style="list-style-type: none"> • The wireless signals may be too weak at your location. Try moving closer to your access point, and make sure there are no people, objects or other obstacles between the system and the access point.
054000–054199 290500–290599 291000–291099	Communication error. You have been disconnected from the network.	<ul style="list-style-type: none"> • The wireless signals may be too weak at your location. Try moving closer to your access point, and make sure there are no people, objects or other obstacles between the system and the access point. • This might be a temporary issue, so wait a while and then try again. If the issue persists, contact the Nintendo Service Centre. Page 119 →

If an error message other than those shown above is displayed, please contact the Nintendo Service Centre. **Page 119 →**

Disposal of this product at the end of its life

At the end of this product's life, please do not dispose of this product in your general household waste. Instead, please dispose of this product separately in accordance with your local recycling laws and regulations. For more information on the separate collection systems for waste electrical and electronic equipment that are available for consumers, free of charge, near your home, please contact your local municipal authority.

As an alternative and if you plan to buy an equivalent new product, you may be able to bring this product to your local retailer who, in exchange for your buying an equivalent new product, may take back this product and arrange for its recycling. However, we would suggest that you first double-check with your local retailer whether they will offer you this service.

Either way, this product will then be treated in an environmentally sound manner at a licensed recycling plant and its components will be recovered, recycled or reused in the most efficient way possible, in compliance with the requirements of the Directive on Waste Electrical and Electronic Equipment (2002/96/EC) of 27 January 2003.

Under applicable environmental laws, you should always use the available separate collection systems for waste electrical and electronic equipment. In some countries, failure to use these systems may even result in sanctions being taken against you.

Notes:

1. Waste electrical and electronic equipment may contain hazardous substances, which, if not treated properly, can be harmful to the environment and human health. Specific treatment of waste electrical and electronic equipment is therefore indispensable.
2. All Nintendo electrical and electronic equipment that is subject to the above Directive is designed in a way which takes full account of, and facilitates, its possible repair, upgrading, reuse, dismantling and recycling.
3. Nintendo and its official distributors support recycling schemes in each European country and are committed to using the best available treatment, recovery and recycling techniques in order to ensure both human health and high environmental protection.
4. The crossed-out wheeled bin symbol (see below) is affixed to all relevant Nintendo electrical and electronic equipment that has been put onto the market by Nintendo or its official distributors on or after 13 August 2005. The symbol means that these products must be collected separately from other waste at the end of their life, in order to ensure maximum recovery and environmentally sound disposal.





Specifications

Nintendo DSi XL system

Model Number	UTL-001(EUR)
LCD Screens	Transmissive TFT Colour LCD (can display 260,000 colours)
Screen Size	4.2 inches (85.25 mm wide x 63.94 mm high)
Number of Pixels	256 x 192 pixels
Power Sources Used	Nintendo DSi Power Supply (WAP-002(UKV)) Rechargeable Battery Pak (UTL-003)
Wireless Frequency	2.4 GHz Band
Output Power	11b: 5.5 dBm / 11g: 5.0 dBm maximum
Communication Standard	IEEE 802.11 b/g (DSSS/OFDM) compliant
Recommended Communication Distance	Approx. 10–30 m Note: The maximum distance at which communication is possible may be reduced depending on the surroundings. Only use these figures as a rough estimate.
Camera Feature	Lens: Fixed focal length / Image sensor: CMOS / Effective pixels: about 300,000
Clock Feature	Max. Daily Variation of ± 4 seconds (when used within the "Usable Environment" below)
Input / Output Terminals	Game Card slot, SD Card slot, Power Supply connector, audio jack
Maximum Power Consumption	Approx. 2.8W (when charging)
Usable Environment	Temperature: 5–35 degrees Celsius / Humidity: 20–80 %
Dimensions	91.4 mm high x 161.0 mm wide x 21.2 mm thick (when closed)
Mass	Approx. 314 g (including Battery Pak and stylus)
Charge Time	Approx. 3 hours
Battery Life	The battery life will change depending on the brightness of the LCD screens. Page 12 →

Nintendo DSi XL Rechargeable Battery Pak

Model Number	UTL-003
Battery Type	Lithium Ion
Battery Capacity	3.9 Wh

Nintendo DSi Power Supply

Model Number	WAP-002(UKV)
Input / Output	AC 230V 50Hz / DC 4.6V 900mA
Dimensions / Weight	70.5 mm long x 51.0 mm wide x 79.5 mm thick / Approx. 86 g
Cord Length	Approx. 1.9 m
Compatible Hardware	Nintendo DSi XL (UTL-001(EUR)) Nintendo DSi (TWL-001(EUR))

Nintendo DSi XL stylus / Nintendo DSi XL stylus (large)

Model Number	UTL-004 / UTL-005
Material	Plastic parts (stylus body (ABS) / stylus tip (PE))
Dimensions / Weight	Approx. 96.0 mm / Approx. 1.8 g Approx. 129.3 mm / Approx. 9.1 g

Note: In the course of making improvements, changes to any of these specifications may be made without notice.

**12 MONTHS WARRANTY – applicable to the NINTENDO DSi
and the NINTENDO DSi XL HARDWARE**
(hereinafter referred to as "Nintendo DSi system")

CONSUMER WARRANTY

This warranty covers the Nintendo DSi system and the original built-in software included with the Nintendo DSi system at the time of purchase (the "Nintendo DSi Operating Software"). (In this warranty, the Nintendo DSi system and the Nintendo DSi Operating Software are together referred to as the "Product").

Subject to the terms and exclusions below, Nintendo warrants to the original consumer purchasing the Product ("you") that, for a period of 12 months from the date of the purchase of the Product by you, the Product will be free from defects in materials and workmanship.

To make a valid claim under this warranty, you must notify Nintendo of the defect in the Product within 12 months of the date of the purchase of the Product by you and you must return the Product to Nintendo within 30 days of notifying Nintendo of that defect. If, having inspected the Product, Nintendo accepts that the Product is defective, Nintendo will (at its sole discretion) either repair or replace the part causing the defect or replace the Product without charge.

This warranty does not affect your statutory rights.

EXCLUSIONS

This warranty does not cover:

- software (other than the Nintendo DSi Operating Software) or games (whether or not included with the Product at the time of purchase);
- accessories, peripherals or other items that are intended for use with the Product but are not manufactured by or for Nintendo (whether or not included with the Product at the time of purchase);
- the Product if it was purchased outside the European Economic Area;
- the Product if it has been resold, or used for rental or commercial purposes;
- defects in the Product that are caused by accidental damage, your and/or any third party's negligence, unreasonable use, use with products not supplied or licensed by Nintendo (including, but not limited to, non-licensed game enhancements, copier devices, adapters, power supplies or non-licensed accessories), computer viruses or connecting to the internet, use of the Product otherwise than in accordance with the Nintendo DSi Operations Manual or any other instructions provided with the Product, or any other cause unrelated to defects in material and workmanship;
- gradual decrease over time in the capacity and performance of the Nintendo DSi Rechargeable Battery Pak (TWL-003) or Nintendo DSi XL Rechargeable Battery Pak (UTL-003) (which, to avoid any doubt, will not be deemed to be a defect in material or workmanship of the Product).
- the Product if it has been opened, modified or repaired by any person other than Nintendo or it has its serial number altered, defaced or removed; or
- loss of any data loaded or stored on the Product by any person other than Nintendo.

HOW TO MAKE A CLAIM

To notify Nintendo of a defect covered by this warranty, please contact:

Nintendo Service Centre
Codestorm House, Walton Road, Farlington, Hampshire PO6 1TR, Tel: +44 (0) 870 60 60 247

(calls are charged at National Rates for UK customers and International Rates for Irish customers - please obtain permission from the person responsible for the bill before calling).

Before sending the Product to the Nintendo Service Centre, you should remove or delete any private or confidential files or data. You accept and agree that Nintendo will not be responsible for any loss, deletion or corruption of your files or data that have not been deleted or removed. Nintendo strongly recommends that you make a back up copy of any data that you do not remove or delete.

When sending the Product to the Nintendo Service Centre, please:

1. use the original packaging where possible;
2. provide a description of the defect;
3. attach a copy of your proof of purchase, ensuring that it contains the date of purchase of the Product; and
4. ensure that it is received by Nintendo within 30 days of the original notification of a qualifying defect.

If the above 12 months warranty period has expired at the time the defect is discovered or if the defect is not covered by this warranty, Nintendo may still be prepared to repair or replace the part causing the defect or replace the Product (at its sole discretion). For further information about this and, in particular, the details of any charges for such services, please contact:

Nintendo Service Centre
Tel: +44 (0) 870 60 60 247

(calls are charged at National Rates for UK customers and International Rates for Irish customers - please obtain permission from the person responsible for the bill before calling).

NINTENDO DSi OPERATING SOFTWARE

The Nintendo DSi Operating Software may only be used with the Product and may not be used for any other purpose. You must not copy, adapt, reverse engineer, decompile, disassemble or modify the Nintendo DSi Operating Software other than as expressly permitted by applicable law. Nintendo may use anti-copying or other measures to protect its rights in the Nintendo DSi Operating Software.



HOTLINE

Call our games hotline for assistance on all Nintendo published/distributed software, hardware and accessories. Our dedicated games counsellors can answer all your gameplay questions offering hints, tips and strategies to ensure that you get the most from your Nintendo products.

To call the hotline, dial*

+44 (0) 870 60 60 247

(* Calls from a landline within the UK are charged at the standard national rate offered by the caller's network provider. Charges may vary for calls made using a mobile phone.

Customers calling from outside the UK will be charged at the international rate offered by the provider of the network being used to make the international call.

Please obtain permission from the person responsible for paying the bill before calling.)

Lines are open Monday to Friday from 08:30 to 19:00, and Saturday from 08:30 to 15:30**.

(** Charges and opening hours are correct at time of printing – November 2008 – but are subject to change without prior notice.)

TM, ® and Nintendo DSi are trademarks of Nintendo.

© 2010 Nintendo. All rights reserved.

This product includes RSA BSAFE Cryptographic software from RSA Security Inc.

RSA is a registered trademark of RSA Security Inc.

BSAFE is a registered trademark of RSA Security Inc. in the United States and/or other countries.

© 2005 RSA Security Inc. All Rights Reserved.

SDHC logo is a trademark.

This product uses certain fonts provided by Fontworks Inc.

This product uses the LC Font by Sharp Corporation.

LCFONT, LC Font and the LC logo mark are trademarks of Sharp Corporation.

This product includes a face recognition software FSE (Face Sensing Engine) provided by OKI.

This product includes speech rate conversion software developed by Toshiba corporation.

Copyright © 2008 TOSHIBA CORPORATION

Ubiquitous TCP/IP+SSL Copyright © 2001–2008 Ubiquitous Corp.

Powered by Devicescape Software. Portions of this products are © 2003–2008 Devicescape Software, Inc. All rights reserved.

Copyright © 2003–2008, Jouni Malinen <j@w1.fi> and contributors. All Rights Reserved.

WPA Supplicant licensed pursuant to BSD License.

THIS SOFTWARE IS PROVIDED BY THE COPYRIGHT HOLDERS AND CONTRIBUTORS "AS IS" AND ANY EXPRESS OR IMPLIED WARRANTIES, INCLUDING, BUT NOT LIMITED TO, THE IMPLIED WARRANTIES OF MERCHANTABILITY AND FITNESS FOR A PARTICULAR PURPOSE ARE DISCLAIMED. IN NO EVENT SHALL THE COPYRIGHT OWNER OR CONTRIBUTORS BE LIABLE FOR ANY DIRECT, INDIRECT, INCIDENTAL, SPECIAL, EXEMPLARY, OR CONSEQUENTIAL DAMAGES (INCLUDING, BUT NOT LIMITED TO, PROCUREMENT OF SUBSTITUTE GOODS OR SERVICES; LOSS OF USE, DATA, OR PROFITS; OR BUSINESS INTERRUPTION) HOWEVER CAUSED AND ON ANY THEORY OF LIABILITY, WHETHER IN CONTRACT, STRICT LIABILITY, OR TORT (INCLUDING NEGLIGENCE OR OTHERWISE) ARISING IN ANY WAY OUT OF THE USE OF THIS SOFTWARE, EVEN IF ADVISED OF THE POSSIBILITY OF SUCH DAMAGE.

This product includes software developed by the OpenSSL Project for use in the OpenSSL Toolkit. (<http://www.openssl.org/>).

Copyright © 1998–2007 The OpenSSL Project. All rights reserved.

THIS SOFTWARE IS PROVIDED BY THE OpenSSL PROJECT "AS IS" AND ANY EXPRESS OR IMPLIED WARRANTIES, INCLUDING, BUT NOT LIMITED TO, THE IMPLIED WARRANTIES OF MERCHANTABILITY AND FITNESS FOR A PARTICULAR PURPOSE ARE DISCLAIMED. IN NO EVENT SHALL THE OpenSSL PROJECT OR ITS CONTRIBUTORS BE LIABLE FOR ANY DIRECT, INDIRECT, INCIDENTAL, SPECIAL, EXEMPLARY, OR CONSEQUENTIAL DAMAGES (INCLUDING, BUT NOT LIMITED TO, PROCUREMENT OF SUBSTITUTE GOODS OR SERVICES; LOSS OF USE, DATA, OR PROFITS; OR BUSINESS INTERRUPTION) HOWEVER CAUSED AND ON ANY THEORY OF LIABILITY, WHETHER IN CONTRACT, STRICT LIABILITY, OR TORT (INCLUDING NEGLIGENCE OR OTHERWISE) ARISING IN ANY WAY OUT OF THE USE OF THIS SOFTWARE, EVEN IF ADVISED OF THE POSSIBILITY OF SUCH DAMAGE.

This product includes cryptographic software written by Eric Young.

Copyright © 1995–1998 Eric Young (eay@cryptsoft.com). All rights reserved.

THIS SOFTWARE IS PROVIDED BY ERIC YOUNG "AS IS" AND ANY EXPRESS OR IMPLIED WARRANTIES, INCLUDING, BUT NOT LIMITED TO, THE IMPLIED WARRANTIES OF MERCHANTABILITY AND FITNESS FOR A PARTICULAR PURPOSE ARE DISCLAIMED. IN NO EVENT SHALL THE AUTHOR OR CONTRIBUTORS BE LIABLE FOR ANY DIRECT, INDIRECT, INCIDENTAL, SPECIAL, EXEMPLARY, OR CONSEQUENTIAL DAMAGES (INCLUDING, BUT NOT LIMITED TO, PROCUREMENT OF SUBSTITUTE GOODS OR SERVICES; LOSS OF USE, DATA, OR PROFITS; OR BUSINESS INTERRUPTION) HOWEVER CAUSED AND ON ANY THEORY OF LIABILITY, WHETHER IN CONTRACT, STRICT LIABILITY, OR TORT (INCLUDING NEGLIGENCE OR OTHERWISE) ARISING IN ANY WAY OUT OF THE USE OF THIS SOFTWARE, EVEN IF ADVISED OF THE POSSIBILITY OF SUCH DAMAGE.

Nintendo DSi XL contains browser technology ("Opera Browser") licensed from Opera Software ASA (www.opera.com).

(Opera® Browser from Opera Software ASA. Copyright 1995-2008 Opera Software ASA. All rights reserved.)

The Opera Browser includes the Zlib compression library, developed by Jean-loup Gailly and Mark Adler.

Copyright © 1995–2004 Jean-loup Gailly and Mark Adler.

Number-to-string and string-to-number conversions are covered by the following notice:

The author of this software is David M. Gay. Copyright © 1991, 2000, 2001 by Lucent Technologies.

Permission to use, copy, modify, and distribute this software for any purpose without fee is hereby granted, provided that this entire notice is included in all copies of any software which is or includes a copy or modification of this software and in all copies of the supporting documentation for such software.

THIS SOFTWARE IS BEING PROVIDED "AS IS", WITHOUT ANY EXPRESS OR IMPLIED WARRANTY. IN PARTICULAR, NEITHER THE AUTHOR NOR LUCENT MAKES ANY REPRESENTATION OR WARRANTY OF ANY KIND CONCERNING THE MERCHANTABILITY OF THIS SOFTWARE OR ITS FITNESS FOR ANY PARTICULAR PURPOSE.

This product is using Mobiclip™, a software video codec of Actimage. Mobiclip is a trademark of Mobiclip Inc. © 2008 Mobiclip Inc. All rights reserved. www.mobiclip.com



