

English	4
Deutsch	118
Français	234
Nederlands	350

NOT FOR REPRINT

*This seal is your assurance that Nintendo has reviewed this product and that it has met our standards for excellence in workmanship, reliability and entertainment value. Always look for this seal when buying games and accessories to ensure complete compatibility with your Nintendo Product.*



Thank you for selecting the Nintendo DSi™ system.

NINTENDO DS<sup>i</sup>

Basics  
section

Page 7

Applications  
and Settings  
section

Page 23

Support  
and Trouble-  
shooting  
section

Page 99

Thank you for purchasing the Nintendo DSi™ system. Please read this Operations Manual before use and follow all the instructions carefully. Additionally, be sure to read the Health and Safety Precautions Booklet. If this product is to be used by young children, this manual should be read and explained to them by an adult. Please keep this manual for future reference.

## Set Contents

- Nintendo DSi system  
(TWL-001(EUR))



- Nintendo DSi Power Supply  
(WAP-002(EUR))



- Nintendo DSi stylus  
(TWL-004) x 2

**Note:** One stylus is located in the side of the system.



- Nintendo DSi Quick-Start Guide

Read this to get a quick overview of the main features and learn how to load software.

- Nintendo DSi Operations Manual

- Basics
- Applications and Settings
- Support and Troubleshooting\*

\*Read this section if you think your product might be broken.

- Health and Safety Precautions Booklet



## Nintendo DSi Operations Manual







### Basics

The following points are explained in this section of the Nintendo DSi Operations Manual.

- Component Names and Functions
- Charging the Nintendo DSi Rechargeable Battery Pak
- Replacing the Nintendo DSi Rechargeable Battery Pak

This section should be read in conjunction with the Applications and Settings section of the Nintendo DSi Operations Manual.

## Contents

	<u>Component Names and Functions</u>	10
	<u>Charging the Nintendo DSi Rechargeable Battery Pak</u>	15
	<u>Adjusting the Volume / Screen Brightness</u>	18
	<u>Using SD Memory Cards</u>	19
	<u>Replacing the Nintendo DSi Rechargeable Battery Pak</u>	20
	<u>Using the Nintendo DSi stylus and Touch Screen</u>	22



## Component Names and Functions

Nintendo DSi system (TWL-001(EUR))

Front of the system

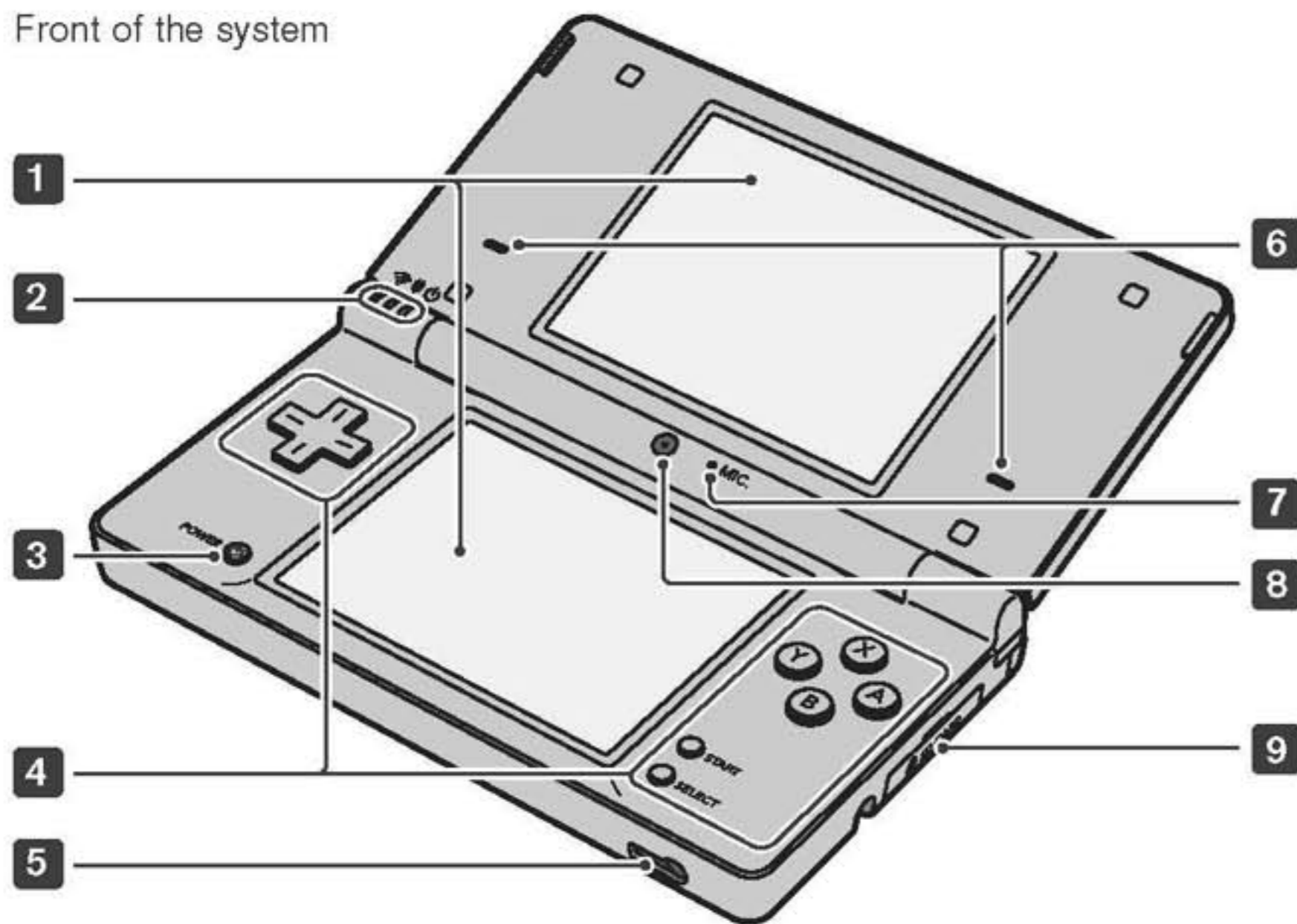

### 1 LCD screens

Twin backlit colour liquid crystal displays. The lower screen (the Touch Screen) is touch sensitive. Software which makes use of this control feature should be operated with the Nintendo DSi stylus that is included. The screen brightness can be adjusted to one of 5 levels. [Page 18 →](#)

**CAUTION:** When opening the Nintendo DSi, keep your fingers away from the hinge to avoid pinching them.

### 2 Wireless indicator LED Recharge indicator LED Power indicator LED

### 3 POWER Button

- When the power is off: Press to turn on the system.
- When the power is on: Press to reset the system and return to the **Nintendo DSi Menu Screen**. Press and hold (0.5 seconds or more) to turn off the power.

### 4 Control Buttons

The **+** Control Pad, A, B, X and Y Buttons, and START and SELECT. Used for game play control. See the Instruction Booklet for the game you are playing for specific game control information.

### 5 Audio Jack

For connection of commercially-available stereo headphones, external microphone or headset. When one of these is connected, no sound will be played through the speakers.

### 6 Speakers

### 7 Microphone (MIC.)

Used by games and software with microphone functionality.

### 8 Inner Camera

Used by games and software with camera functionality.

### 9 SD Memory Card Slot

For inserting SD Memory Cards (a.k.a. "SD Cards"), which are sold separately.

[Page 19 →](#)

## Functions of Each LED

Indicates various system statuses, depending on the colour of each LED, and whether these LEDs are solidly lit or blinking.

### Wireless Indicator LED

Lights up yellow when DS Wireless Communications are enabled for use.

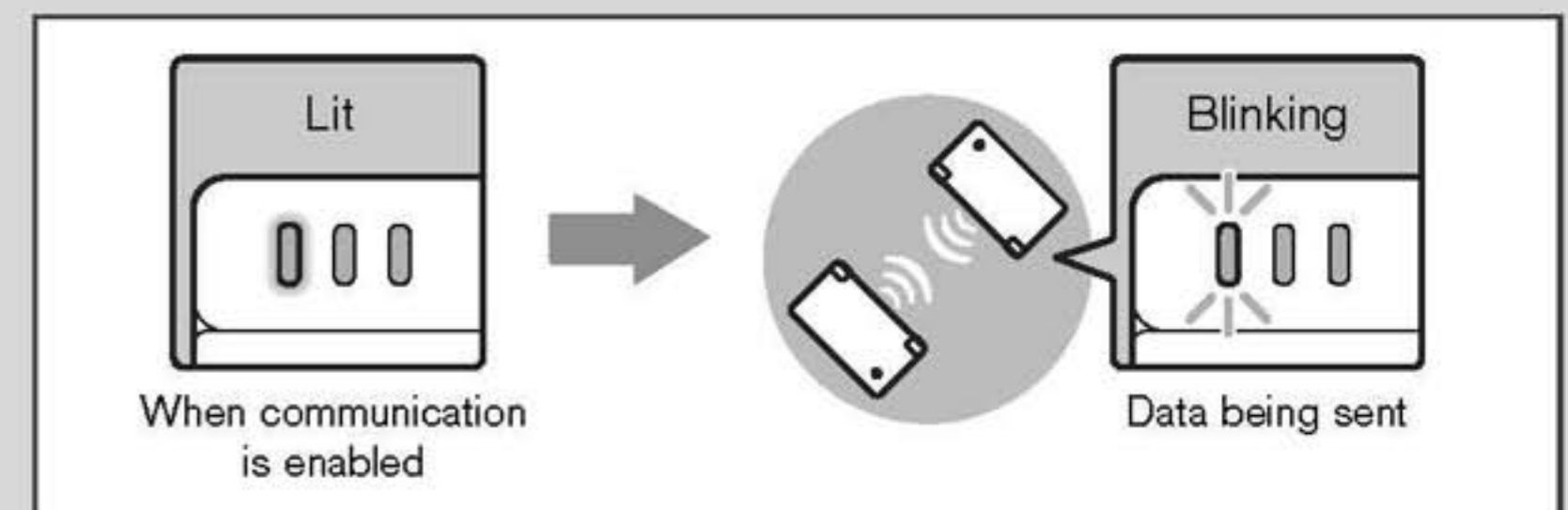

## Recharge Indicator LED

Lights up orange when the battery is being charged.

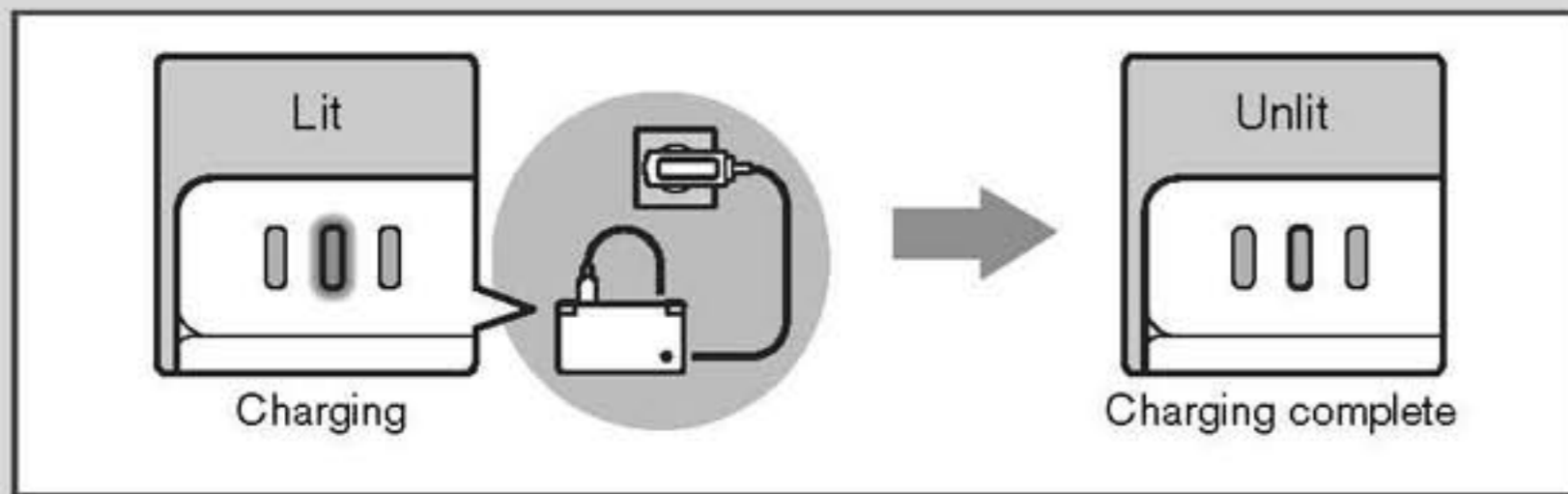

- If you play a game while the system is recharging, the recharge indicator LED may not always turn off once charging has completed. This is not a malfunction.
- If the recharge indicator LED is blinking, there is a chance that the Battery Pak has not been placed properly inside the battery compartment. Make sure it is placed correctly and connected properly. [Page 20 →](#)

## Power Indicator LED

Lights up blue when the power is turned on. Lights up red when the remaining battery charge is low, and flashes when the battery is almost completely depleted.

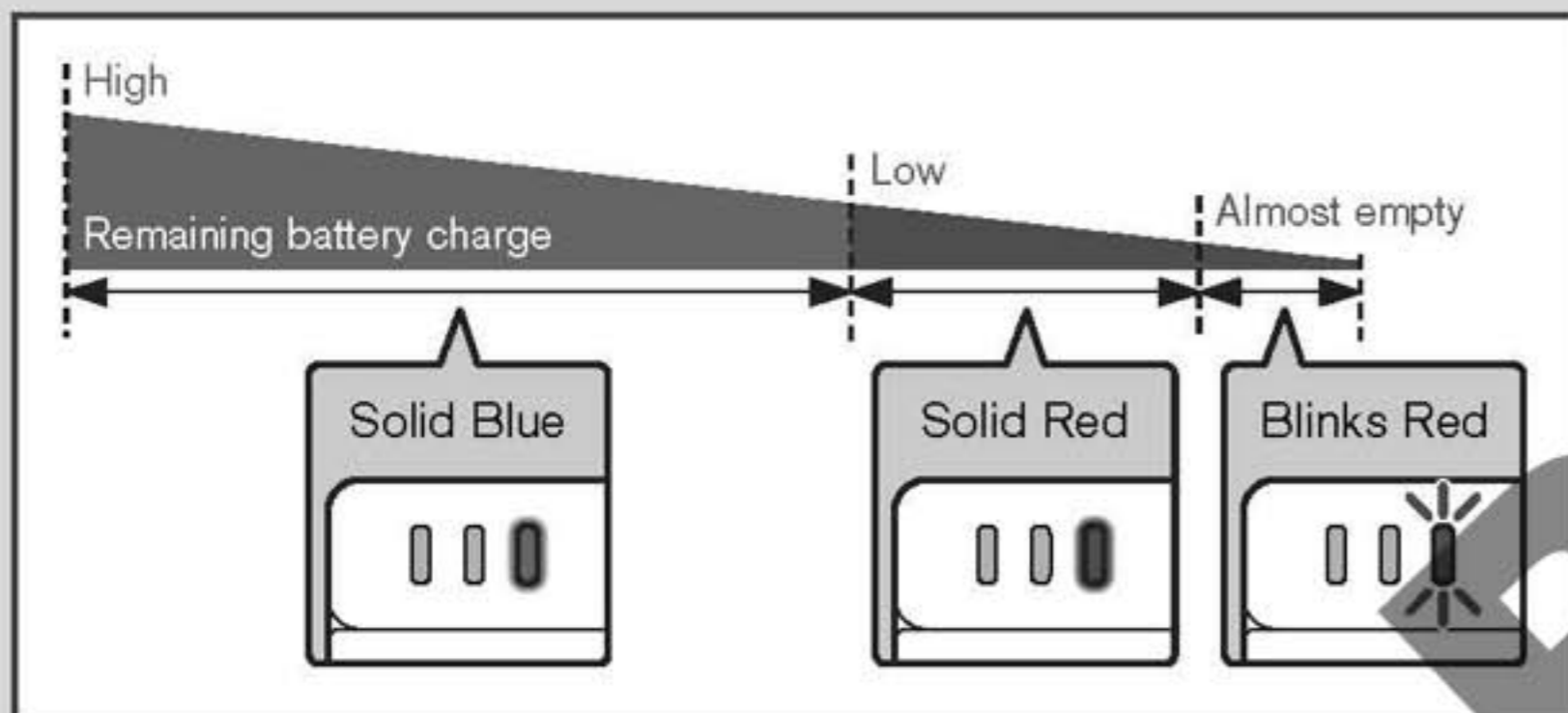

**Note:** If the power indicator LED is red, save your game quickly and recharge. If the battery charge runs out before you save, you may lose some data. If the LED slowly brightens and dims either blue or red, the battery is in **Sleep Mode**, which will conserve the battery charge.

## Nintendo DSi system (Continued)

Back of the system

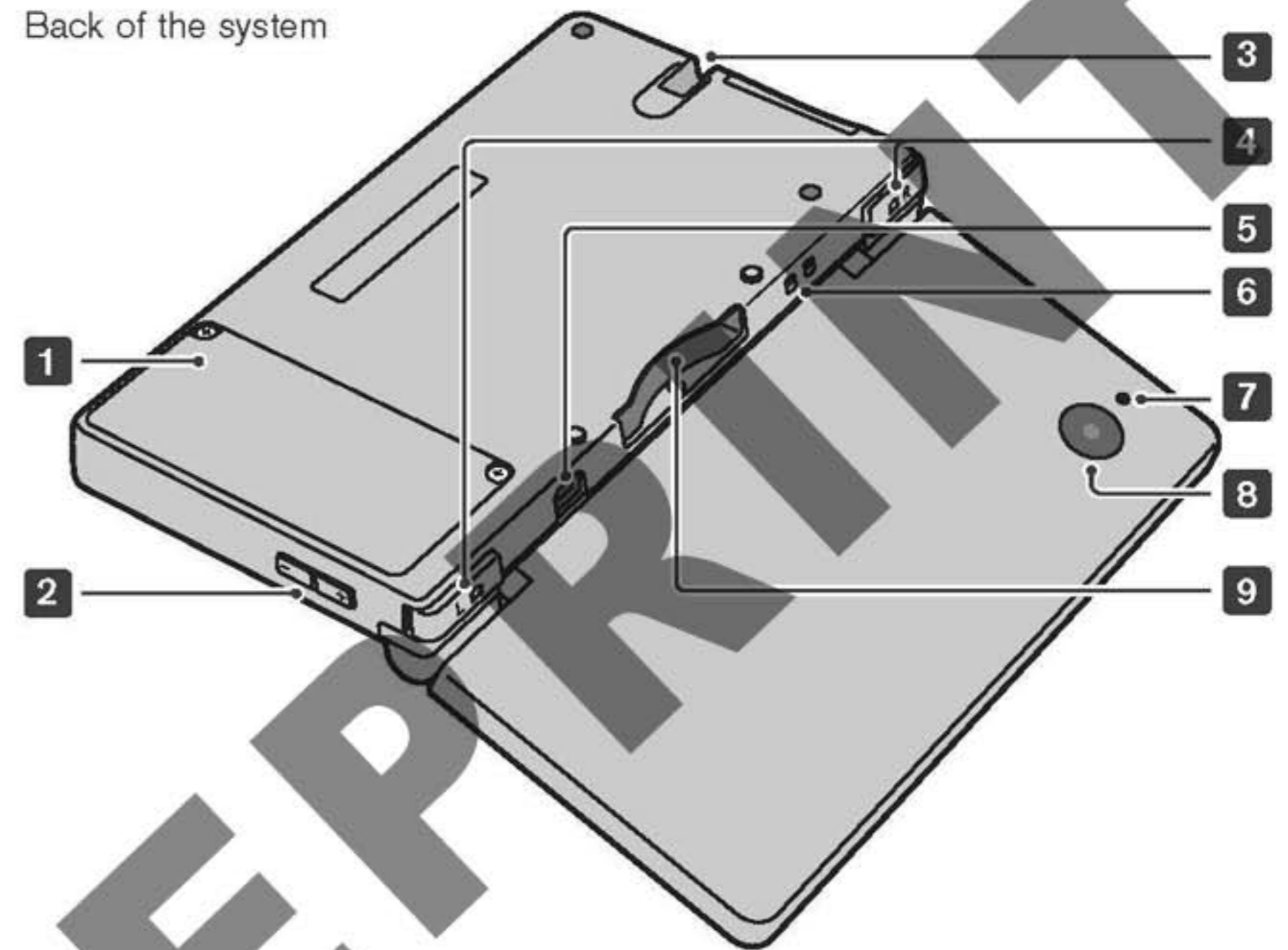

### 1 Battery Cover

Can be removed to replace the Rechargeable Battery Pak. See [Page 20 →](#) for more information on battery replacement.

### 2 Volume / Brightness Control

This adjusts the volume and brightness (in 5 levels). [Page 18 →](#)

### 3 Nintendo DSi Stylus Holder

Always place the Nintendo DSi stylus back into the stylus holder after use.

**Note:** Do not insert anything other than the official Nintendo DSi stylus into the stylus holder. Doing so could damage the system or cause a blockage in the stylus holder.

### 4 Control Buttons (L Button, R Button)

### 5 Power Supply Connector

Allows connection of the Nintendo DSi Power Supply (included) for recharging the battery or operation of the Nintendo DSi system using household mains power.

[Page 15 →](#)

### 6 Wrist Strap Attachment

For attachment of a wrist strap (sold separately).

### 7 Camera Indicator LED

This LED lights up when the outer camera is in use.

### 8 Outer Camera

### 9 Game Card Slot

For loading Nintendo DSi Cards, Nintendo DSi compatible Cards, and Nintendo DS Cards.

## Nintendo DSi Power Supply (WAP-002(EUR))

This is the Power Supply used with the Nintendo DSi.

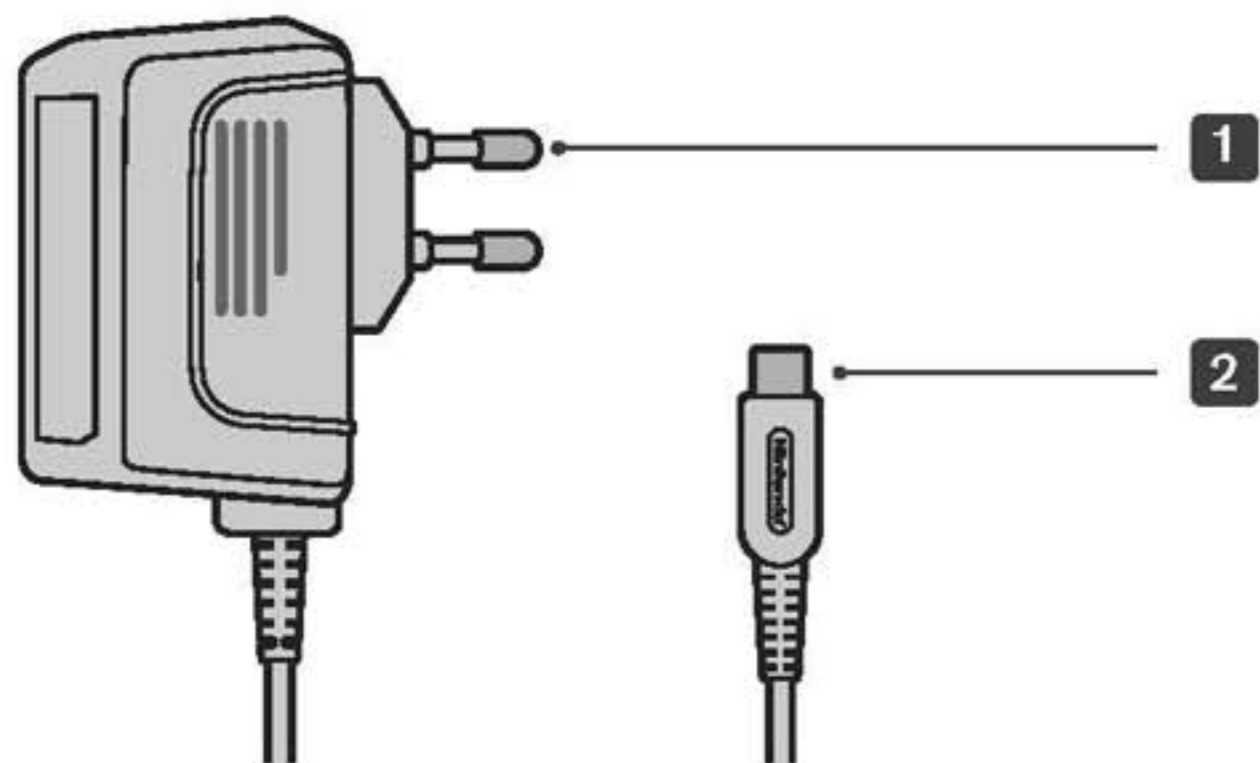

### 1 AC Plug

Plug for use in a standard 230-volt household electrical socket.

### 2 DC Plug

Connects to Power Supply connector for recharging the Battery Pak or when using household mains power.

## Nintendo DSi stylus (TWL-004)

A stylus used to control the system by directly touching the Touch Screen (lower screen).

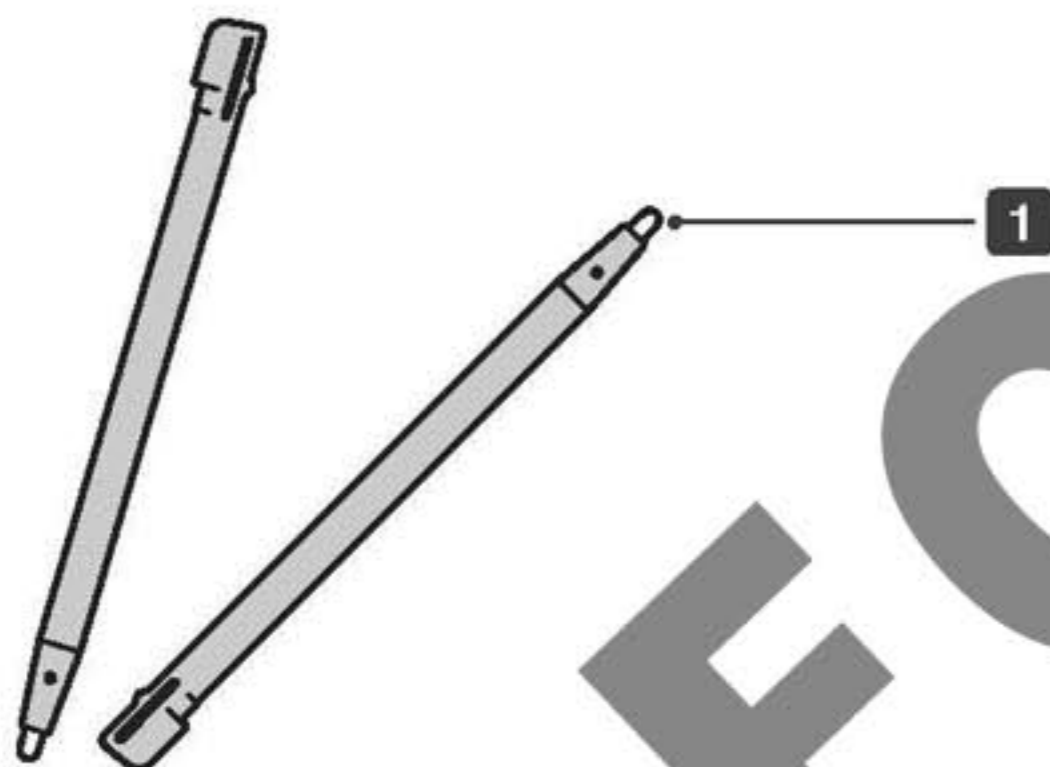

### 1 Stylus Tip

Place this end of the stylus against the Touch Screen when controlling the system.

The system comes with two styli. One is shipped in the stylus holder on the side of the system. Make sure to keep the other stylus as a backup.

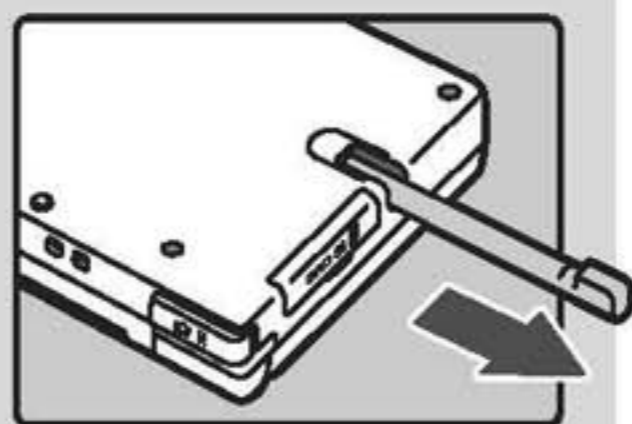

## Charging the Nintendo DSi Rechargeable Battery Pak

**CAUTION:** Do not use the Nintendo DSi Power Supply during a lightning storm, as there may be a risk of electric shock from lightning.



Before you use the Nintendo DSi for the first time, or after you have not used it for a long time, you must charge the Battery Pak. (If the Nintendo DSi is not used for long periods of time, the battery should still be recharged at least once every six months.)

When fully charged, the battery will last from 9–14 hours on the lowest screen brightness setting, depending on the type of game activity. (See [Page 18](#) → for information on adjusting the screen brightness.) On the brightest setting, the battery life is 3–4 hours.

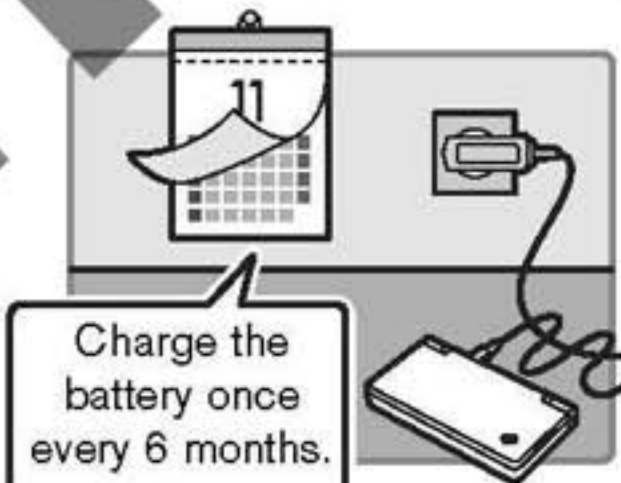

The Battery Pak can be recharged approximately 500 times, but performance may decrease after repeated recharges, depending on usage conditions such as temperature. (Optimal charging temperature is between 5 and 35 degrees Celsius.) Battery life may also decrease over time. After 500 recharges, battery life may be only 70% of the battery life at the time of purchase.

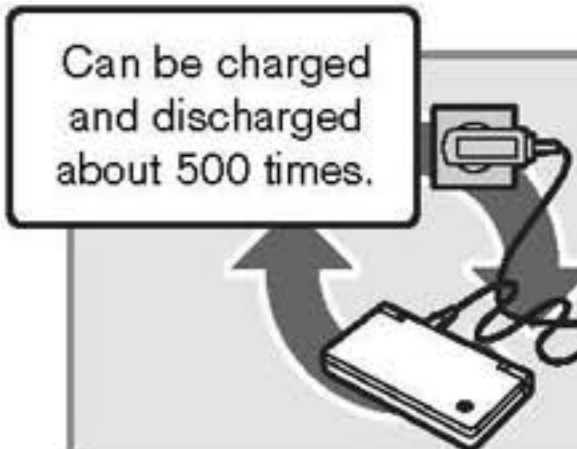

It takes approximately two and a half hours to recharge the Battery Pak. (The actual time varies depending on how much battery life you have left.) When the power indicator LED turns red, save your game and recharge the battery to prevent loss of game data. You can play games while recharging the battery, but the recharge time will be longer.



**IMPORTANT:** The Nintendo DSi Power Supply (WAP-002(EUR)) is only for use with the Nintendo DSi system. It is not compatible with any other Nintendo system.

Charge the batteries when the ambient temperature is between 5–35 degrees Celsius. Attempting to charge the Battery Pak when the ambient temperature is outside this range may degrade the Battery Pak and prevent it from charging. If the ambient temperature is low, the batteries may not charge completely.

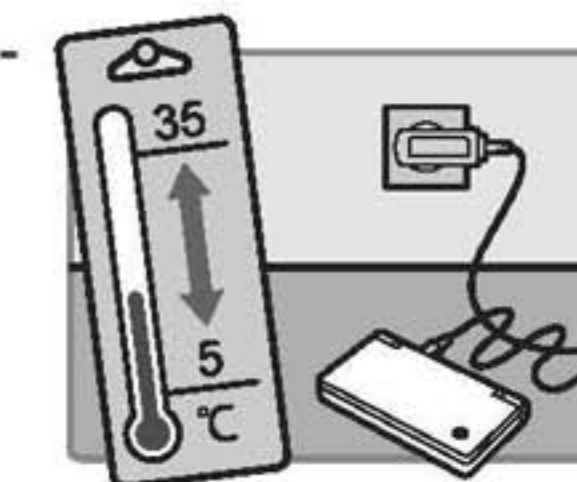

If you feel the usage time has dropped off noticeably, replace the Battery Pak. Replacement Battery Paks are sold separately. Please contact your Nintendo Service Centre for further information on where to purchase a replacement. [Page 117](#) →



## Charging the Nintendo DSi Rechargeable Battery Pak

- 1 Insert the DC plug from the Power Supply into the Power Supply connector on the back of the Nintendo DSi.

**IMPORTANT:** Be sure the DC plug is facing in the correct direction before inserting into the Power Supply connector to avoid damaging either the DC plug or Power Supply connector.

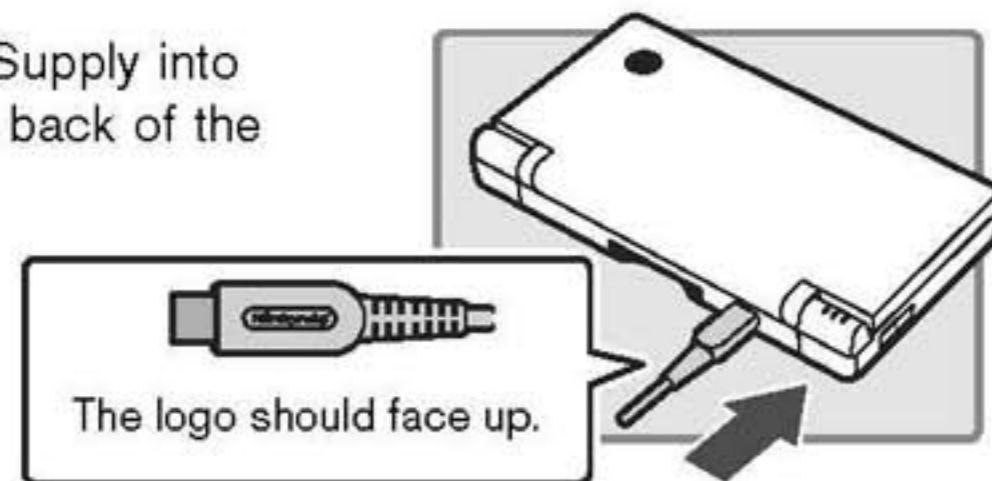

- 2 Insert the AC plug of the Power Supply into a standard 230-volt AC wall socket. Be sure that the pins are fully inserted into the socket. The recharge indicator LED will light up orange until the battery is fully charged. You can use the Nintendo DSi while recharging; however, it will take longer to recharge the battery. When you use the Nintendo DSi while recharging, the recharge indicator LED may remain on even when charging is complete. This is not a malfunction.

- If the recharge indicator LED is not lit, make sure the Power Supply is connected properly to both the system and the wall socket.
- If the recharge indicator LED is blinking, there is a chance that the Battery Pak has not been placed properly inside the battery compartment. Make sure it is placed correctly and connected properly.

Page 20 →

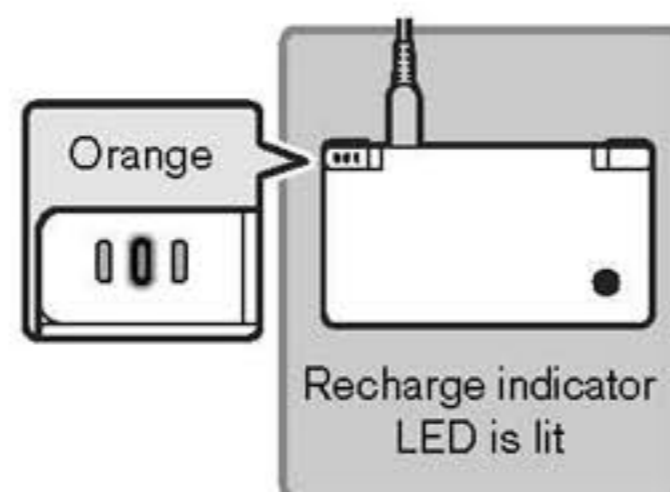
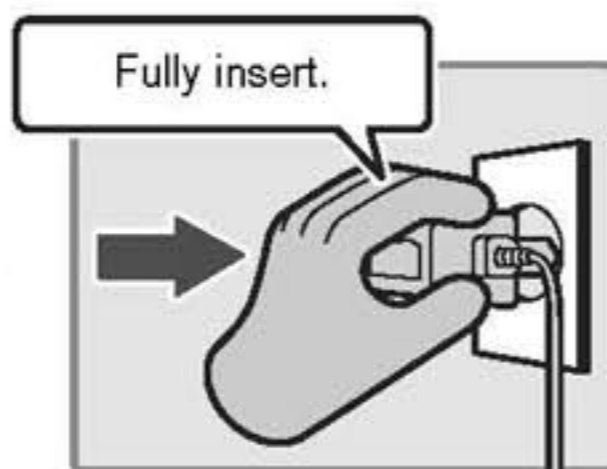

- 3 Wait until charging has completed.

- 4 When fully charged, the recharge indicator LED will turn off. Remove the Power Supply from the wall socket. Then remove the DC plug from the Power Supply connector.

**IMPORTANT:** When disconnecting any plugs from the Nintendo DSi or wall socket, carefully pull by the plug itself rather than by the cord. Do not wrap the Power Supply cord around the Nintendo DSi system.

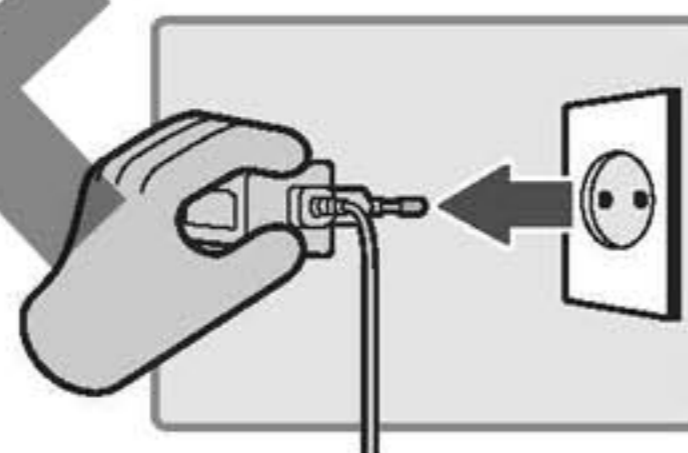
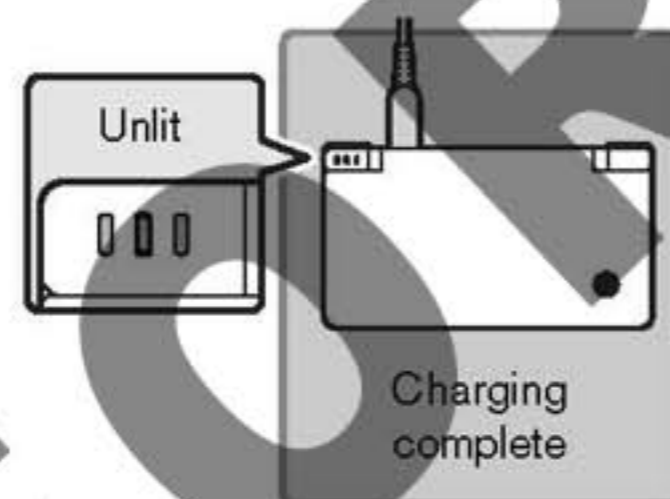

- 5 Hold the Power Supply's DC plug and unplug it from the system.

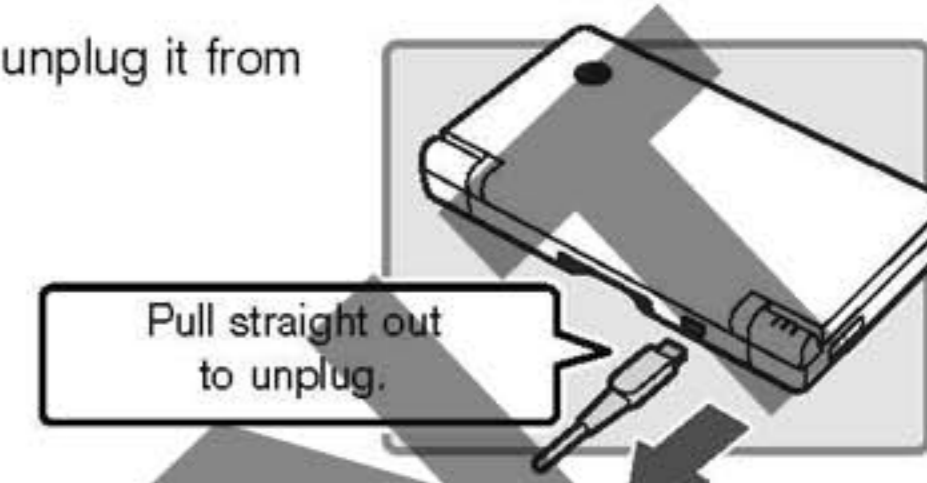

- The Nintendo DSi system must only be used with the Nintendo DSi Power Supply.
- The Power Supply conforms to Low Voltage Directive (2006/95/EC).
- The Power Supply should be regularly examined for damage to the cord, plug enclosure and other parts.
- In the event of damage the Power Supply must not be used until the damage has been repaired.
- The Nintendo DSi is not intended for children under 3 years old.
- The Power Supply is not a toy.
- The Power Supply is for indoor use only.
- If the external flexible cable or cord of the Power Supply becomes damaged, it should be replaced by the Nintendo Service Centre in order to avoid any potential hazards.
- The Nintendo DSi should be disconnected from the Power Supply before cleaning.
- Please note that the device and, in particular, the battery must be kept out of reach of very young children.
- Do not use the Power Supply in places where it may be splashed with water or any other liquids, i.e. juice, pet urine or oil, or in extremely humid places.
- Do not use travel transformers or incandescent-specific light dimmers because they may change the power voltage.





## Adjusting the Volume / Screen Brightness

### Adjusting the Volume

- 1 Press the volume / brightness control.  
Press the + side to increase the volume.  
Press the - side to decrease the volume.
  - The camera's shutter sound will always be played at a fixed volume, regardless of the current setting of the volume control.
  - When the system is in **Sleep Mode**, the volume can be decreased but not increased.

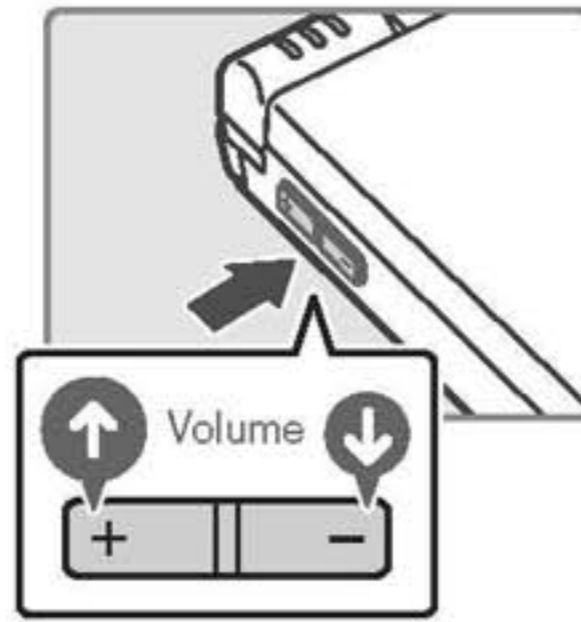

### How to start the system with low (muted) volume

Turn the power on while holding down the - side of the volume / brightness control.

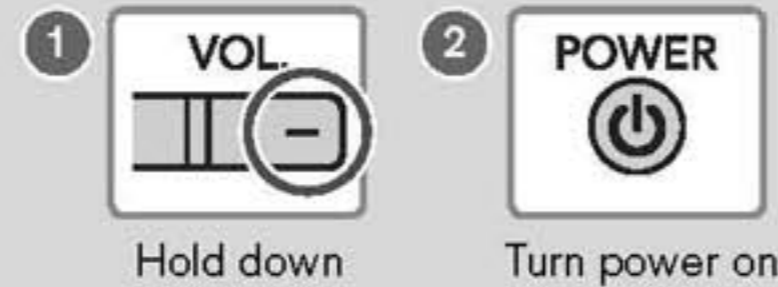

### Adjusting the Screen Brightness

- 1 While holding SELECT...
 

---
- 2 ...press the volume / brightness control.  
Press the + side to increase the brightness.  
Press the - side to decrease the brightness.
  - Changing the screen brightness will also change the brightness of the power indicator LED and the wireless indicator LED.
  - Increasing the screen brightness will increase the power consumption. The power indicator LED may change from blue to red as a result of the screen being made brighter. Note that the battery may run out and the system may lose power immediately after the power indicator LED becomes red.

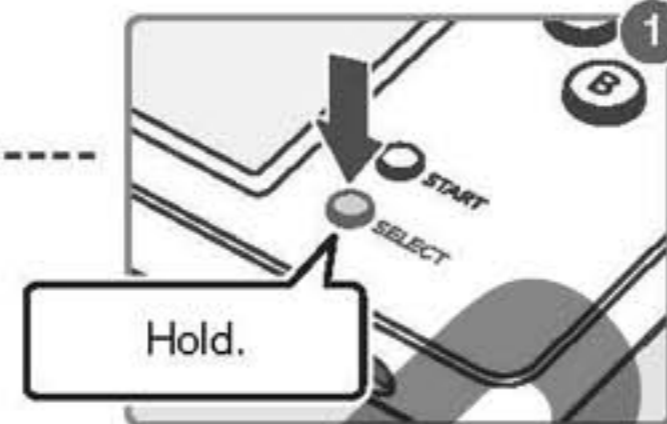

### The relationship between screen brightness and battery duration

Increasing the screen brightness will reduce battery life. Decreasing the screen brightness will increase battery life. Adjust the brightness to the level you are most comfortable with. [Page 114 →](#)



## Using SD Memory Cards

Using an SD Card (sold separately) allows you to do the following:

- Backup data for photos taken with Nintendo DSi Camera.
- Playback sound files saved in AAC-encoded format.
- Backup downloadable software and its save data.

### Note:

- It may not be possible to copy some software.
- Data copied to SD Cards cannot be used on other systems.
- Save data on Game Cards cannot be copied.

### Precautions about the use of SD Cards

- The Nintendo DSi supports high-capacity SD Cards over 2 GB in size ("SDHC Cards").
- An "SD Card adapter" is required to use miniSD or microSD Cards. When using a card adapter, be sure to remove the entire adapter (not just the card). Malfunction, or damage to the system or your data could result if the card adapter is left in the system.

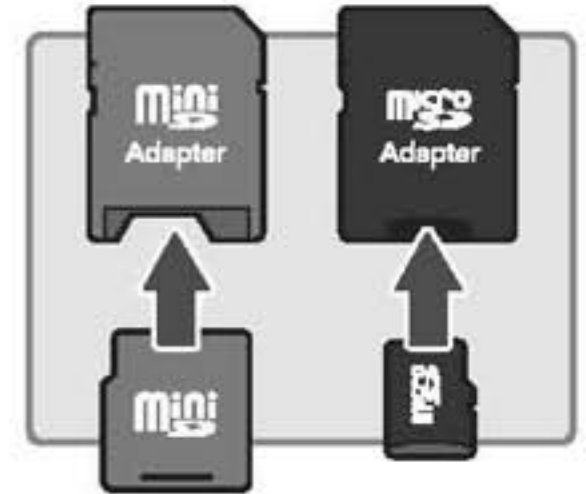

### How to Insert

- 1 Open the SD Card slot cover.  
**Note:** Do not pull or twist the slot cover forcefully. Doing so could stretch or deform it, which could cause the cover not to close.
- 2 Insert the SD Card into the SD Card slot, and push it gently but firmly until it clicks into place, then replace the slot cover.  
**Note:** The label should face towards the bottom of the system.

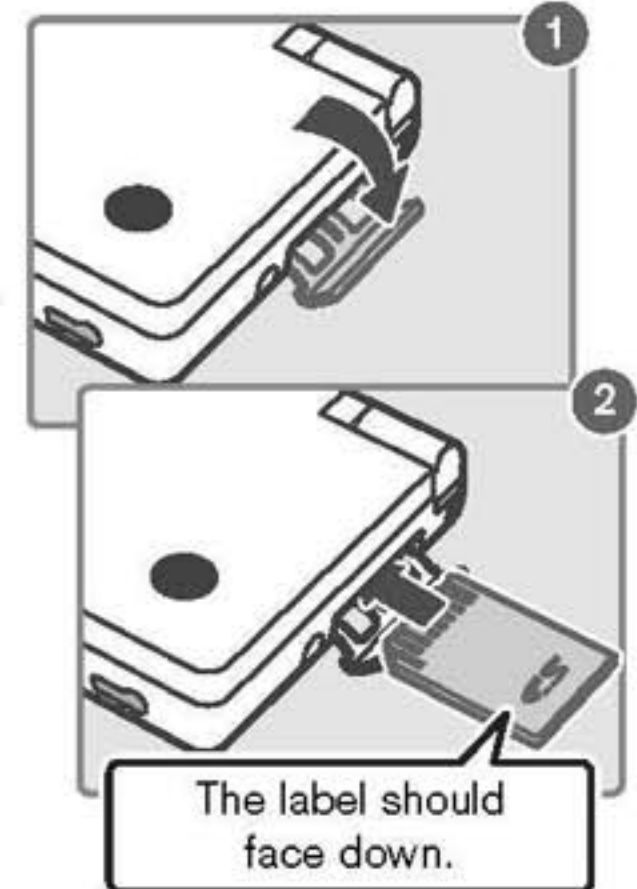

### How to Remove

- 1 Open the SD Card slot cover and press on the SD Card until it makes a clicking sound.
- 2 Take hold of the SD Card, remove it, and then close the slot cover.  
**Note:** Do not remove the SD Card while the system is reading or writing data. This could damage the system or the SD Card and destroy data.

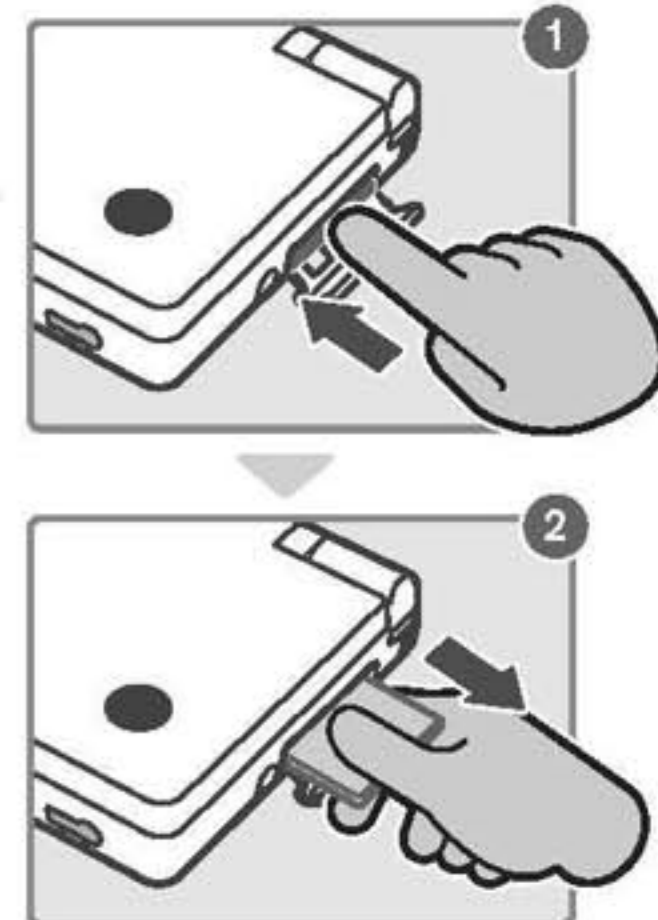



## Replacing the Nintendo DSi Rechargeable Battery Pak

If it becomes necessary to replace the Battery Pak, use the following procedure. Replacement Battery Paks are sold separately. Please contact your Nintendo Service Centre for further information on where to purchase a replacement. If you do not want to replace the Battery Pak on your own, you may send your Nintendo DSi system to the Nintendo Service Centre to have the Battery Pak exchanged by an authorised technician.

A parent or guardian should replace the Battery Pak if a young child is using the system.

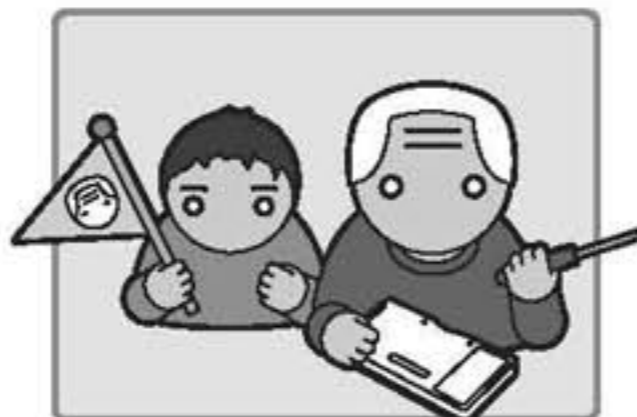

- 1 Always turn the power off and disconnect the Power Supply before replacing the Battery Pak.

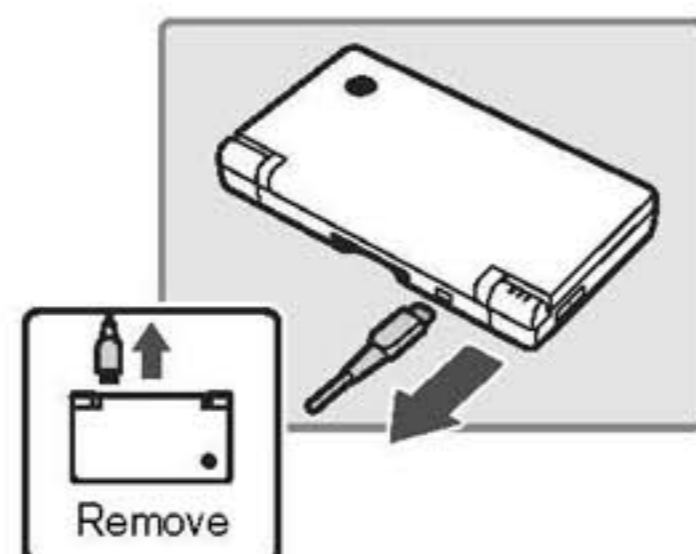
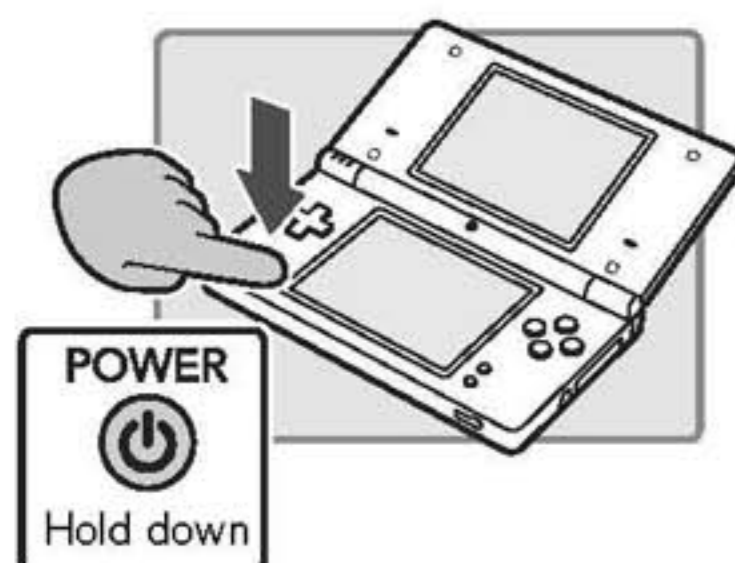

- 2 Using a screwdriver, loosen the screws on the battery cover. Remove the battery cover and retain. Always use an appropriate screwdriver for the screw. Using the wrong screwdriver may damage the head of the screw and you will not be able to remove the battery cover.

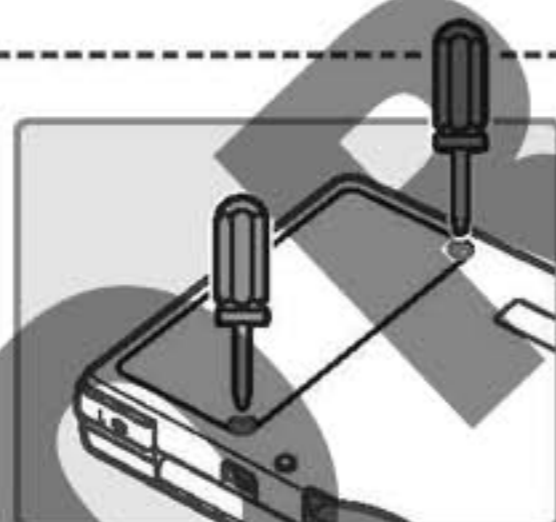

- 3 Use the protruding tab at the end of the Battery Pak to remove it from the Nintendo DSi.



- 4 Insert a new Battery Pak into the Nintendo DSi. Use only a new Nintendo DSi Battery Pak (TWL-003). Make sure to insert the new Battery Pak correctly, as shown in the illustration.

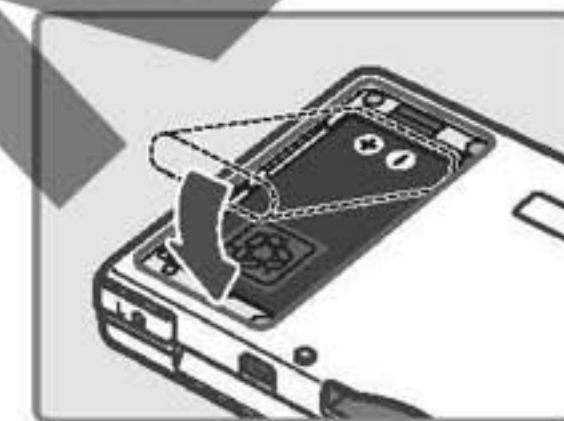
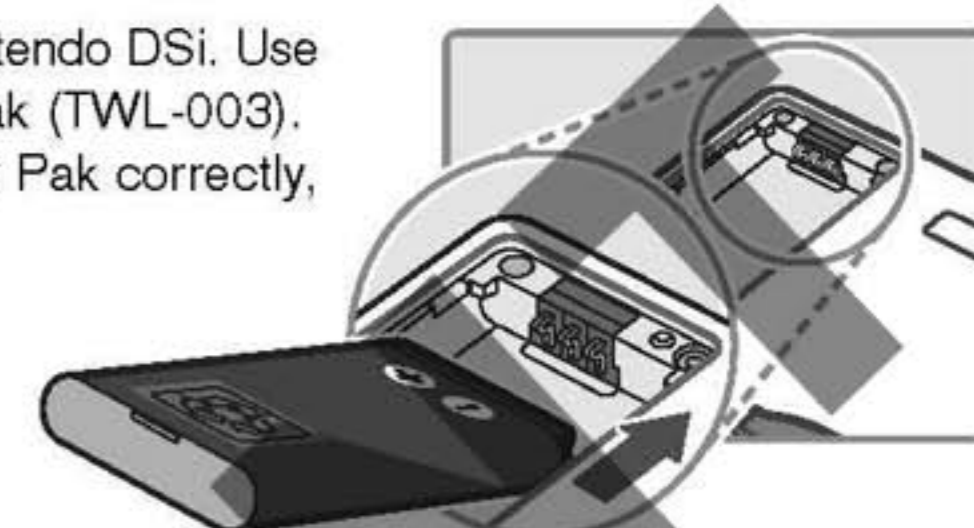

- 5 Replace the battery cover in its original position and carefully tighten the screws.

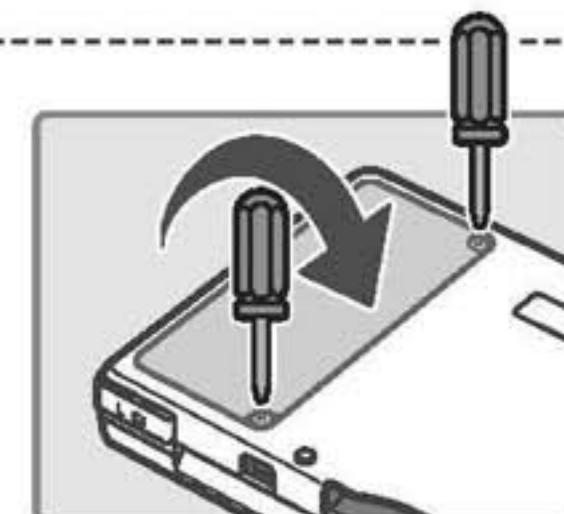

- 6 When disposing of the Rechargeable Battery Pak, please refer to the "Battery Disposal" information below.

### Battery Disposal

- Discarding batteries in your general household waste can be harmful to the environment. When disposing of the Battery Pak, follow appropriate local guidelines and regulations.
- In accordance with the Directive on Batteries and Accumulators and Waste Batteries and Accumulators (2006/66/EC), battery collection and recycling schemes should be in place in all EU Member States since 26 September 2008. If these schemes are available in your country, the Battery Pak should not be disposed of in your general household waste. For further information contact your local solid waste authority.

## Using the Nintendo DSi stylus and Touch Screen

The lower screen, or Touch Screen, is touch sensitive. For Nintendo DS system games that include this game control feature, operate the screen by using the included Nintendo DSi stylus. Lightly touch or slide the Nintendo DSi stylus across the Touch Screen.

### Important Nintendo DSi stylus and Screen Guidelines

- When operating the Touch Screen, please be sure to only use the Nintendo DSi stylus.
- Use only enough pressure to operate the game. Excessive pressure may damage the Touch Screen.
- Do not press on or slide the stylus across the upper screen.
- Do not use the Nintendo DSi stylus if it is broken.
- Place the Nintendo DSi stylus back in the stylus holder when not in use.

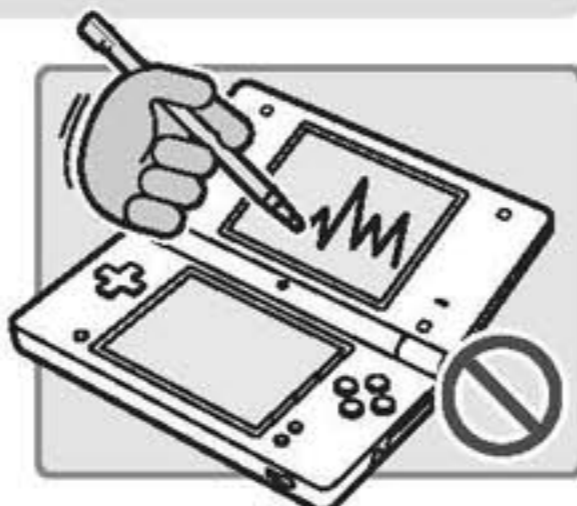

### Screen Cleaning Procedure

If the screens on your Nintendo DSi system have visible smudges, fingerprints on them or are contaminated with foreign material, they may not work properly and could become damaged. You can clean them by using a soft, clean cloth such as a lens cleaning cloth.

- 1 Slightly dampen the cloth with water **ONLY** and wipe the screens to loosen any dirt or foreign material.
- 2 Using a dry cloth, wipe the screens to dry them and finish the cleaning process. If needed, repeat the process.  
If the Touch Screen still does not work after cleaning, please contact the Nintendo Service Centre.

NINTENDO DS<sup>i</sup>

## Nintendo DSi Operations Manual

### Applications and Settings

The following points are explained in this section of the Operations Manual.

- Operating the Nintendo DSi Menu
- Built-in software
- System Settings
- Internet connection and settings

This section should be read in conjunction with the Basics section.

**Note:** Refer to the Support and Troubleshooting section if you think your product might be broken.

## Operating the Touch Screen

Use the stylus and the Touch Screen to operate the various menus and built-in software on the Nintendo DSi.

In this manual there are two terms used to describe the use of the stylus on the Touch Screen.

### Touch

Lightly pressing the stylus against the Touch Screen is known as "touching".

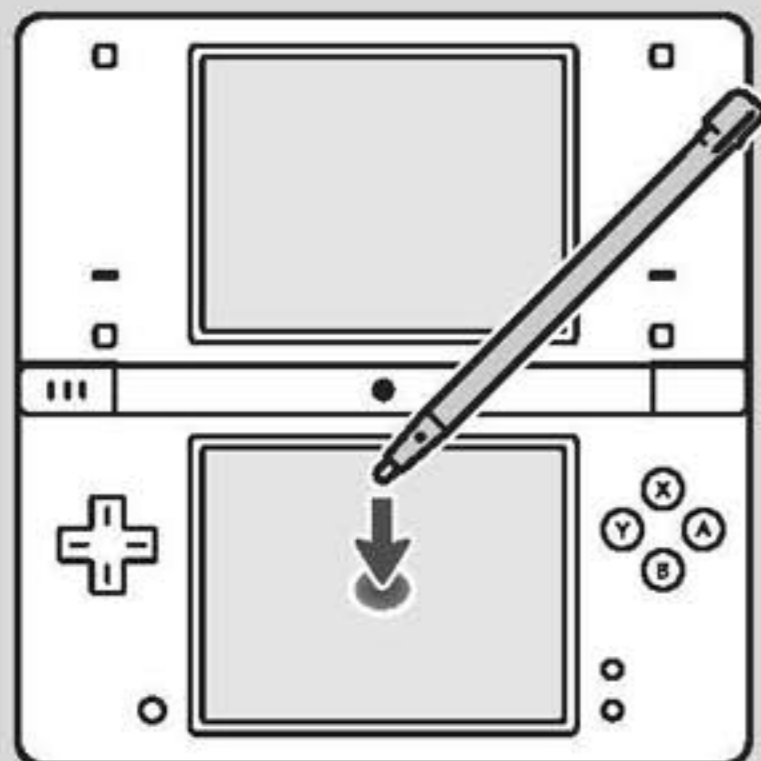

### Slide

Placing the stylus against and moving it over the surface of the Touch Screen is known as "sliding".

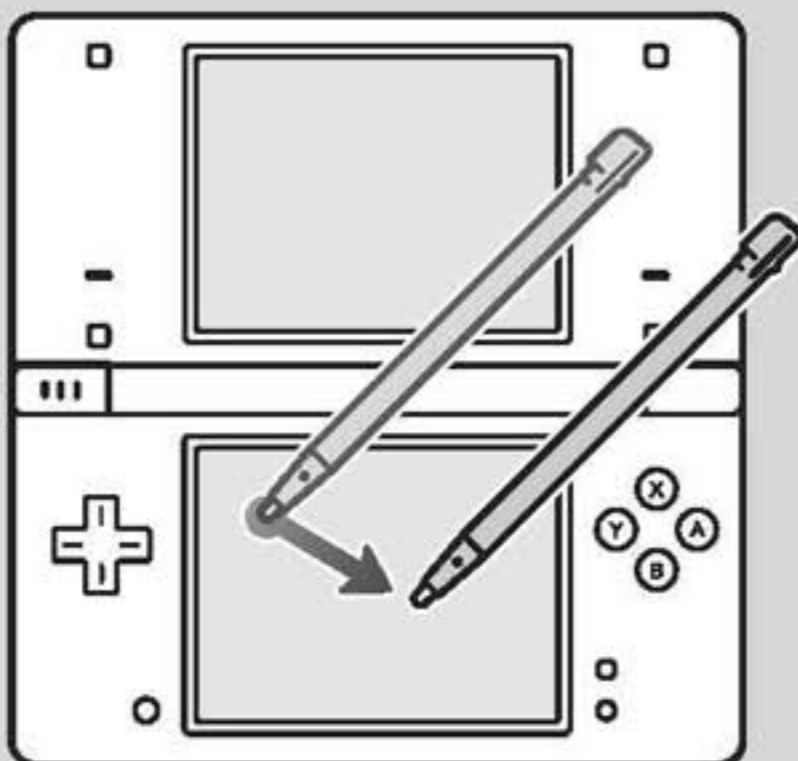

### When you cannot operate the Touch Screen properly

You can start the Nintendo DSi system on the **Touch Screen Calibration Screen** by taking the following steps when turning on the power. Try this if you are having trouble operating the Touch Screen.



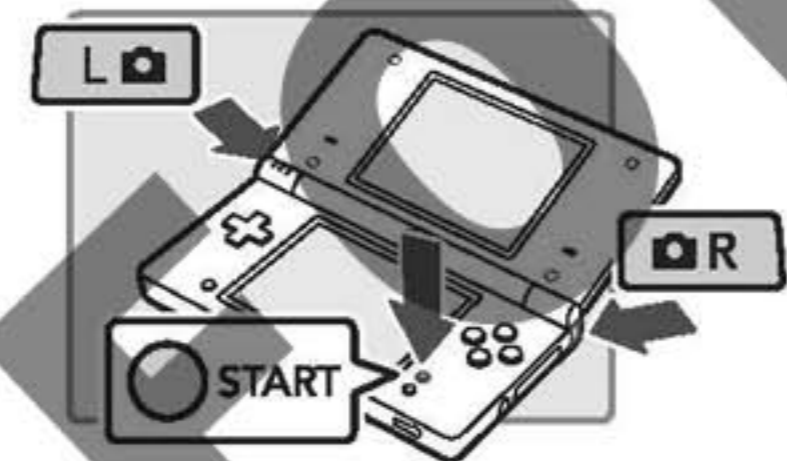



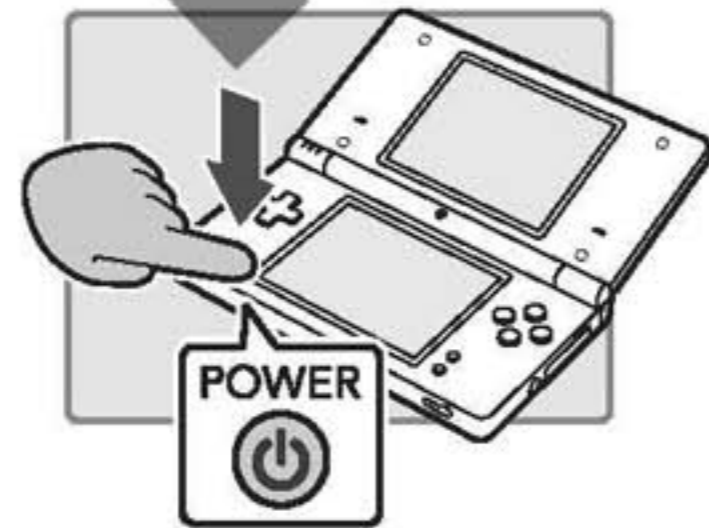

- 1 While pressing and holding L Button + R Button + START...



- 2 ...press the POWER Button.



## Contents

	Nintendo DSi Menu	26
	Screen Layout Explanation	26
	Camera Mode	28
	Using Game Cards	29
	Nintendo DSi Camera	31
	Getting Started	31
	Using the Cameras	32
	Viewing the Album	42
	Options (Exchanging Photos/Frames, Copying, Deleting)	44
	Calendar	48
	Nintendo DSi Sound	49
	Starting Nintendo DSi Sound	49
	Recording and Playing with Sounds	50
	Playing with Music on an SD Card	55
	Settings	58
	Nintendo DSi Shop	59
	What are Nintendo DSi Points?	59
	How to Redeem Nintendo DSi Points	60
	DS Download Play	62
	Using DS Download Play	62
	PictoChat	63
	Starting PictoChat	63
	Controls	64
	System Settings	66
	System Settings	66
	Data Management	68
	DS Wireless Communications/Brightness Settings	69
	Profile	70
	Date/Time/Alarm	71
	Parental Controls	72
	Touch Screen Calibration/Mic Test	77
	Internet	78
	System Update/Format System Memory	94
	Using the Keyboard	95
	Others	96
	Glossary	96
	Error Messages and Error Codes	98



## Nintendo DSi Menu

The **Nintendo DSi Menu** appears automatically when you turn the system's power on. On this menu you will see icons for the system's built-in applications and for any Nintendo DS Card, Nintendo DSi compatible Card or Nintendo DSi Card inserted into the Game Card slot. Touch these icons to play games, use the applications, or enter **SYSTEM SETTINGS**. You can also press the L Button or R Button to enter **Camera Mode** and take photos.

### Screen Layout Explanation

The screenshot shows the Nintendo DSi Menu interface with the following labeled components:

- User name:** NINTE JOHN
- Date & time:** 03/04 10 00
- Volume level:** Indicated by a speaker icon and a volume bar.
- Battery charge:** Indicated by a battery icon and a charge level bar.
- User-taken photo:** A photo of a cat is displayed in the center.
- Application name:** Nintendo DSi Camera Nintendo
- Start icon:** A camera icon with the word "START" below it.
- Application list:** A row of application icons including System Settings, Nintendo DSi Camera, Nintendo DSi Sound, DS Download Play, Nintendo DSi Shop, and PictoChat™.

Use the stylus or the **+** Control Pad to scroll through applications.

**Application list:** Here are the icons you'll see on the application list.

### Card Software Icons



This icon appears when there's no Game Card inserted in the Game Card slot.



When a Game Card is inserted in the Game Card slot, an icon for that game will appear. The icon for **THE LEGEND OF ZELDA: PHANTOM HOURGLASS** is shown here.

### Built-in Application Icons

These are the icons of the system's built-in software applications.



System Settings

Page 66 →



Nintendo DSi Camera

Page 31 →



Nintendo DSi Sound

Page 49 →



Nintendo DSi Shop

Page 59 →



DS Download Play

Page 62 →



PictoChat™

Page 63 →

### Others



**Open Box Icon**

This icon appears when no application is present. The number of empty boxes represents the number of applications that can be added.



**Present Icon**

This icon appears when you add a new application by purchasing it via Nintendo DSi Shop, or through some other means. Touch a present icon to unwrap the application icon.

### Moving Icons

- Hold the stylus on the icon you want to move, and slide the stylus up or down to pull the icon out of sequence. You can also press left and right on the **+** Control Pad to select the icon, then press up to move it up.
- Scroll through the list until you find where you want to place it.
- Place the icon into its new location and lift the stylus off the screen, or press down on the **+** Control Pad.
- That's it! You're done.

## Camera Mode

On the **Nintendo DSi Menu**, press the L Button or R Button to enter **Camera Mode**.

**Note:** Photos you take will be saved to the Nintendo DSi System Memory.



Number of photos remaining

Start Nintendo DSi Camera [Page 31 →](#)

Take a photo (L Button, R Button, or A Button)

Switch between inner and outer cameras (X Button)

Return to the **Nintendo DSi Menu** (B Button)

Turn the menu display on and off (Y Button)

**Note:** You can also use the buttons shown in brackets.

## Top Screen Photo Display

- Photos taken in **Camera Mode** will appear on the top screen of the **Nintendo DSi Menu**.



- If you have taken multiple photos in **Camera Mode**, the photo that appears on the top screen will change every time you turn the Nintendo DSi system on or exit **Sleep Mode** by opening the Nintendo DSi system.

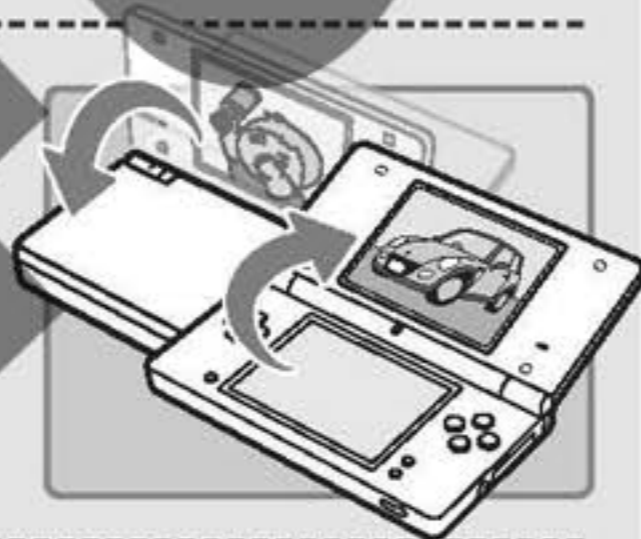

- You can use the Nintendo DSi Camera photo album to select which photos appear on the top screen.

[Page 42 →](#)

Album Screen in  
Nintendo DSi Camera



## Using Game Cards

### Starting a Game

- 1 Insert a Game Card in the Game Card slot. If you have trouble inserting the Game Card, remove it and check that it is facing the right direction.

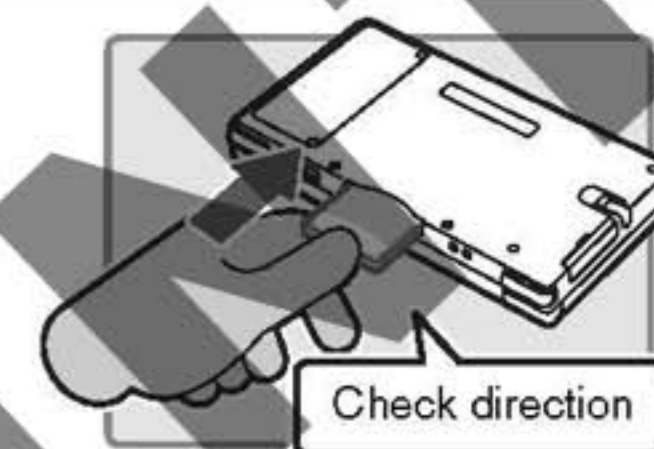

- 2 Press the POWER Button.

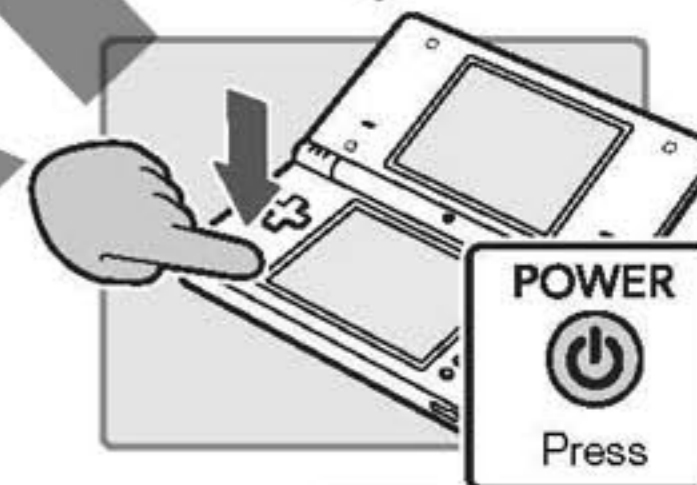

- 3 Touch the Game Card icon.

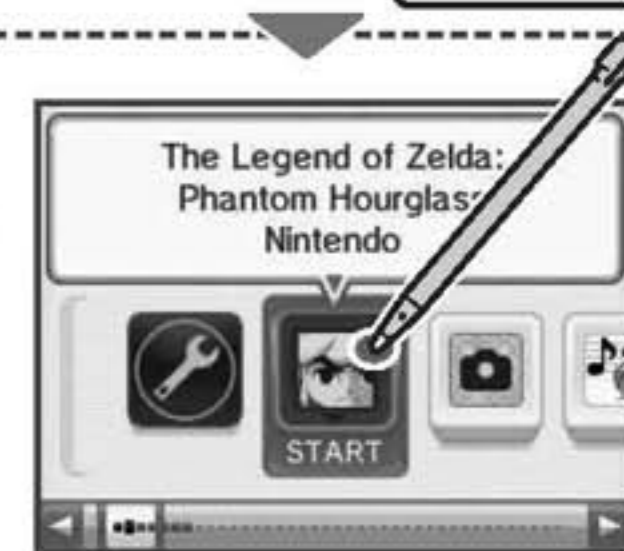

- 4 Refer to the game's Instruction Booklet for game play information.

### Exiting a Game

- 1 Press and hold the POWER Button.

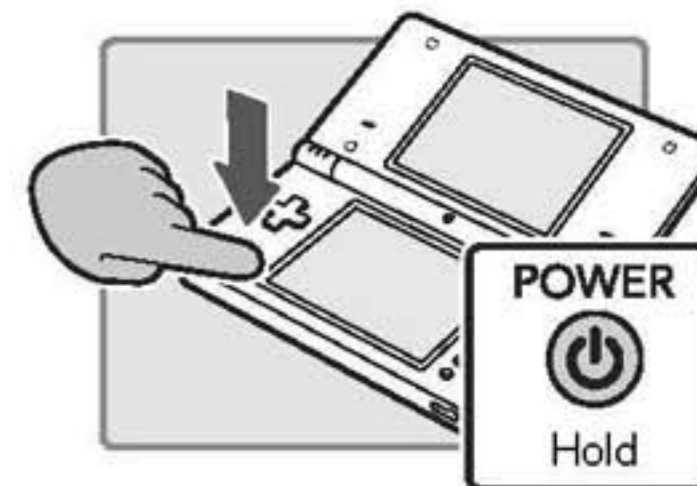

- 2 Press in and then pull out the Game Card. Be careful that you don't press and release the Game Card too hard, or it might pop out quickly.

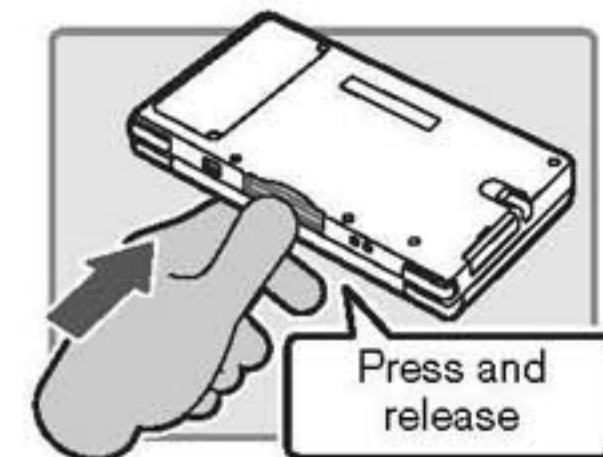

- 3 Put the stylus into the stylus holder.

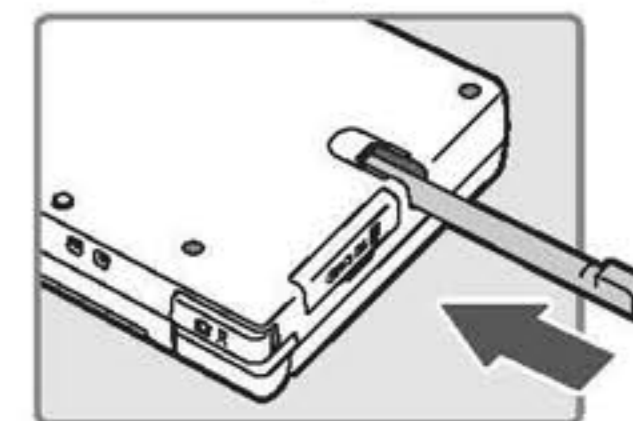

## Incompatible Nintendo DS Software and Peripherals

The following software and peripherals cannot be used on Nintendo DSi.



- Nintendo DS Browser Card
- Nintendo DS Memory Expansion Pak (NTR-011)
- Nintendo DS Lite Memory Expansion Pak (USG-007)

- 
- Nintendo DS Rumble Pak (NTR-008)



In addition to these products, it is not possible to use any peripherals that would connect to the Nintendo DS or Nintendo DS Lite systems via the Game Boy Advance Game Pak slot or anything that functions in conjunction with a Game Boy Advance Game Pak.

## Nintendo DSi Camera

With the Nintendo DSi Camera, you can use 11 different types of lens to take photos, watch slideshows of your photos, and exchange photos with other Nintendo DSi systems.



## Getting Started

When you start Nintendo DSi Camera, you will have several options available. Touch the Touch Screen to make a selection.

## Screen Layout Explanation

Switch to the Nintendo DSi System Memory

Switch to SD Card\*

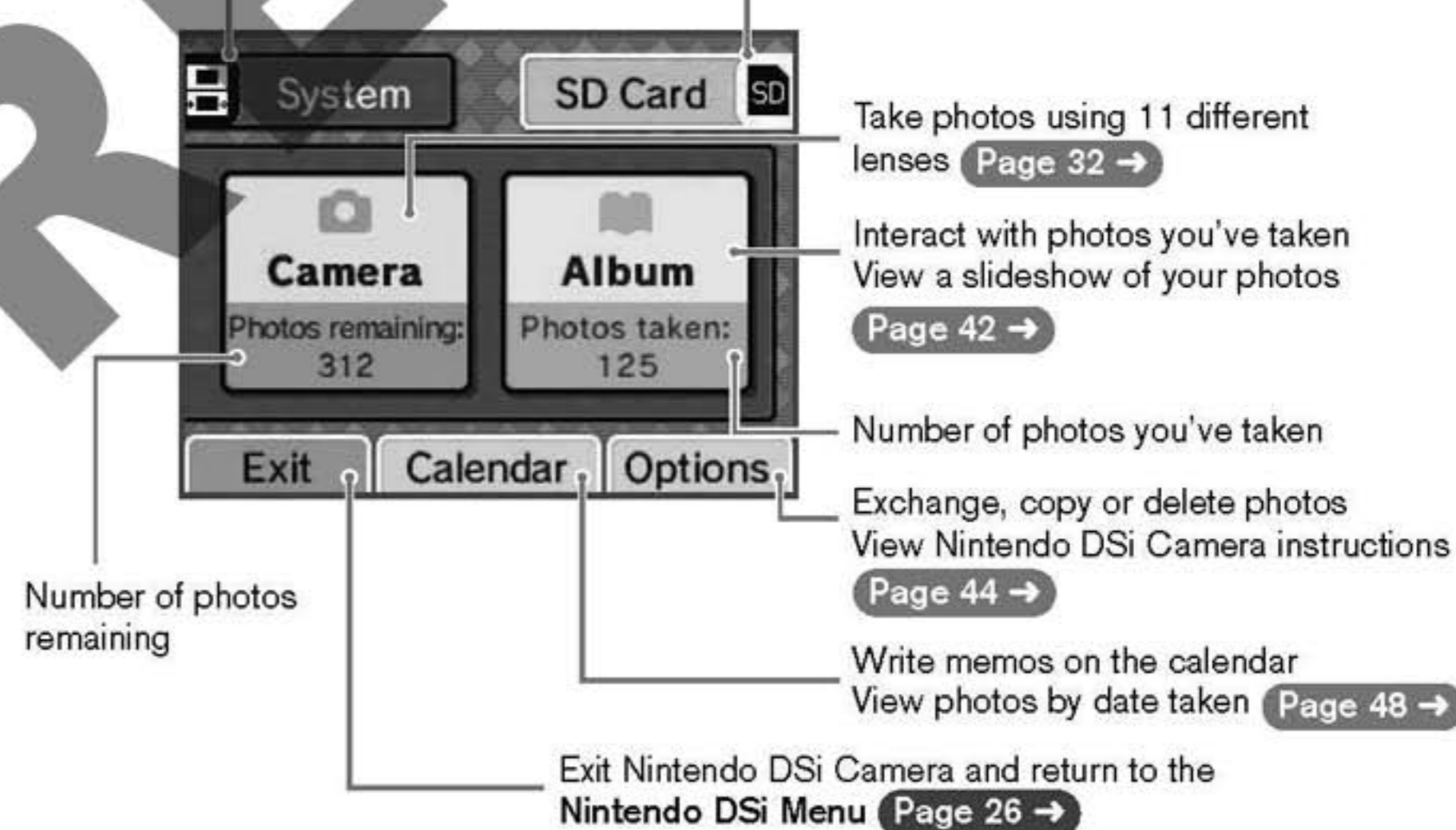

\*By saving to an SD Card, you can view your photos on a computer or print them out. (This requires a computer that can read SD Cards.)

## How Many Photos Can I Save?

- Check the PHOTOS REMAINING display to see how many photos you can save in your selected location. Because the size of photo data can vary, this number is only a rough indicator – it does not reflect a precise number of photos.
- Since photo data size varies, taking one photo may also decrease remaining photos by two or even none at all.

- SD Cards can save up to a maximum of 3,000 photos, regardless of how much free space they have available.

## Selecting a Lens

Touch CAMERA in the **Nintendo DSi Camera Menu** to view the **Lens-Selection Screen**. Touch the icon representing the lens you want to use, and then touch START to begin using that lens.

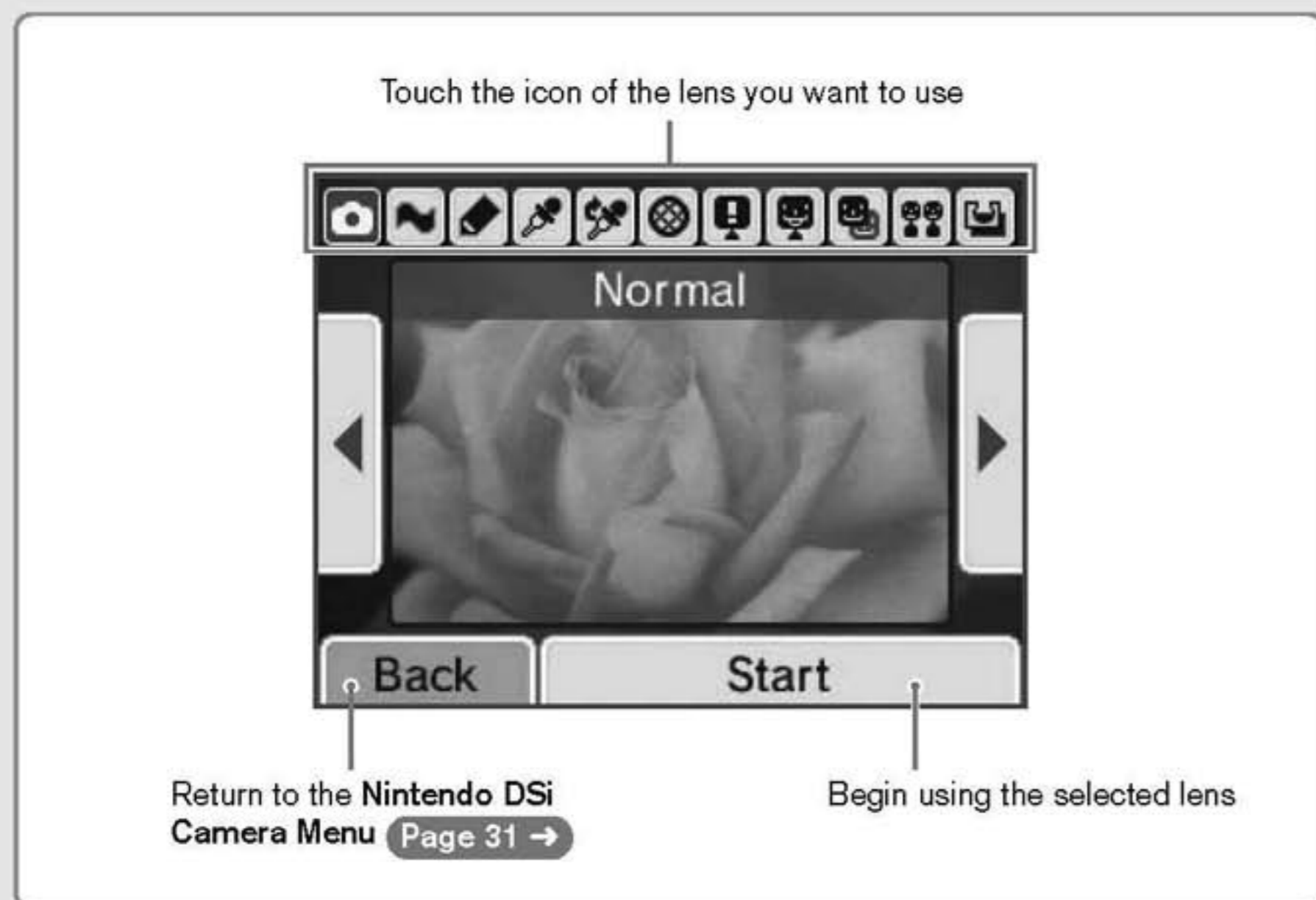

Restore colour to black-and-white photos.

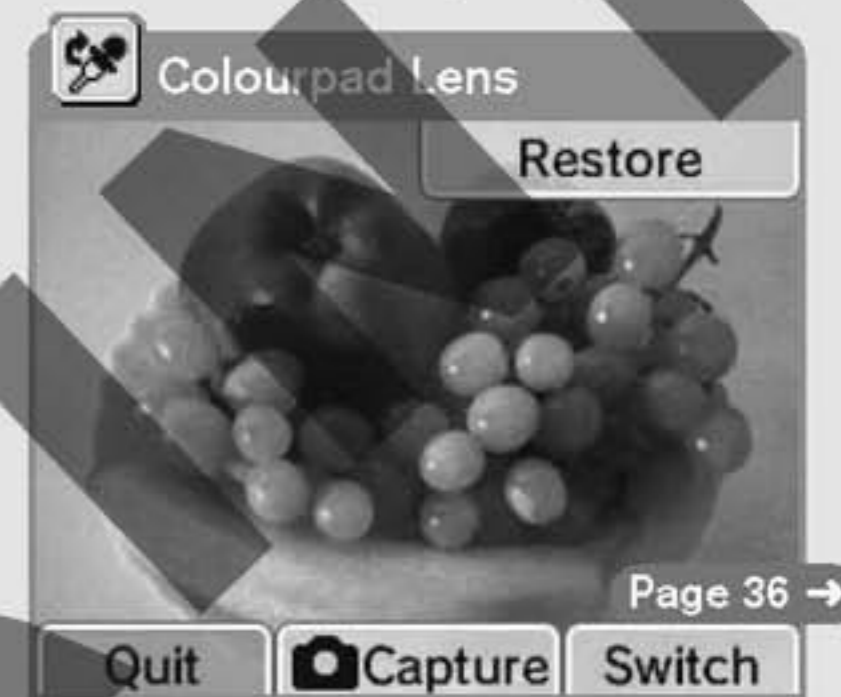

Alter colours in your photos.

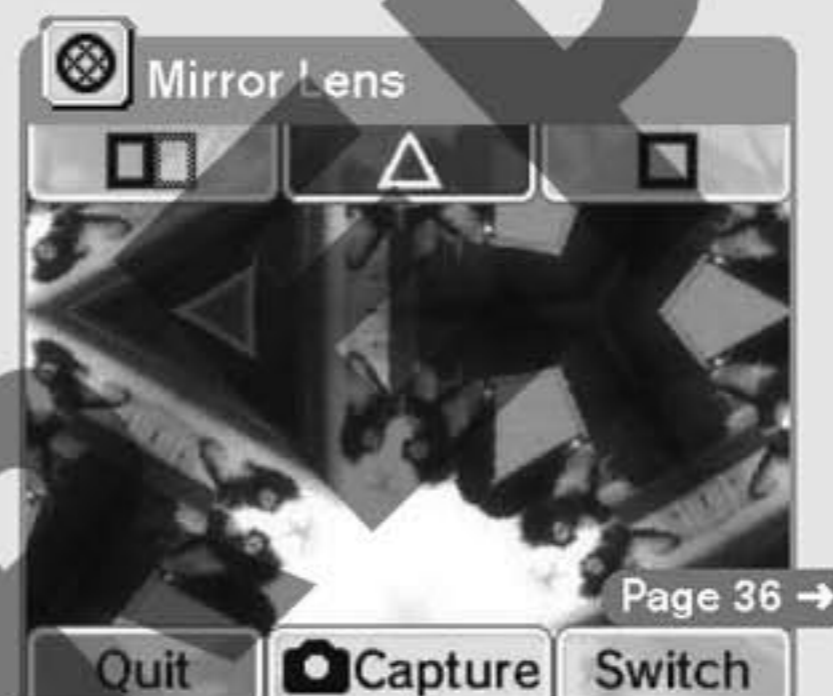

Apply a variety of mirror effects.



Add mischievous effects to faces.

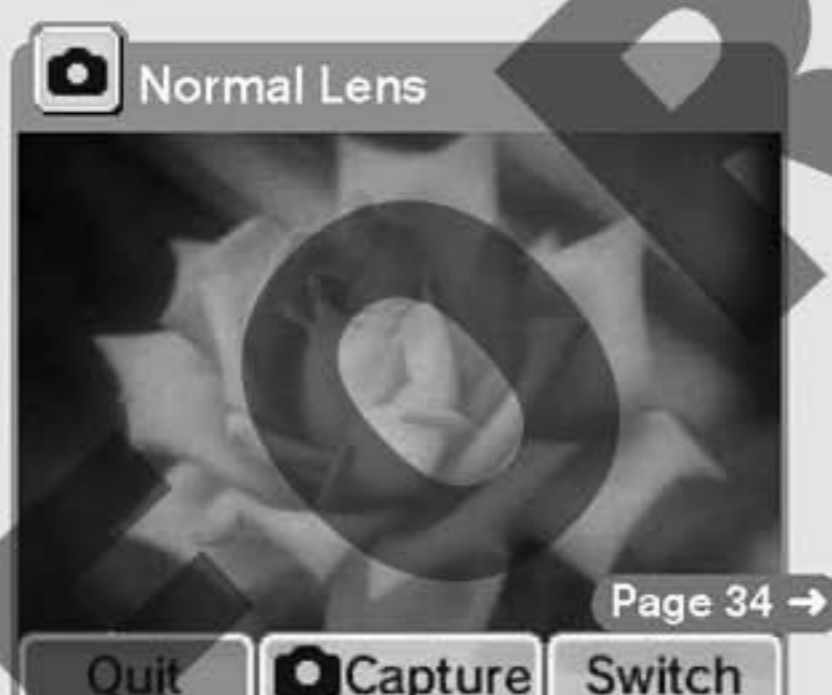

Take normal unaltered photos.



Change facial expressions.



Blend photos of two faces together.



Slide the stylus across the Touch Screen to distort the image.



Doodle on your photos.

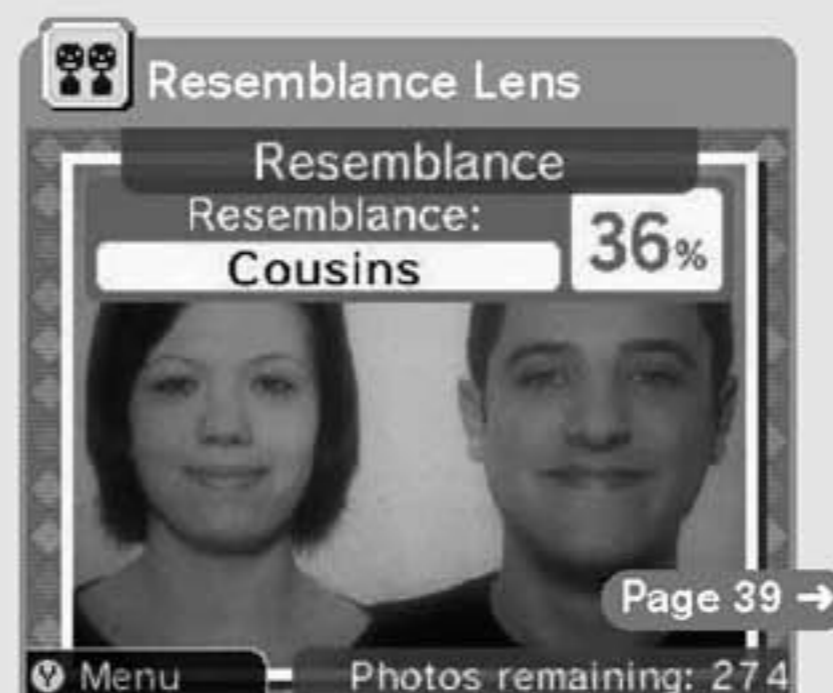

Evaluate how similar two faces are.

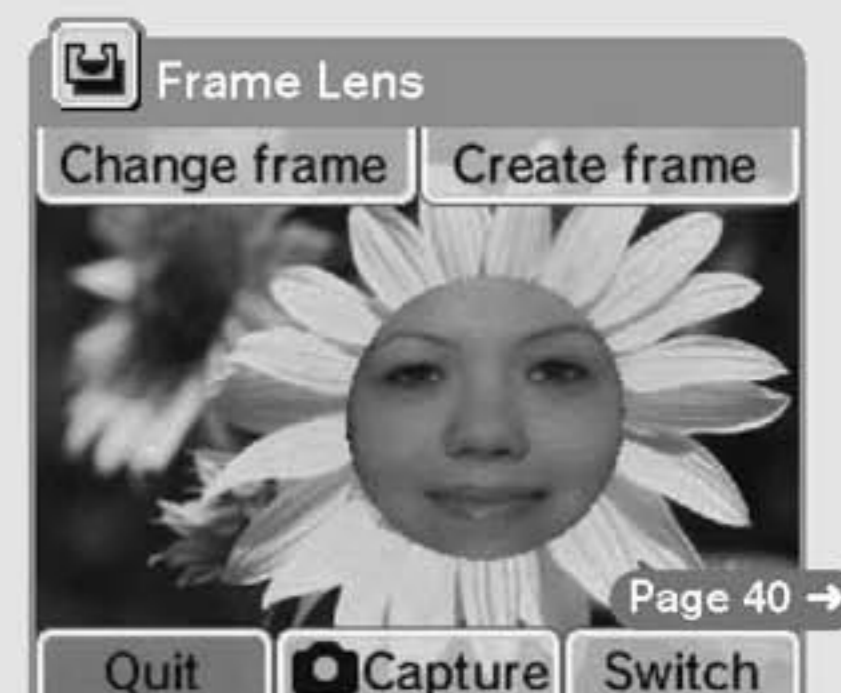

Create frames and take photos within those frames.



## Normal Lens

This lens works like a normal camera and has no special effects.

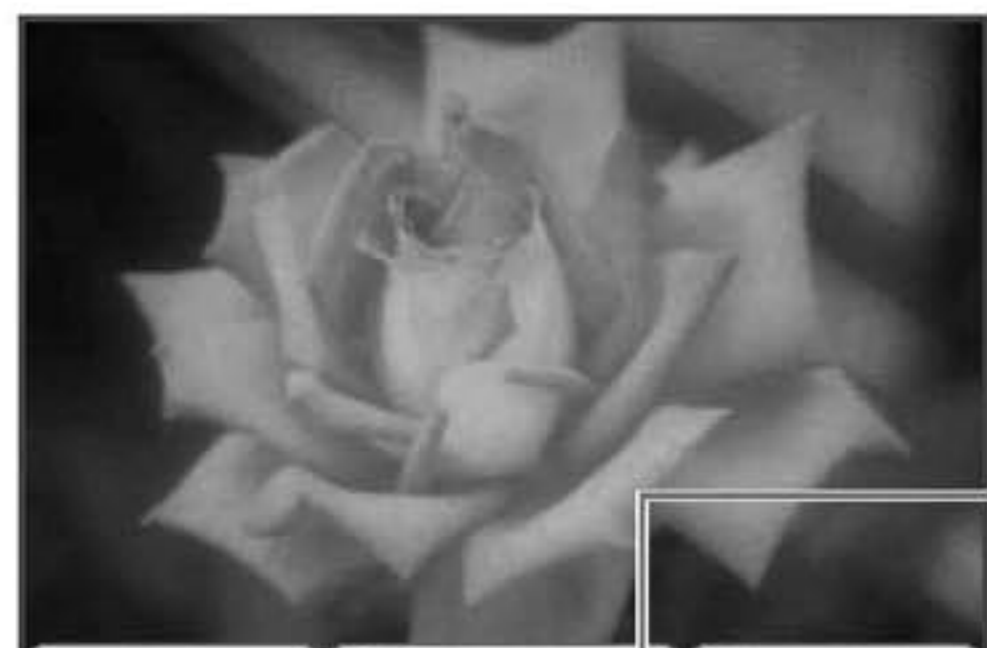

Take a photo  
(L Button, R Button or A Button)

Switch between the inner and outer  
camera (X Button)

Quit Capture Switch

Return to **Lens-Selection Screen** (B Button) [Page 32](#) →

The menu display for icons like **Capture** can be toggled on and off (Y Button)

**Note:** These controls are the same for all lenses. You can also use the buttons shown in brackets.

## Distortion Lens

Use this lens to distort the image by sliding the stylus across the Touch Screen.

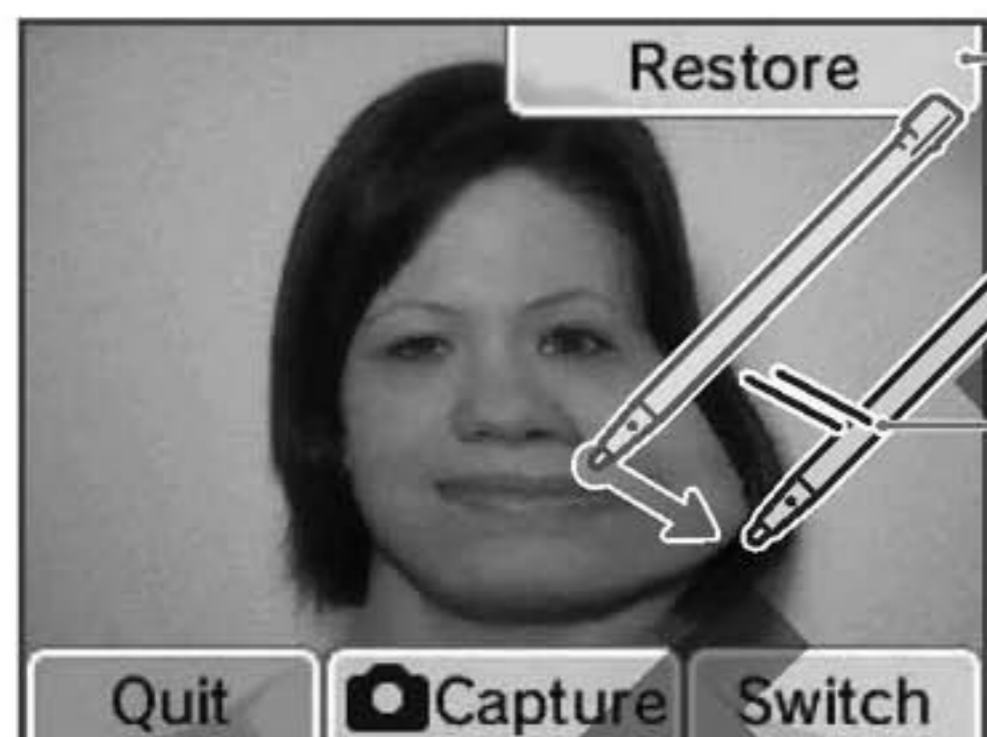

Restore

Restore the distorted image to normal

The photo gets stretched in the  
direction you move the stylus

Quit Capture Switch



Restore

Quit Capture Switch



Restore

Quit Capture Switch



Restore

Quit Capture Switch

## Graffiti Lens

Use this lens to decorate your photos using pens and stamps.

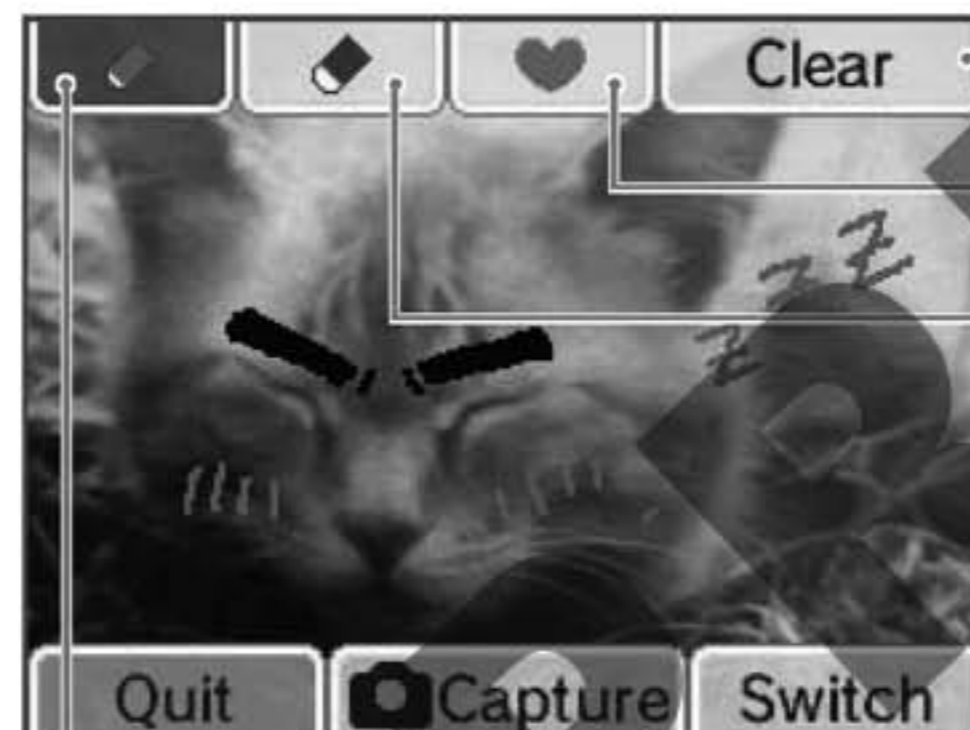

Erase all graffiti

Use a stamp

Use an eraser

There are three eraser sizes.

Quit Capture Switch

Use pens or droppers (you can select pen colour and thickness)

You can set your pen colour to any colour you see on screen by using the dropper.

### Using Droppers

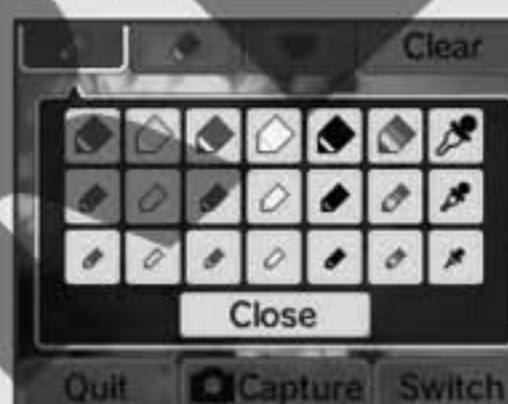

1 Select a dropper



2 Touch any colour



3 The pen changes to  
the colour you touched

## Colour Lens

This lens converts the image to black-and-white. Any colour can be added back into the image by simply touching the screen.

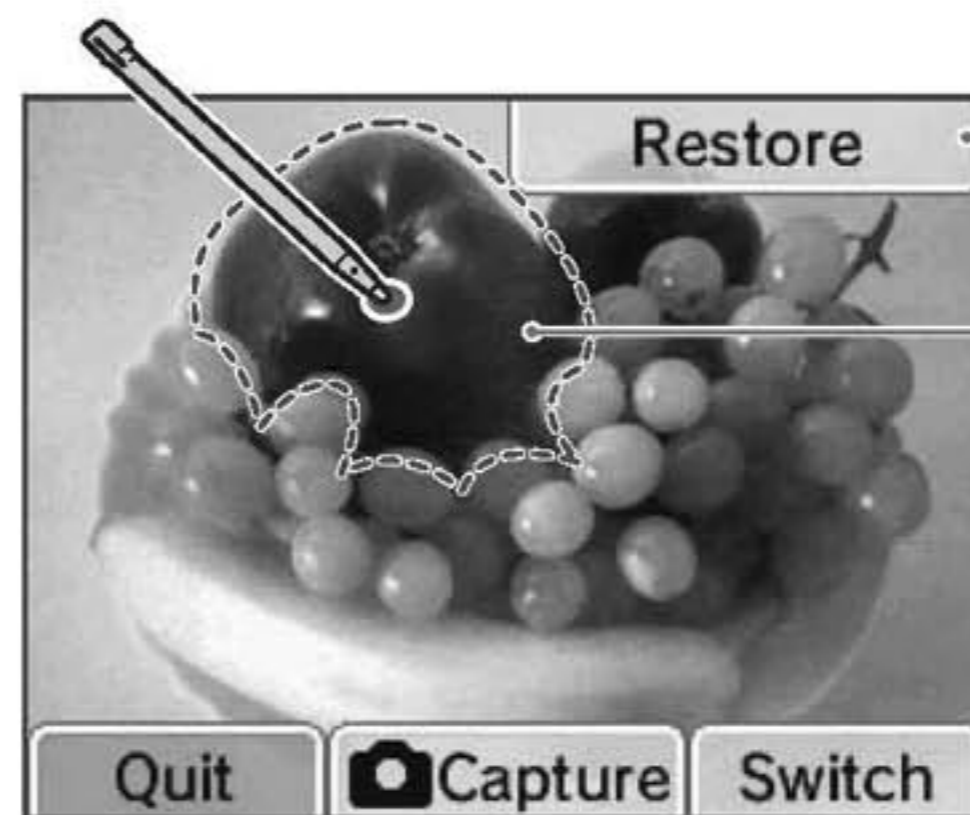

Restore

Restore the entire screen to  
black-and-white

This colour has been added back into  
the image

Quit Capture Switch

## Using the Cameras

### Colourpad Lens

Use this lens to change the colours in your photos. Each time you touch a colour it will change.

**Note:** Touching white, black or grey areas will not change their colour.

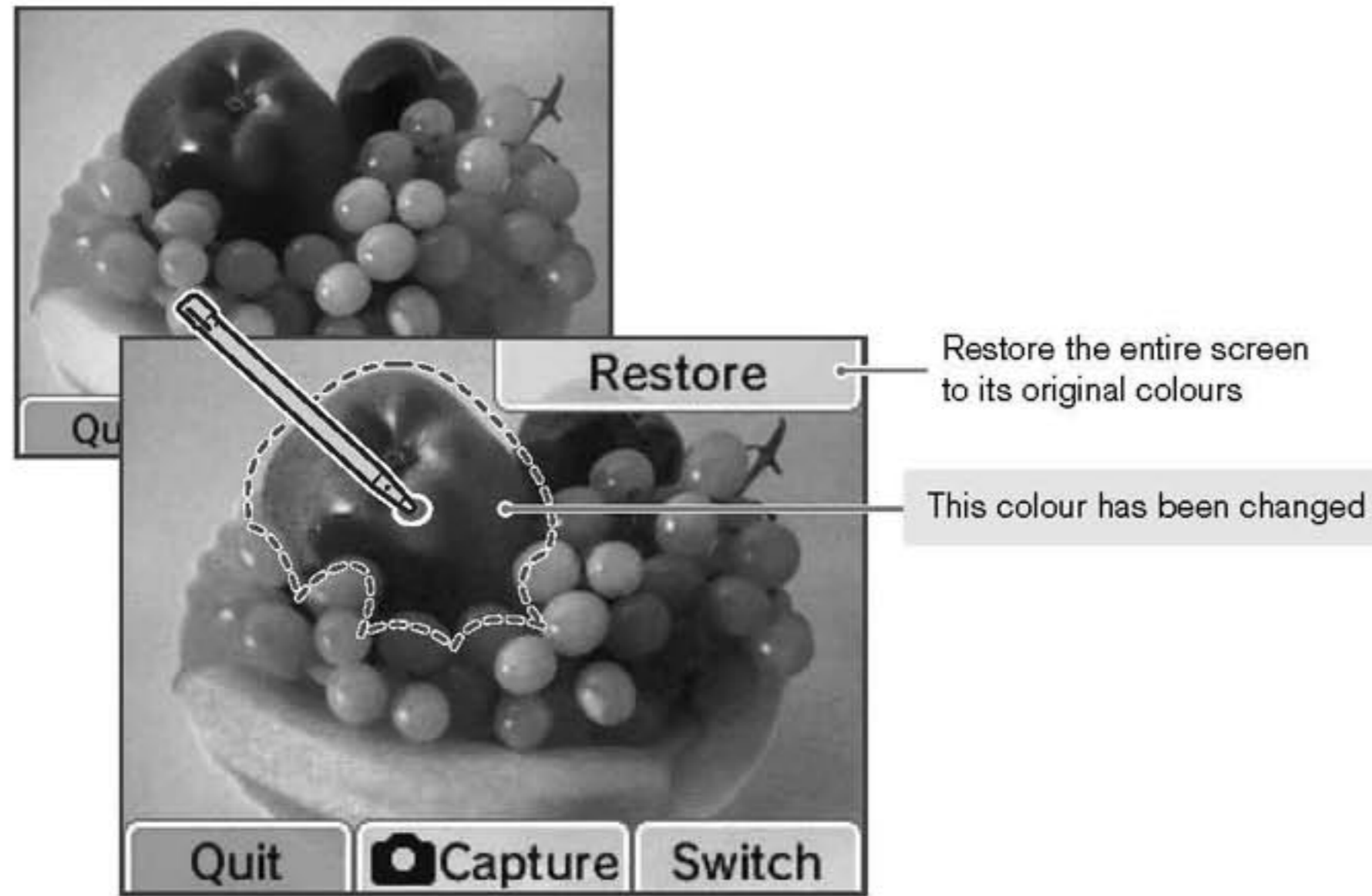

### Mischief Lens

Use this lens to add special effects to the faces in your image.

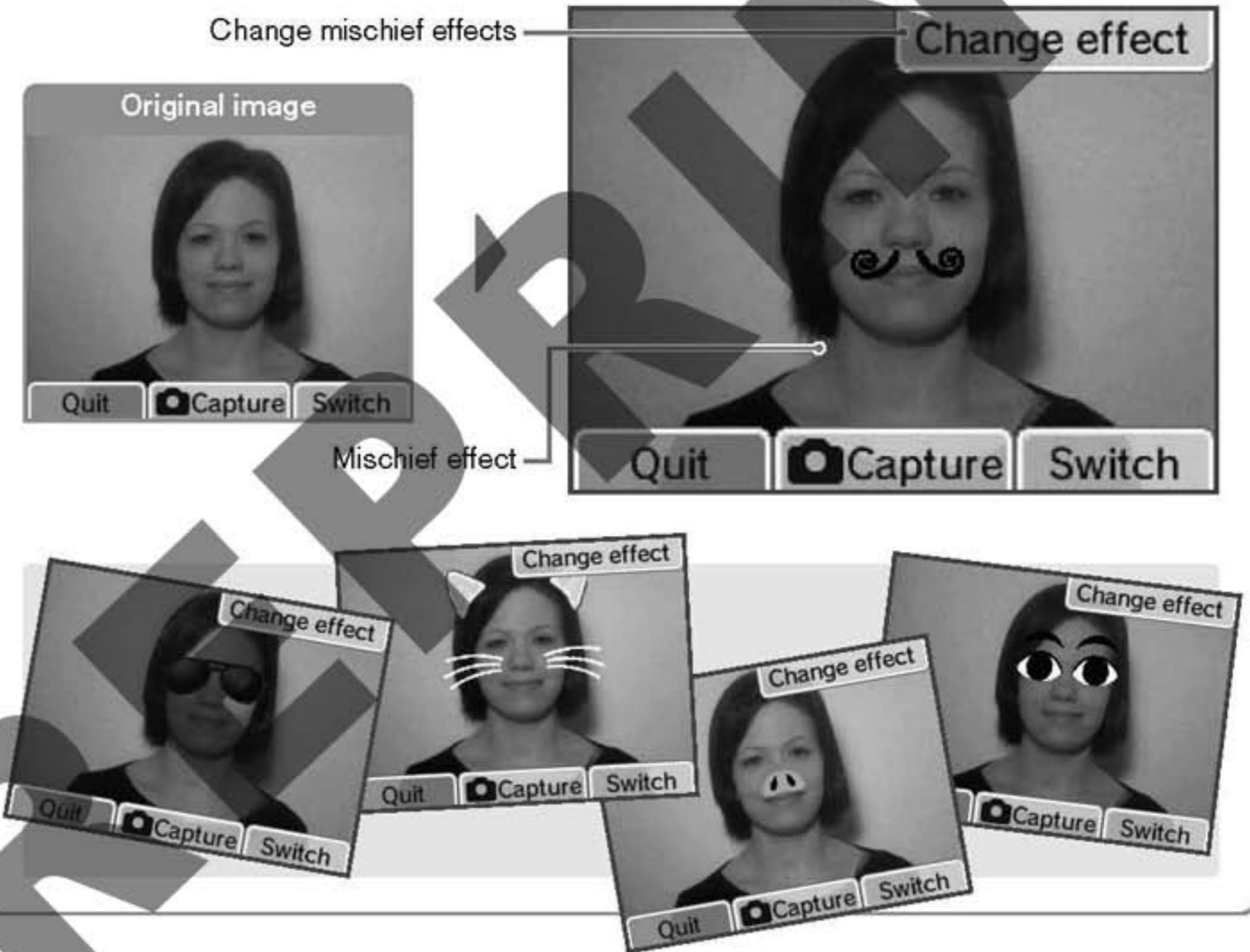

### Mirror Lens

Use this lens to add mirror effects to your photos.

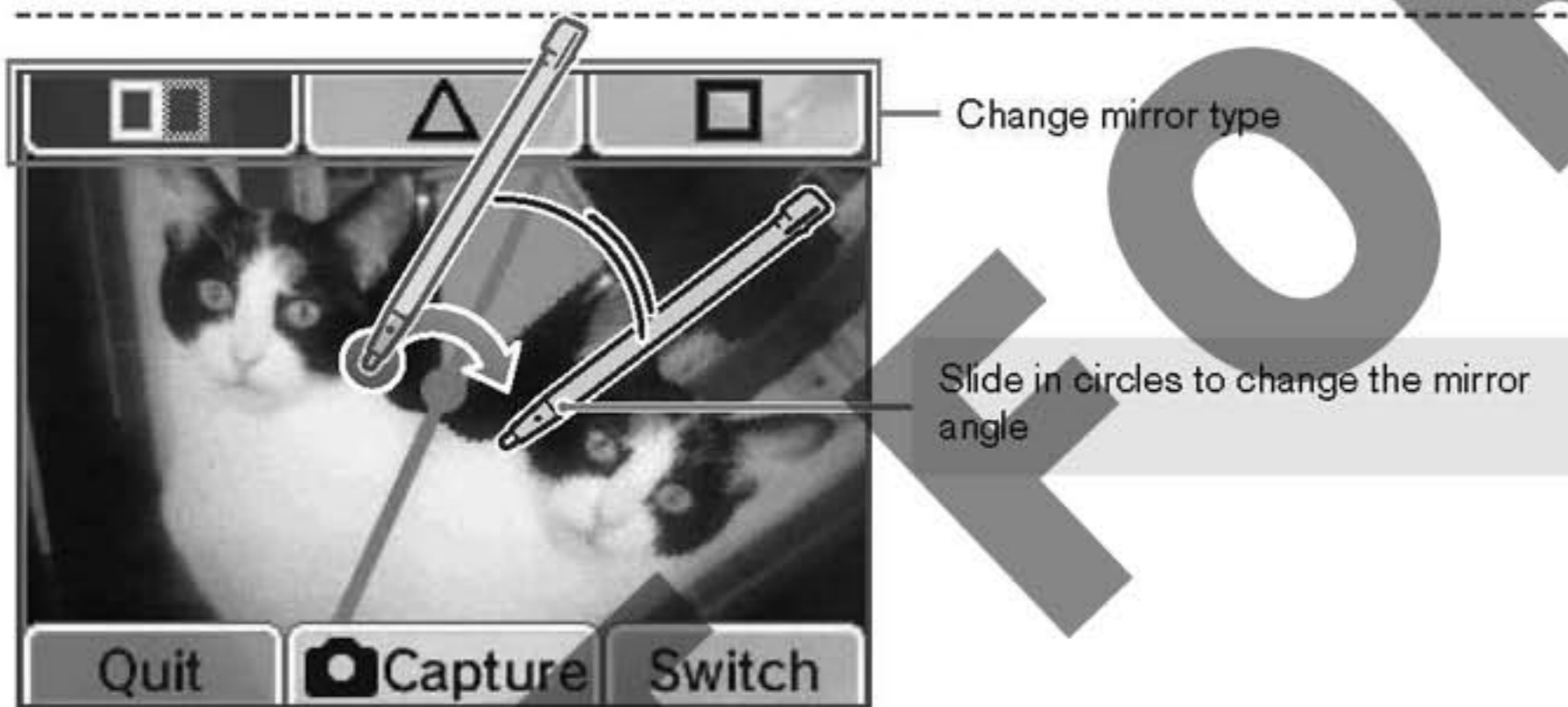

□ Split mirror

△ Triangular mirror

□ Square mirror

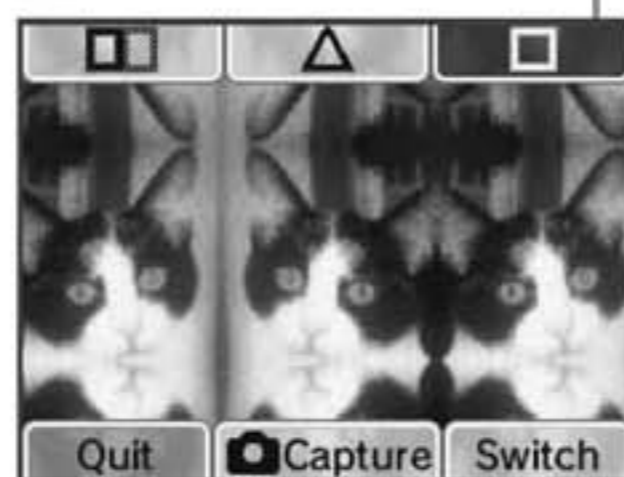
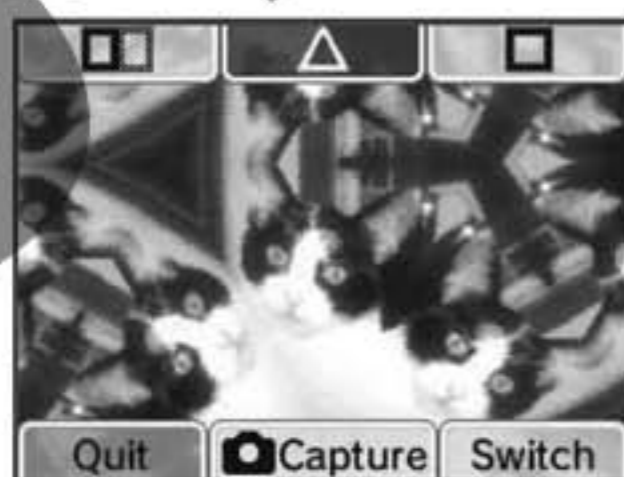

### Emoter Lens

Use this lens to change the expressions on the faces in your image.

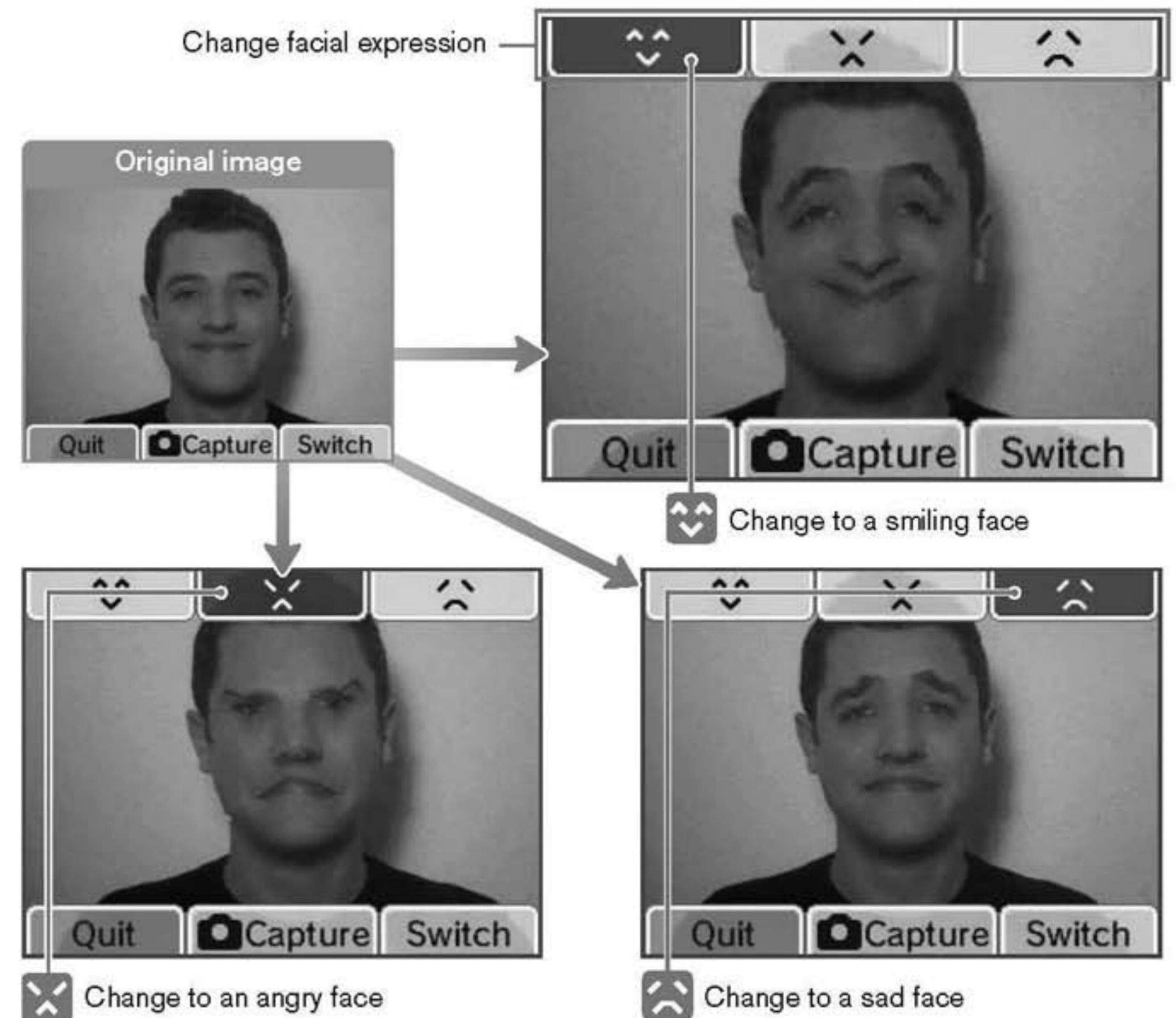



## Merge Lens

Use this lens to blend the photos of two faces together.

- 1 Capture a photo of the first face.  
Try to get the face as large as possible and centred on the Touch Screen.



- 2 Capture the second face as you did the first.  
It's easier to merge the faces if the second face is as close as possible in size and position to the first face.



- 3 Once you have the results of the merge, touch or to change the merge ratio (%) of the two faces.

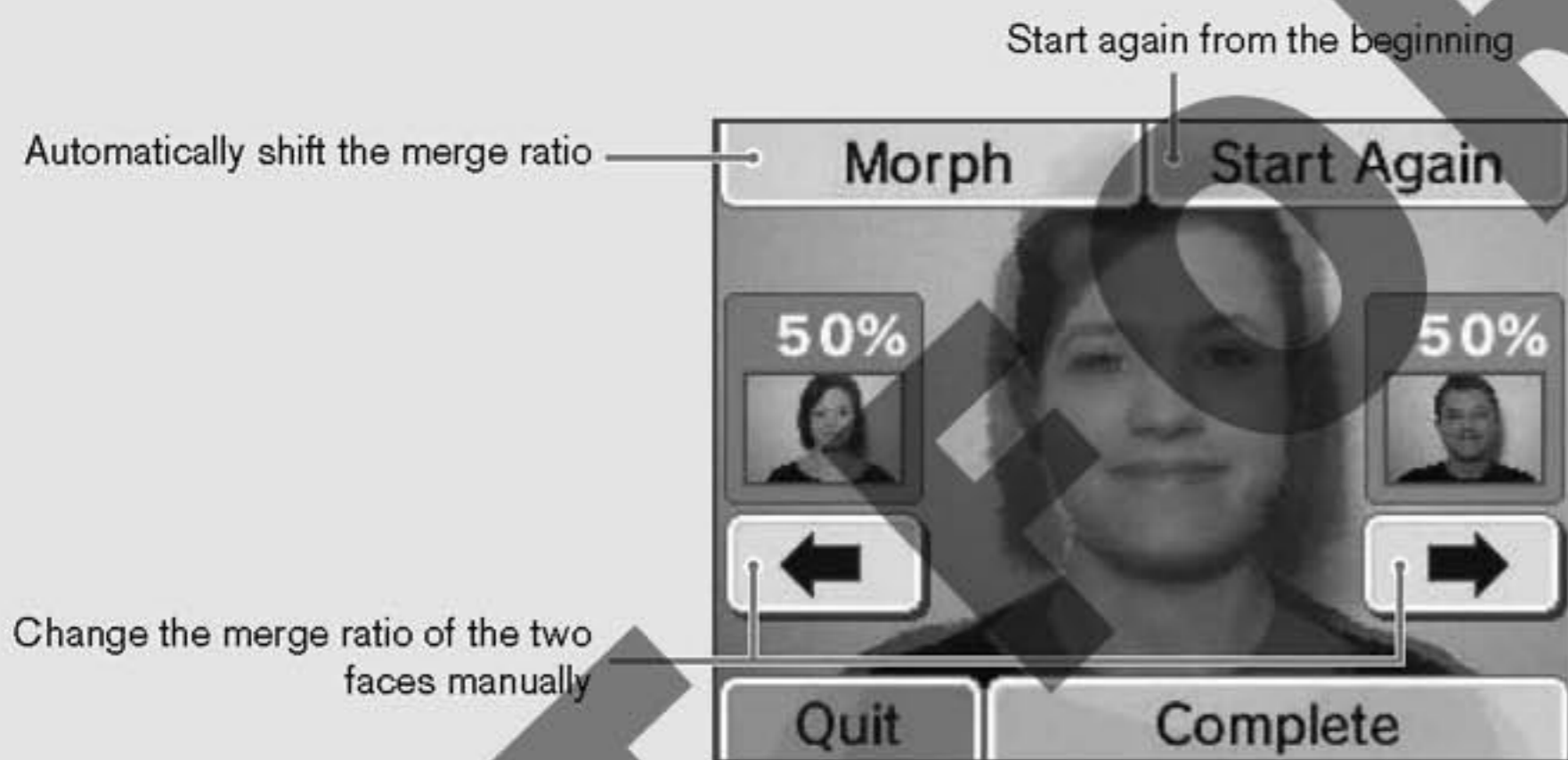

- 4 Touch to save the image.



## Resemblance Lens

Use this lens to evaluate how similar two faces are.

- 1 Line up two faces on the screen.  
A square frame will appear around a face once it has been recognised.



- 2 When both faces have been recognised, touch .



- 3 The resemblance results will appear, and the photo will be saved.

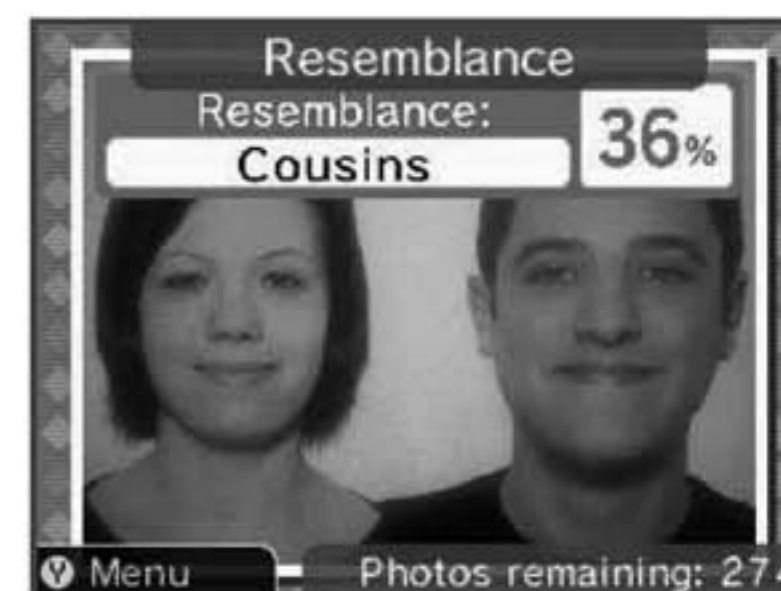

### Warnings Regarding Face Recognition

For more precise facial recognition when using the Mischief, Emoter, Merge or Resemblance lenses, pay attention to the following points:



Take photos in a bright environment.



Capture the whole face on-screen.



Capture the face from the front.



Don't tilt the head.



Lift fringe to make eyebrows visible.



Take off glasses.

Please keep in mind that following these steps may not ensure perfect facial recognition.

## Frame Lens

This lens can be used to take photos within frames (photos with part of the image removed). You can use one of the default frames included with Nintendo DSi Camera or you can create your own to use.

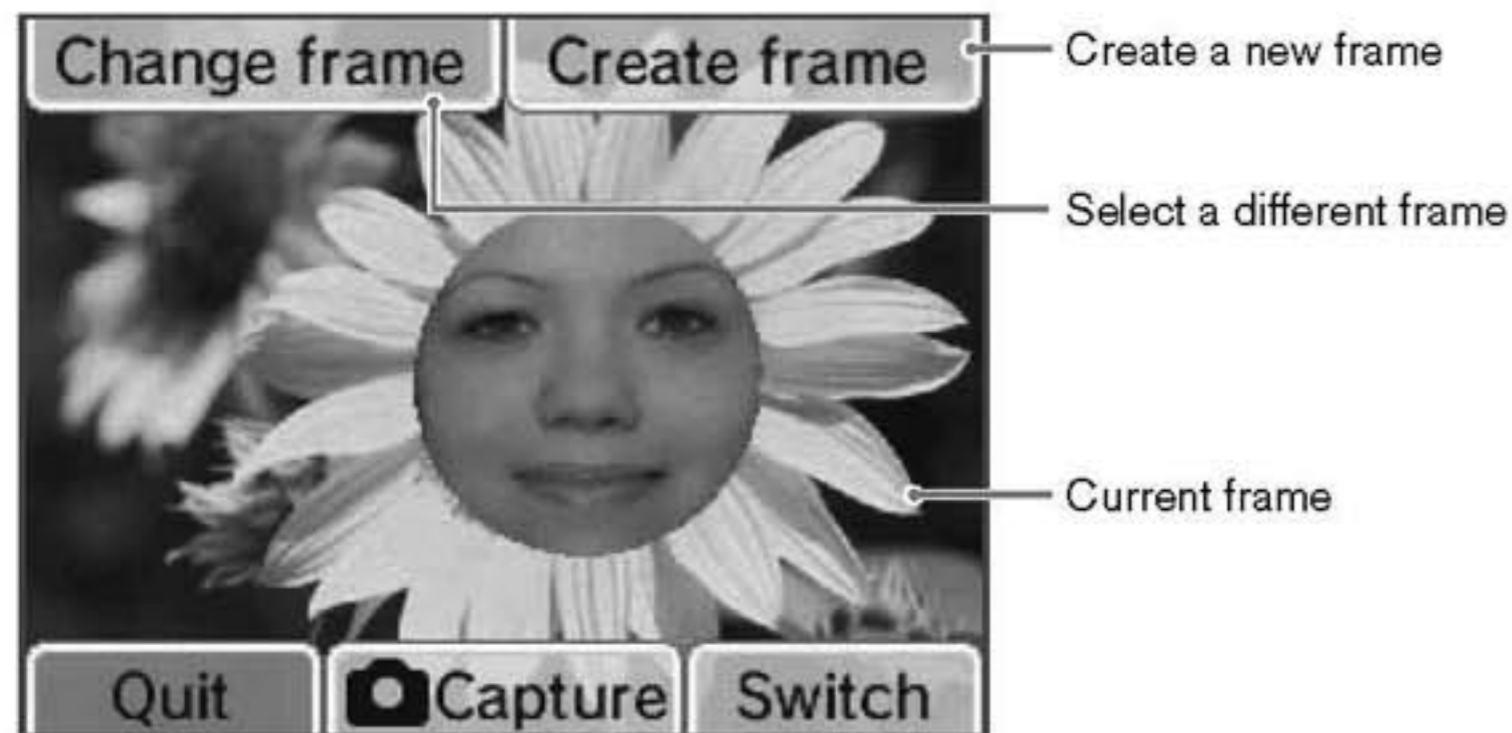

Create a new frame

Select a different frame

Current frame

### Creating Frames

- 1 Touch CREATE FRAME on the Touch Screen.



- 2 Select whether you want to take a new photo or use a photo you've already taken.

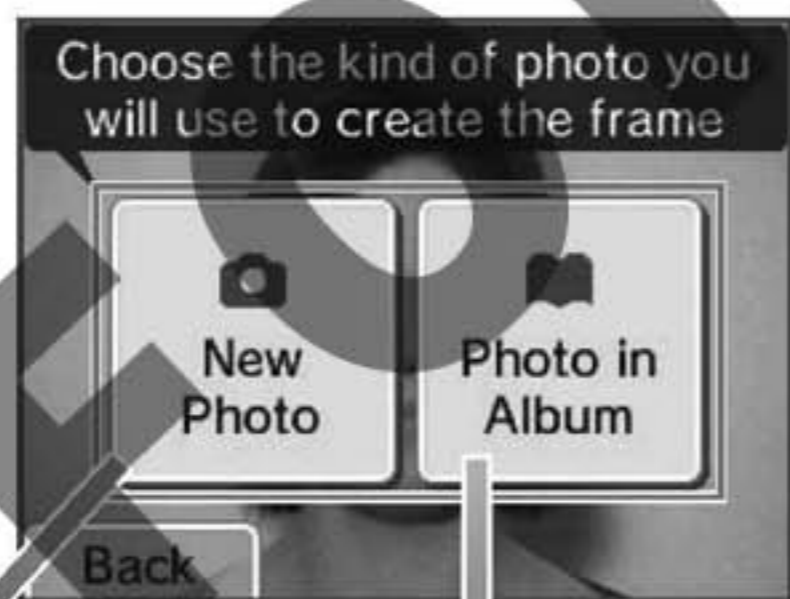

Take a new photo to use as a frame.



Select a photo from your album and touch **OK**.

- 4 Use the eraser to carve out a blank area in the photo.

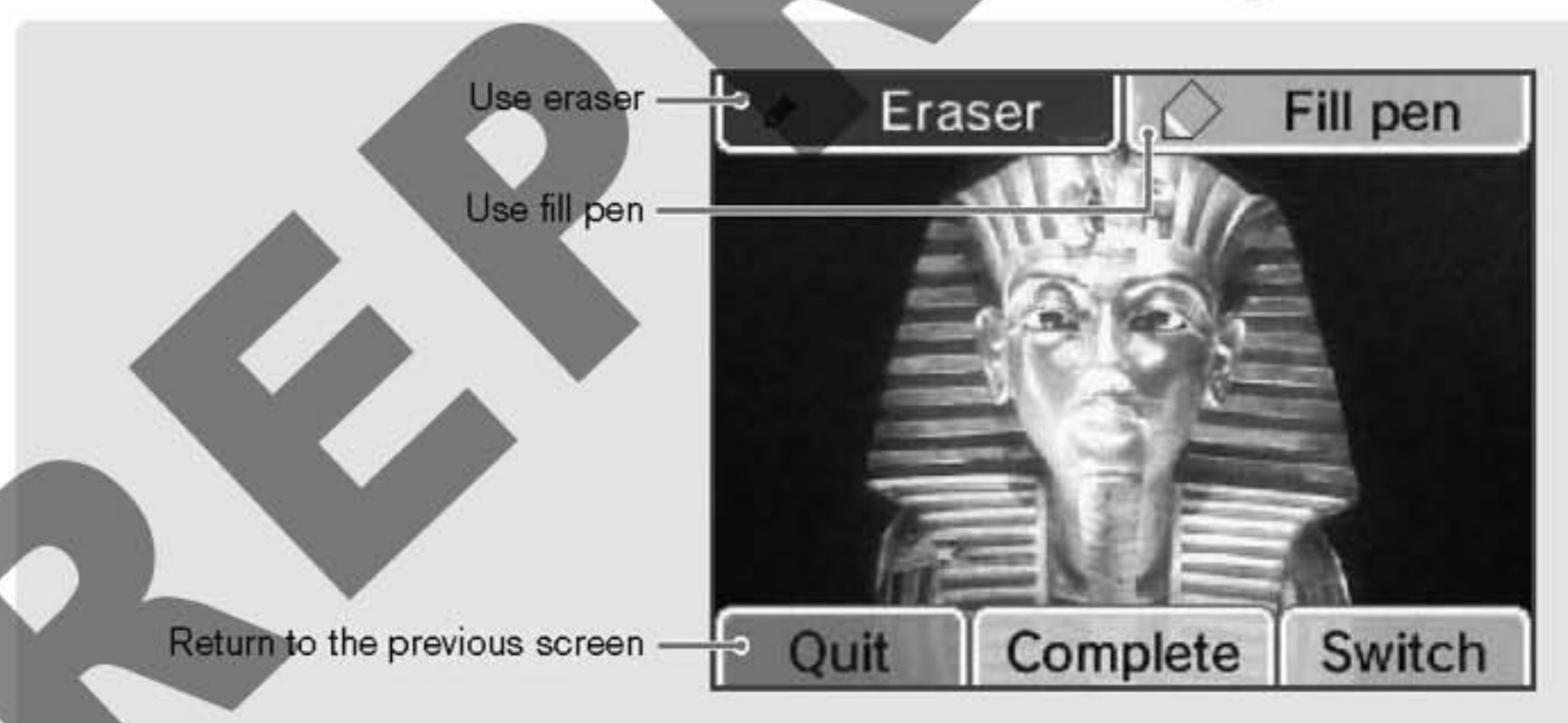

- 5 Touch **Complete** to save your frame. The completed frame is saved as frame data. You can select it by touching CHANGE FRAME.



Now, you can use the frame you just created and take a new photo with it!

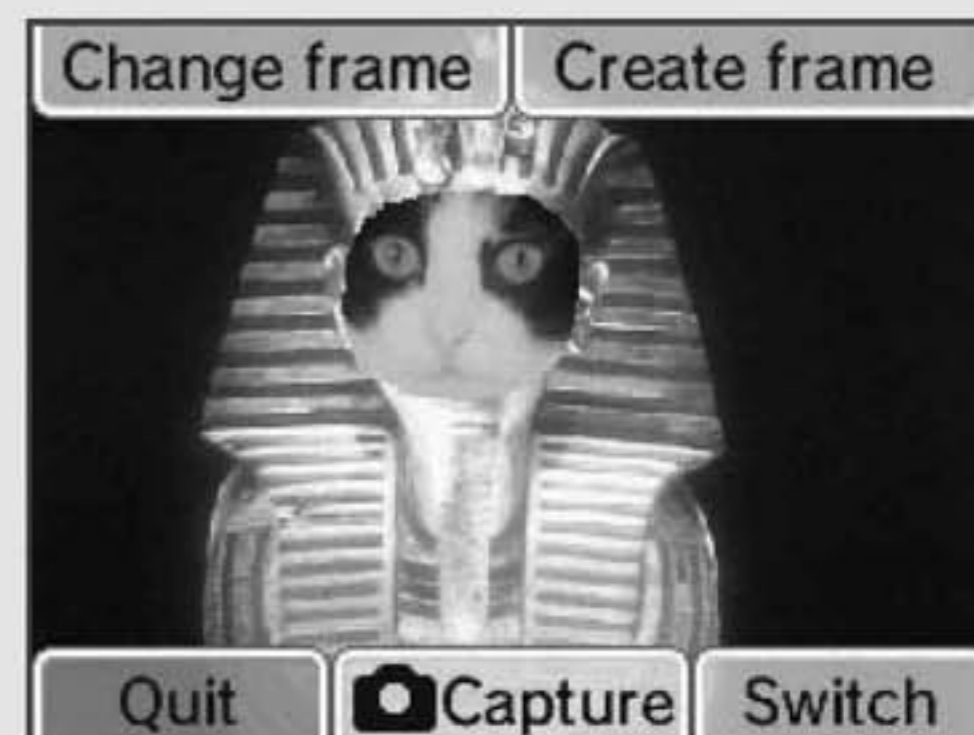

## Viewing the Album

Select ALBUM from the **Nintendo DSi Camera Menu** to view thumbnails of your photos. You can view, edit or delete any of the photos you have taken.

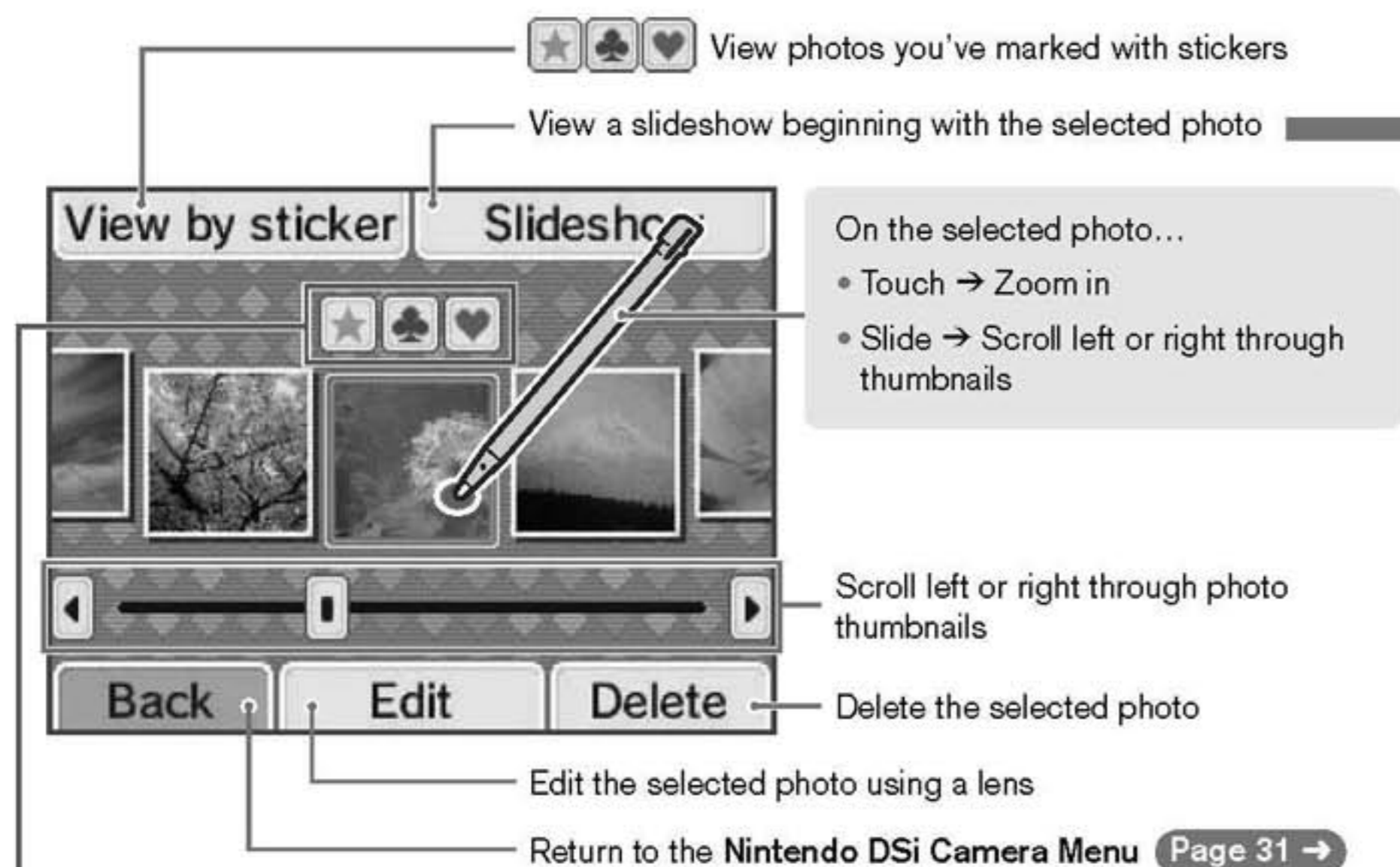

### Stickers

You can apply a variety of stickers (★ ♣ ♥) to your photos to help organise them.

**Note:** Photos with ★ stickers will appear on the top screen in the **Nintendo DSi Menu**. Photos captured from the **Camera Mode** in **Nintendo DSi Menu** will automatically receive a ★ sticker.

## Slideshow

Select SLIDESHOW from the **Album Screen** to display photos one after another.

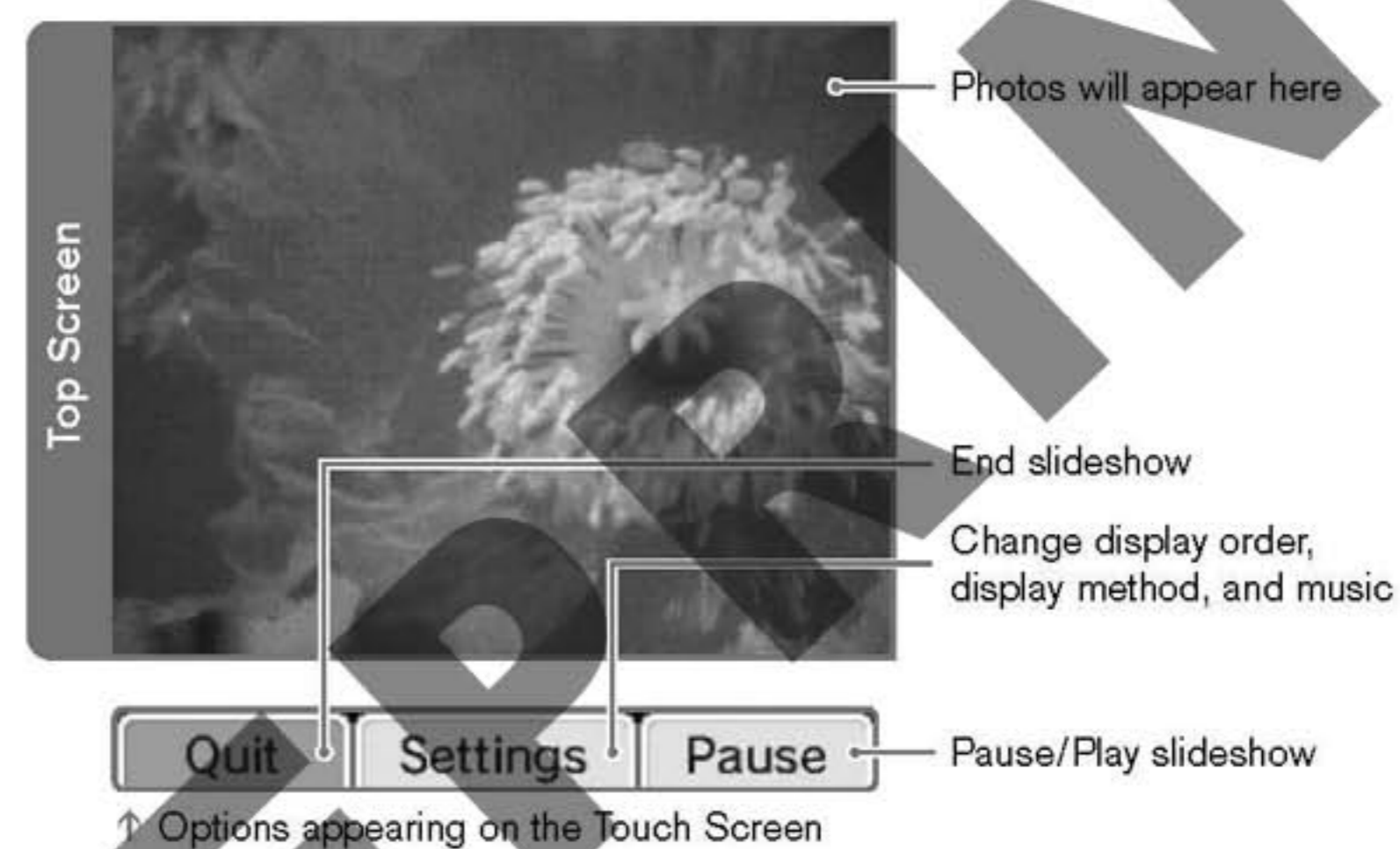

## Slideshow Settings

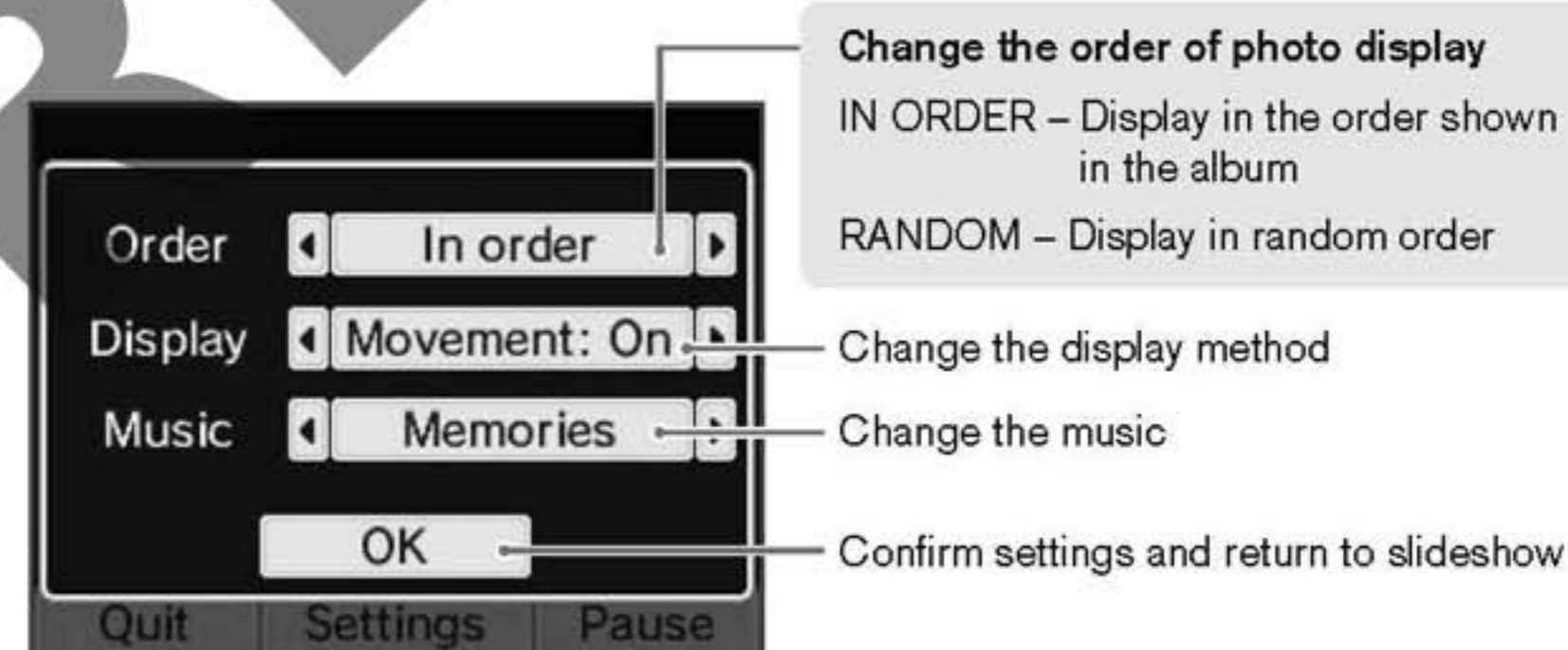

## About the Thumbnails

- Photos are displayed from left to right in order of oldest to newest. When using VIEW BY STICKER, photos are displayed from left to right in the order in which stickers were applied.
- Photos with file formats that cannot be displayed will have a ? icon.
- If you have a lot of photos, it might take a while for all of the thumbnails to appear.

## Displaying Photos in the Nintendo DSi Menu

Only photos labelled with a ★ sticker will appear on the top screen of the **Nintendo DSi Menu**. Apply a ★ sticker to any photos you want to display in the **Nintendo DSi Menu**. Remove ★ stickers from any photos you do not want to appear in the **Nintendo DSi Menu**.

## Photo Data

- Only photos taken with a Nintendo DSi system can be displayed or edited in Nintendo DSi Camera. Photos taken with a digital camera or mobile phone cannot be displayed, nor can those photos which have been taken on a Nintendo DSi system and copied to an SD Card, if the file name, position of the file on the SD Card or content of the file have been altered on a computer or other device.
- Photos taken on a Nintendo DSi system contain thumbnail data and photo data. Editing the photos on a computer or other device does not guarantee that the thumbnail data will reflect those changes. As a result, third parties may be able to view unedited thumbnail data if altered photos are uploaded to the internet. Photos modified on a Nintendo DSi system reflect those changes in their thumbnails.



Select **OPTIONS** from the **Nintendo DSi Camera Menu** to exchange, copy or delete photos or frames. You can also delete memos here.

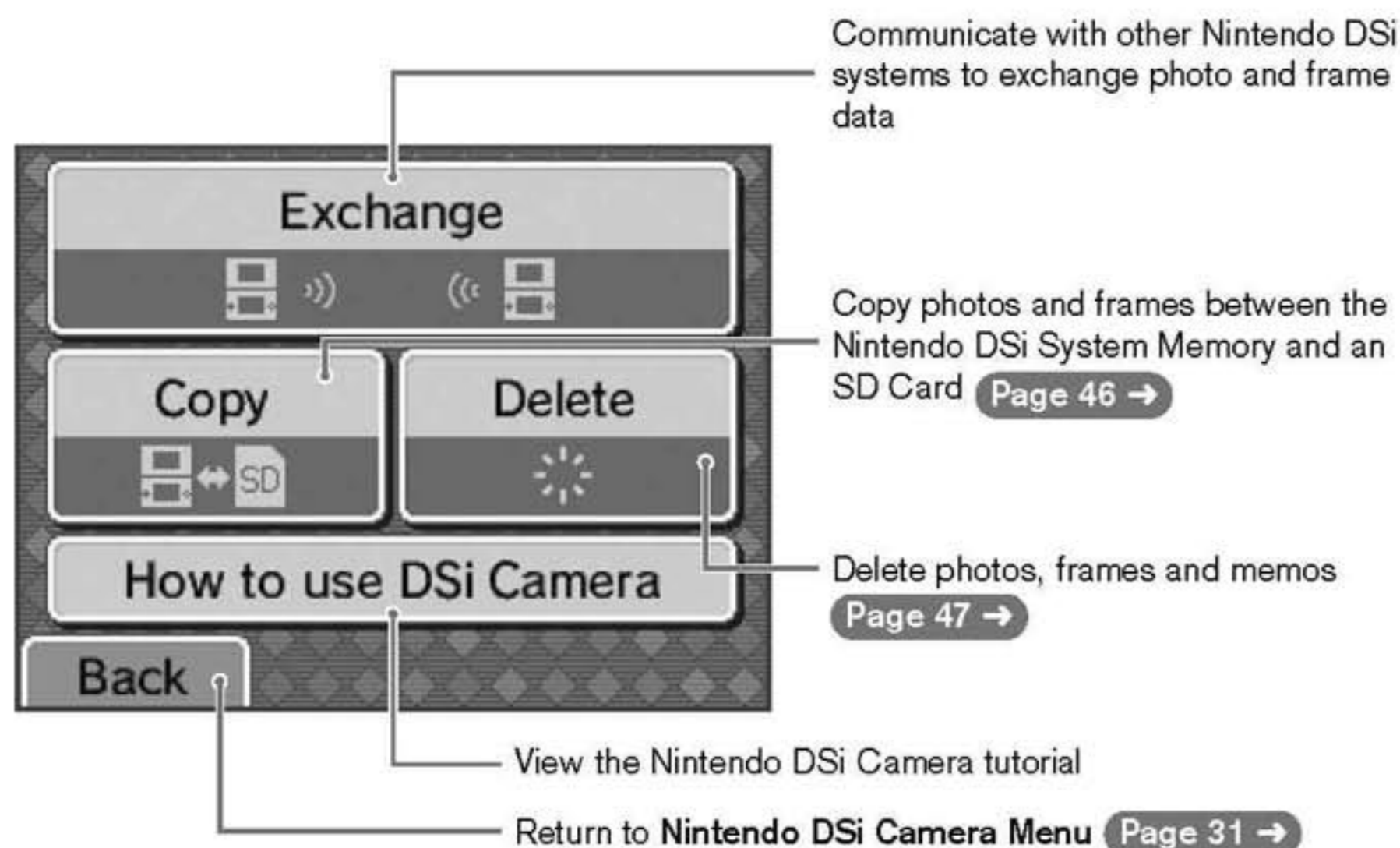

### Information about use of Photo and Frame Exchange

Please pay attention to the following regarding the exchange of photos and frames.

- Photos and frames sent using DS Wireless Communications in the Nintendo DSi system may be modified and resent by the recipient or other third parties.
- Photos and frames that have been passed on to other users cannot be deleted from the recipient's system by the sender or restricted in use/distribution.
- Please pay sufficient attention to image rights, privacy rights and copyrights when sending photos and frames.

### Exchanging Photos / Frames

Communicate with other Nintendo DSi systems to exchange photos or frames.

#### Controls for Sender

- 1 Touch **SEND**.



- 2 Wait for the recipient(s).

- 3 Select recipients **1** then touch **START** **2**.



You can send to up to three Nintendo DSi systems at once.

- 4 Select where your photo (or frame) is located (either **SYSTEM** for System Memory or **SD CARD**).

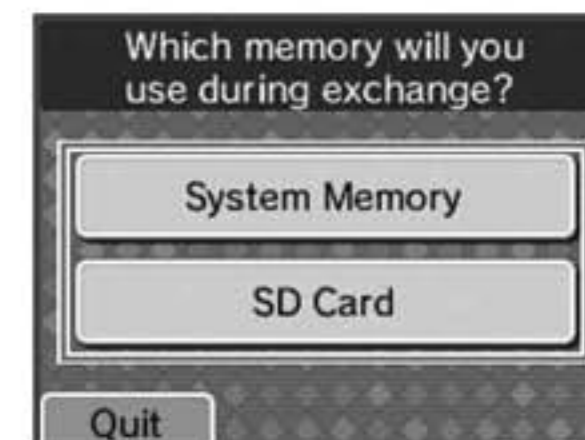

- 5 Select what you want to send.



- 6 Select the photo (or frame) to send, then touch **SEND**.

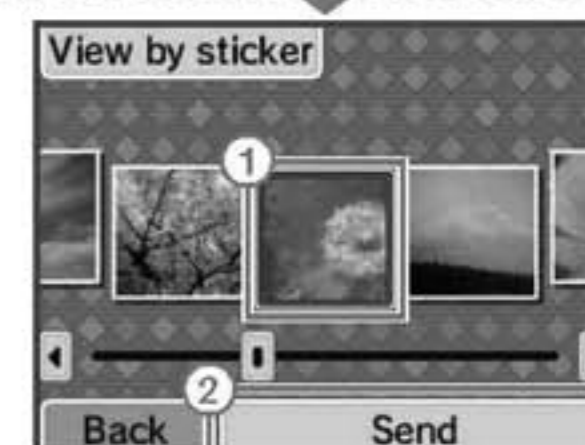

- 7 Select **YES** when you see the confirmation message.

#### Controls for Recipient

- 1 Touch **RECEIVE**.

- 2 Touch a location to save to.



- 3 Touch who you want to receive data from.



Controls for receiving are finished at this stage.

## Copying Photos/Frames

You can copy saved photos and frames from your Nintendo DSi system to an SD Card or vice versa.

- 1 Select where you want to copy from.

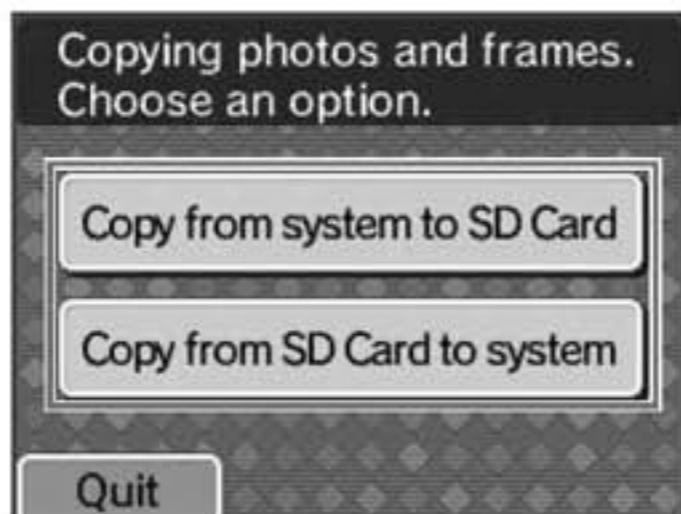

- 2 Select the kind of data you want to copy.



- 3 Select the photos or frames you want to copy.

**Note:** In this screen, the user has selected PHOTOS.



If you select COPY INDIVIDUALLY, you can select a specific photo or frame from the photo album.

**Note:** In this screen, the user has selected PHOTOS.

Select the photo or frame ① and then touch COPY ②.

## Deleting Photos/Frames/Memos

You can delete photos, frames and memos saved in the System Memory or on an SD Card.

- 1 Select where you want to delete from.



- 2 Select the data you want to delete.

**Note:** In this screen, the user has selected to delete from the System Memory. Since memos can only be saved in the System Memory, the MEMOS option will only appear on this screen.



If you select to delete all memos, select YES on the Confirmation Screen.



- 3 Select which photos or frames you want to delete.

**Note:** In this screen, the user has selected PHOTOS.

**WARNING!**

If you select ALL PHOTOS, sticker photos or ALL FRAMES, you can quit during the deletion process, but some of the photos or of the frames may still be erased.

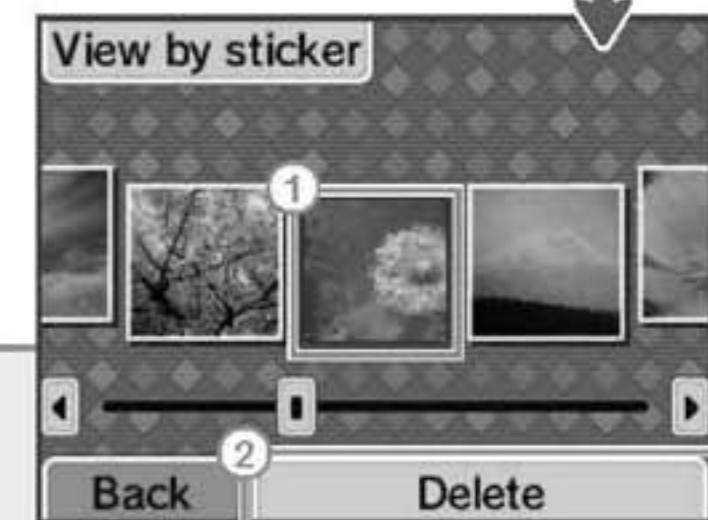

If you select DELETE INDIVIDUALLY, you can select a specific photo or frame from the photo album.

**Note:** In this screen, the user has selected PHOTOS.

Select the photo or frame ① and then touch DELETE ②.

## Calendar

Select CALENDAR from the **Nintendo DSi Camera Menu** to access the calendar on the Touch Screen.

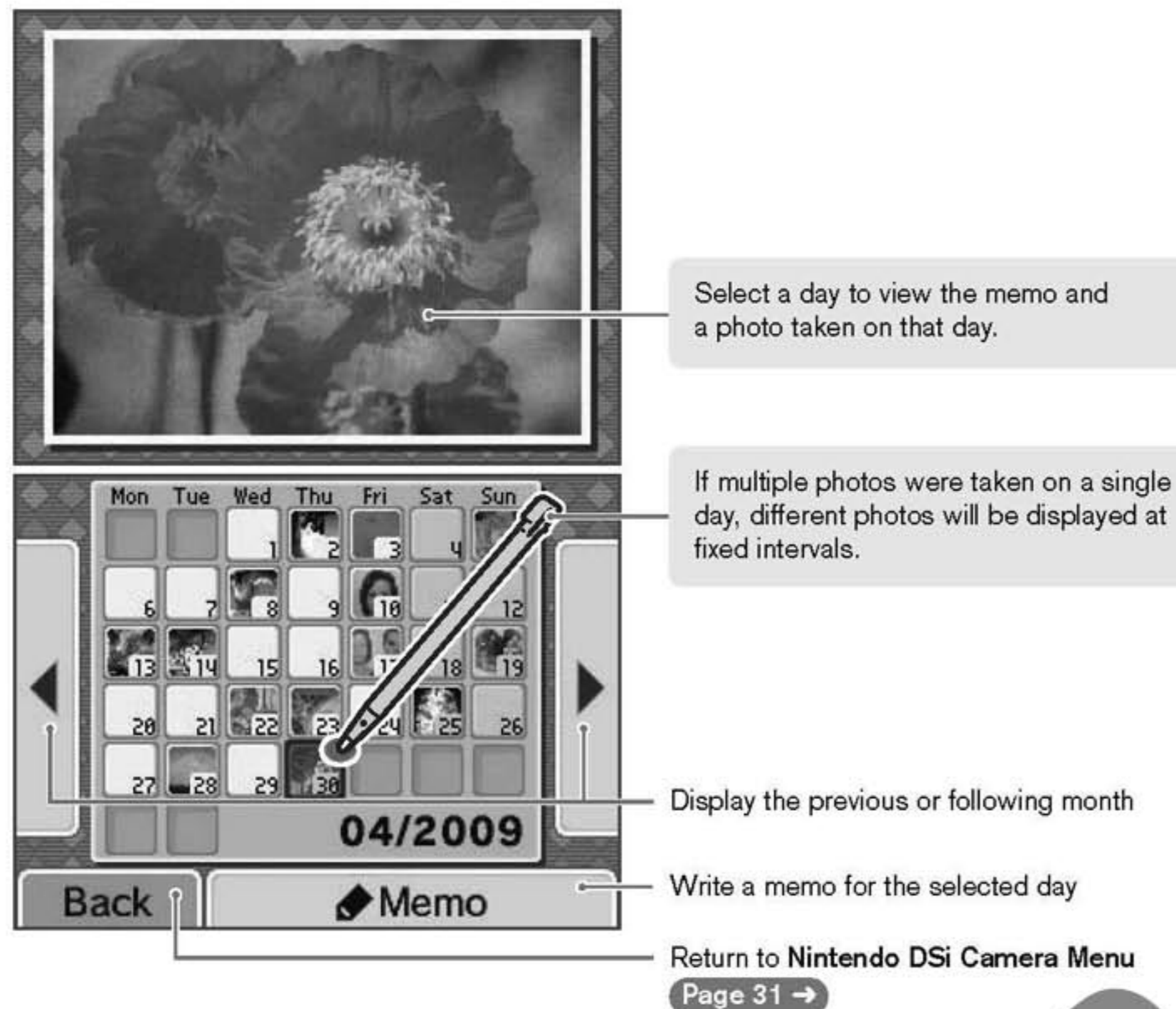

## Writing Memos

You can write a handwritten memo for each day, whether it's a note about a special event or a reminder about when those photos were taken. All memos are saved in the System Memory.

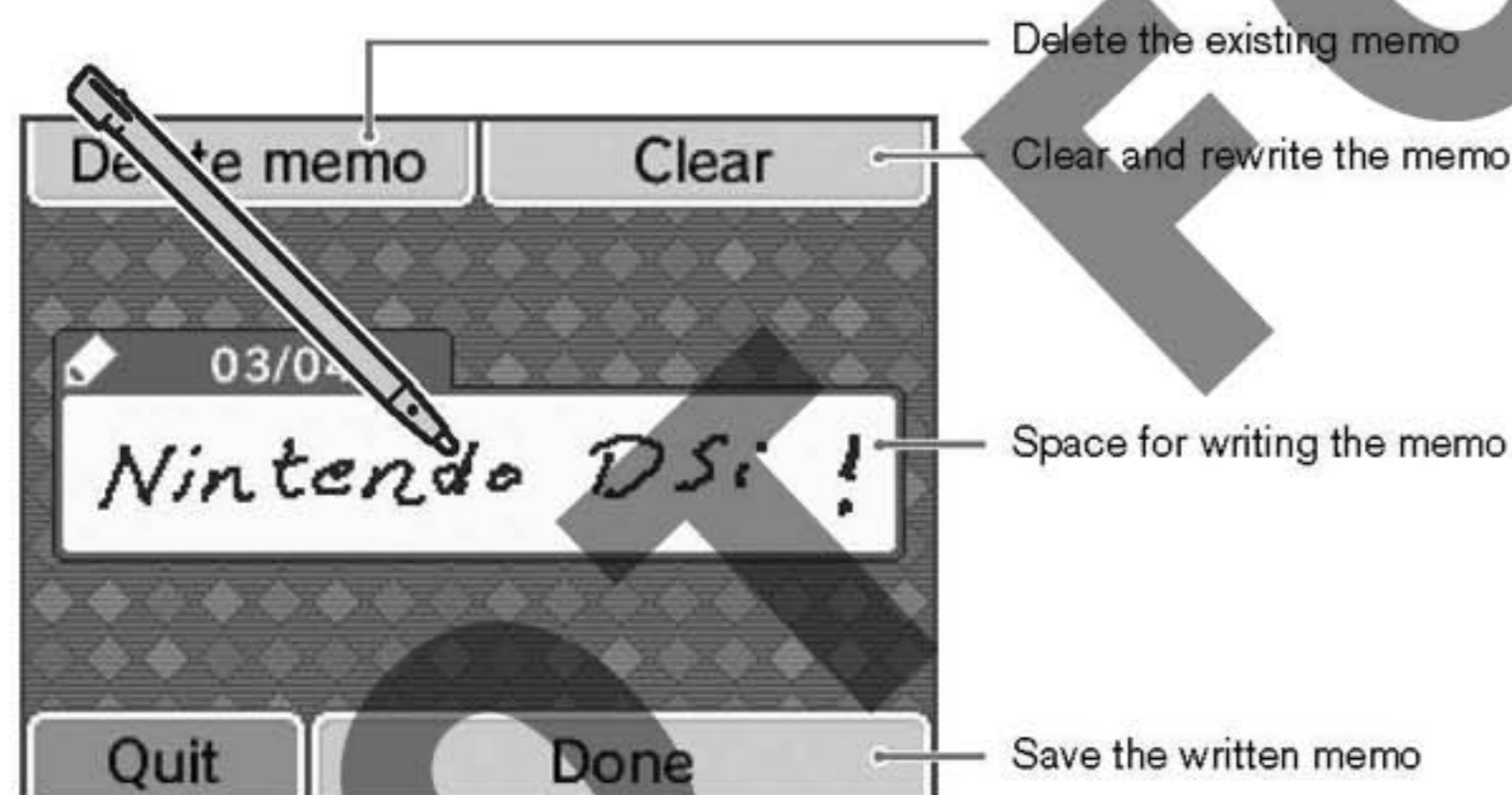

## Nintendo DSi Sound

With Nintendo DSi Sound, you can record sounds using the microphone and then play with them to create new sounds. You can also play with music saved on an SD Card.



## Starting Nintendo DSi Sound

When you start Nintendo DSi Sound, you will see a sound wave on the top screen and selectable options on the lower screen. Touch an option to begin playing with sound.

## Nintendo DSi Sound Menu

Record sounds with the microphone and play with them [Page 50 →](#)

Play with music files\* saved on an SD Card [Page 55 →](#)

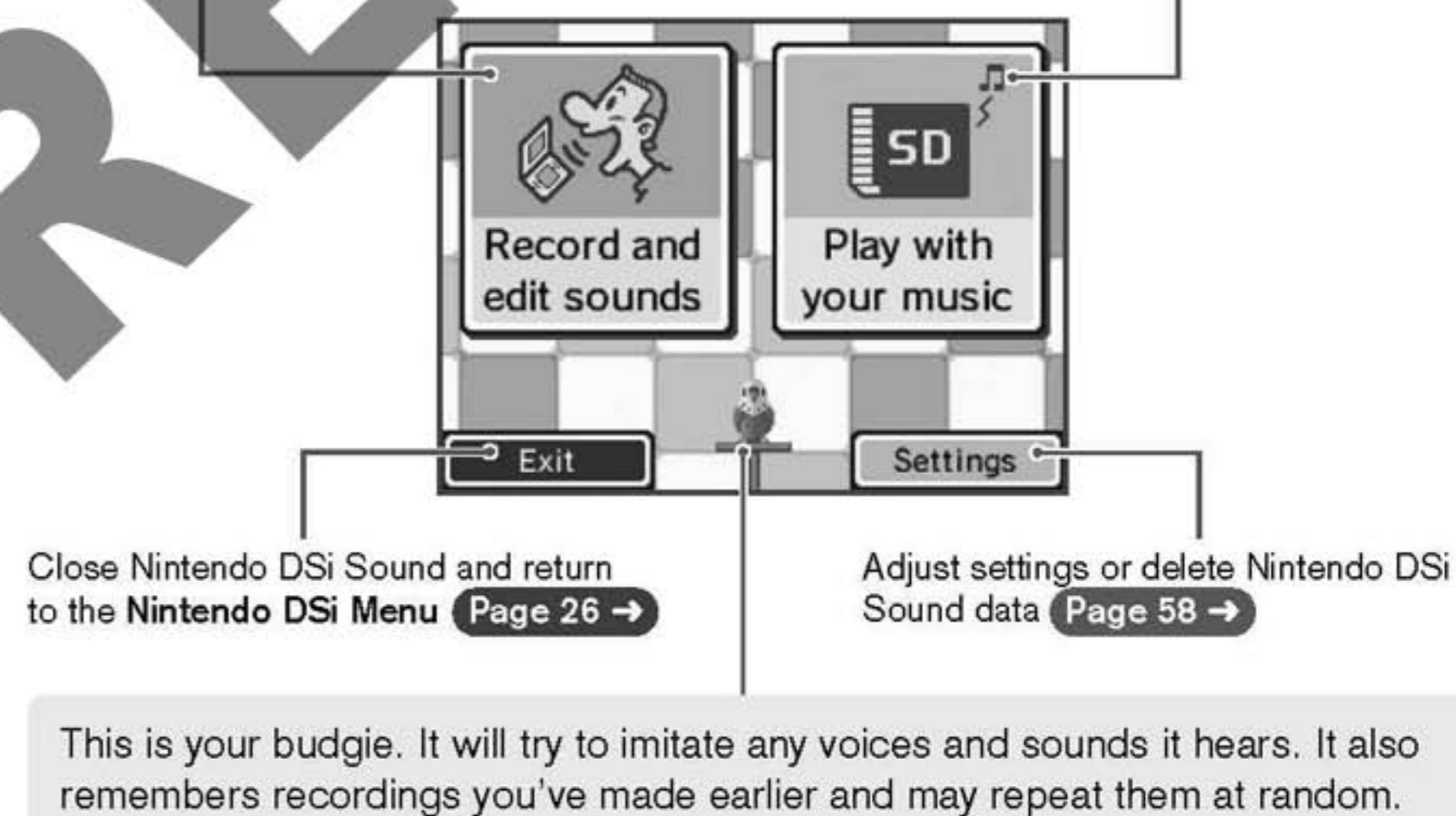

## \*Playable File Formats

The following file formats can be played in Nintendo DSi Sound:

AAC files with .m4a, .mp4 or .3gp filename extensions  
Bitrate: 16 kbps – 320 kbps  
Sampling rate: 32kHz – 48kHz

**Note:** MP3 files are not supported.

For information on how to save music to an SD Card, see [Page 58 →](#)



## Recording and Playing with Sounds

Touch RECORD AND EDIT SOUNDS from the **Nintendo DSi Sound Menu**.

**Note:** Sound data will be saved in the Nintendo DSi System Memory. No data will be written to or read from your SD card.

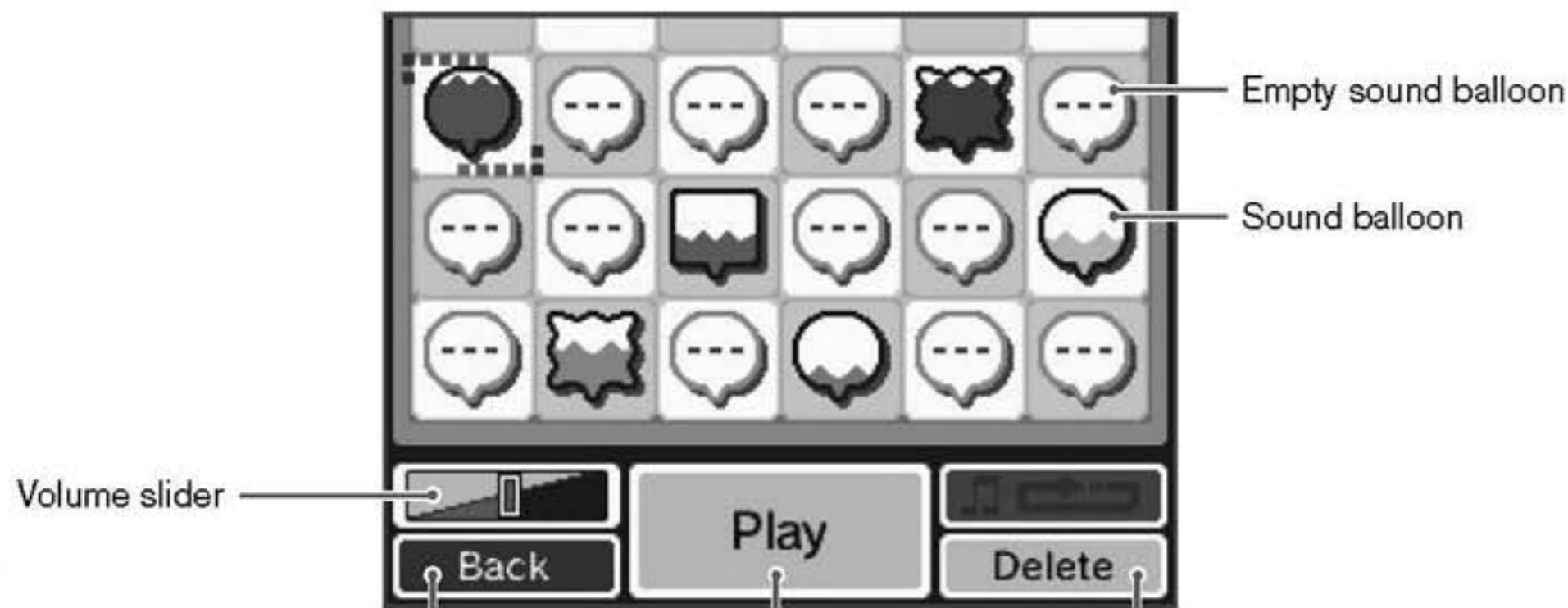

Return to the Nintendo DSi Sound Menu  
Page 49 →

Delete the selected sound balloon's data

**While an empty balloon is selected**  
Record Use the microphone to record a sound. Each balloon can hold up to ten seconds of sound.

**While a balloon with data is selected**  
Play Play with your sounds by changing the playback speed, applying filters, etc.  
Page 52 →

### Moving Data into Different Locations

1 Touch the balloon you want to move, and then slide it to a different location and release it.

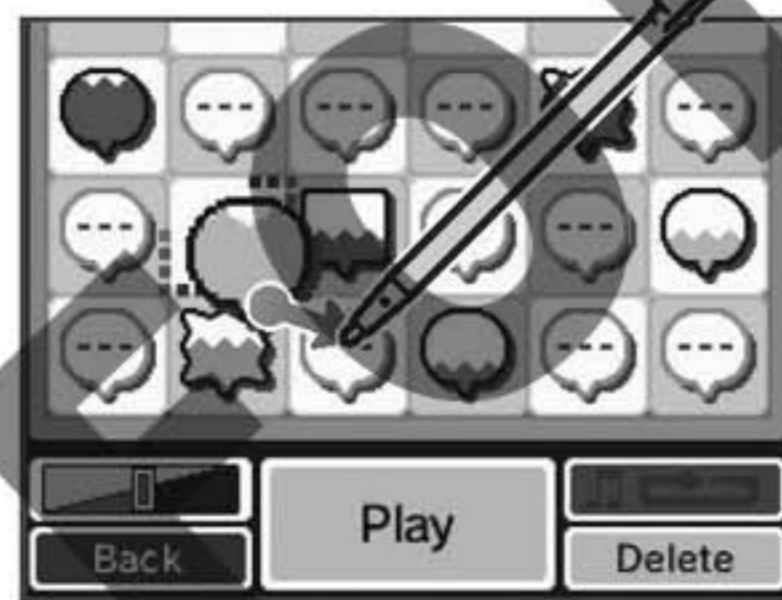

2 The two balloons will swap locations.

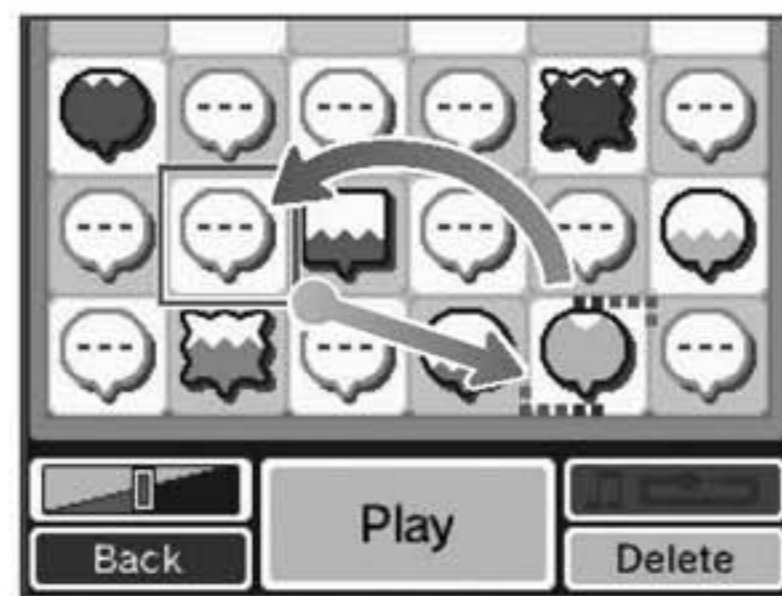

### Recording

1 First, touch an empty balloon ①, then touch RECORD ②.



2 Touch ● to begin recording. If the microphone detects a loud enough sound, it will begin recording automatically.



3 Once you've finished recording, touch OK. The sound balloon will be given the colour you touch.

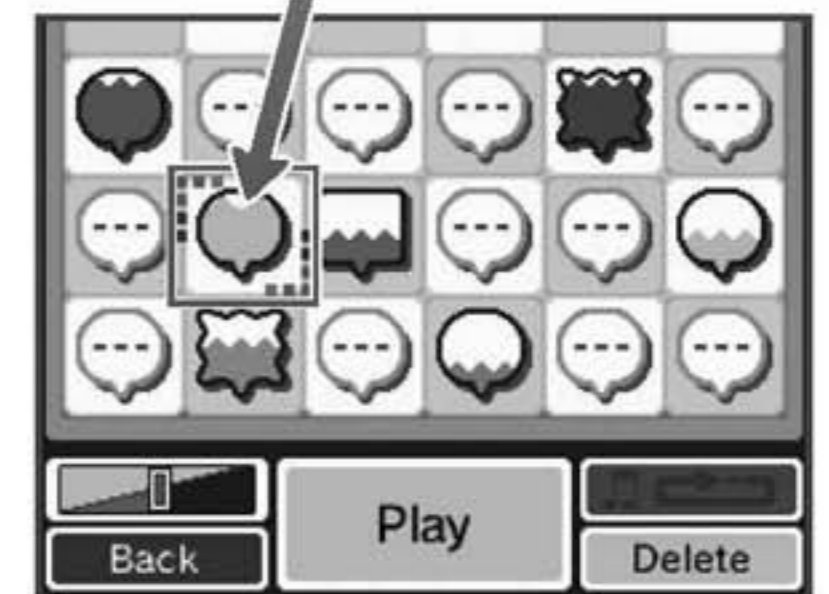
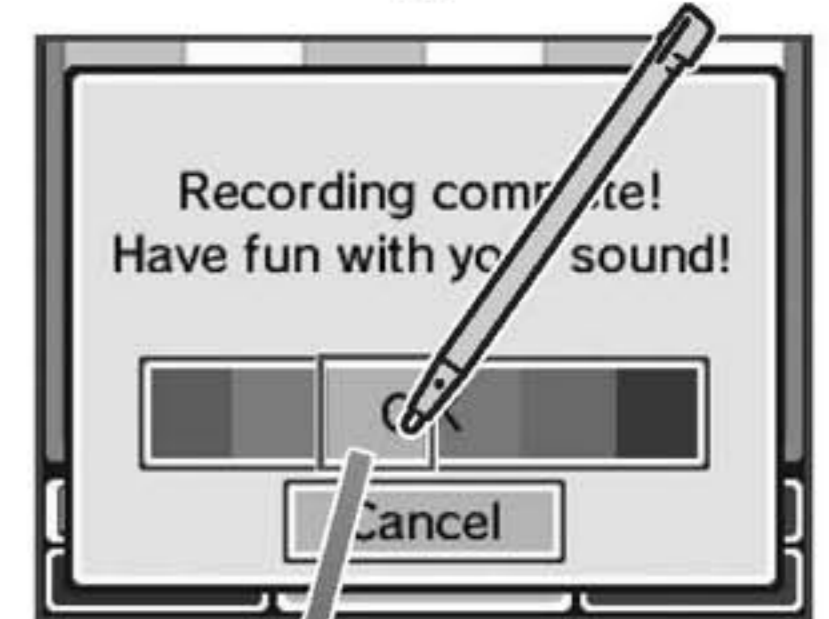

## Playing with Sound

- 1 First, touch the sound balloon you want to play with ①, then touch PLAY ②.

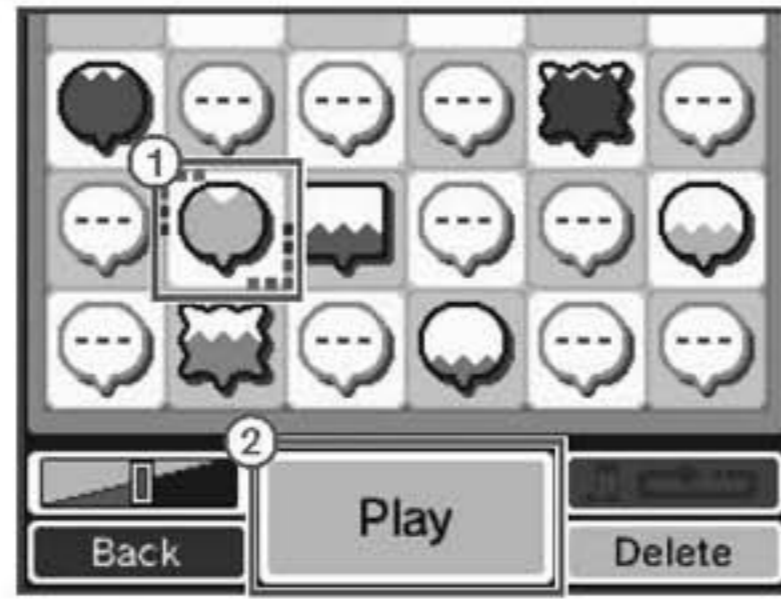

- 2 Change the sound however you like.

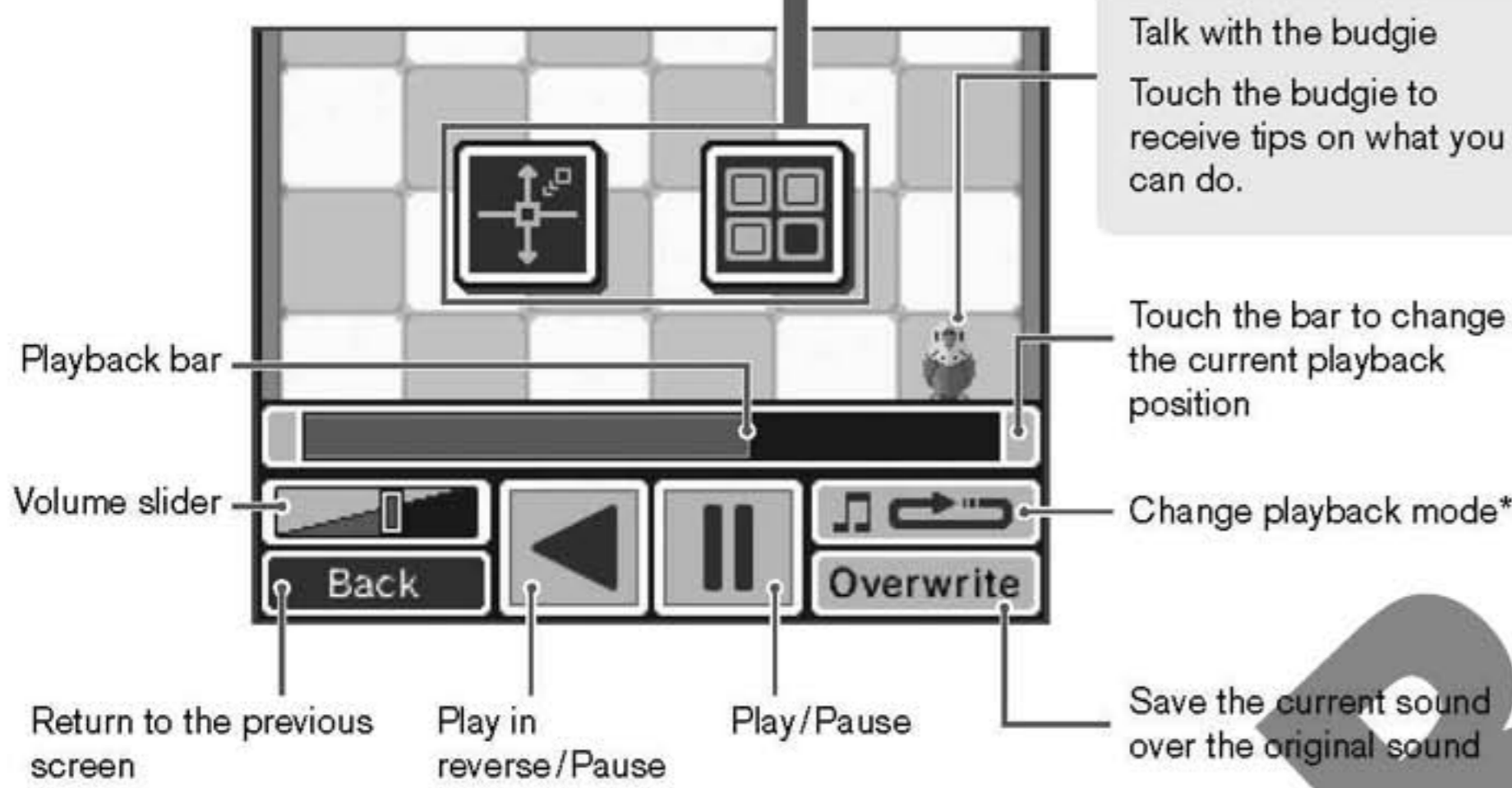

### \*Playback Modes

- Repeat the current sound.
- Play all sounds in order, then repeat from the beginning.
- Play the current sound once.
- Random play.
- Play the current sound between points A and B set by the user. Slide points A and B back and forth to adjust them.

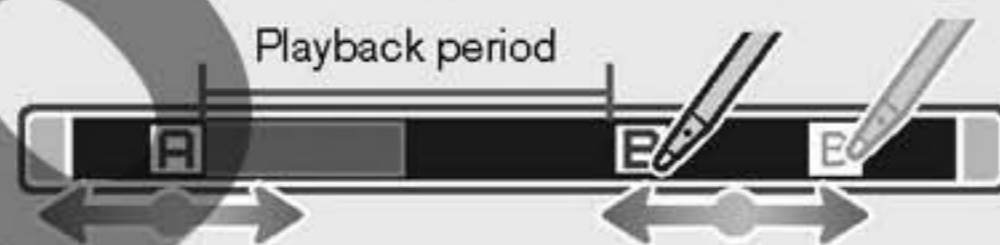

### Changing Playback Speed and Pitch

Touch the Touch Screen to move and alter the speed and pitch of the sound.

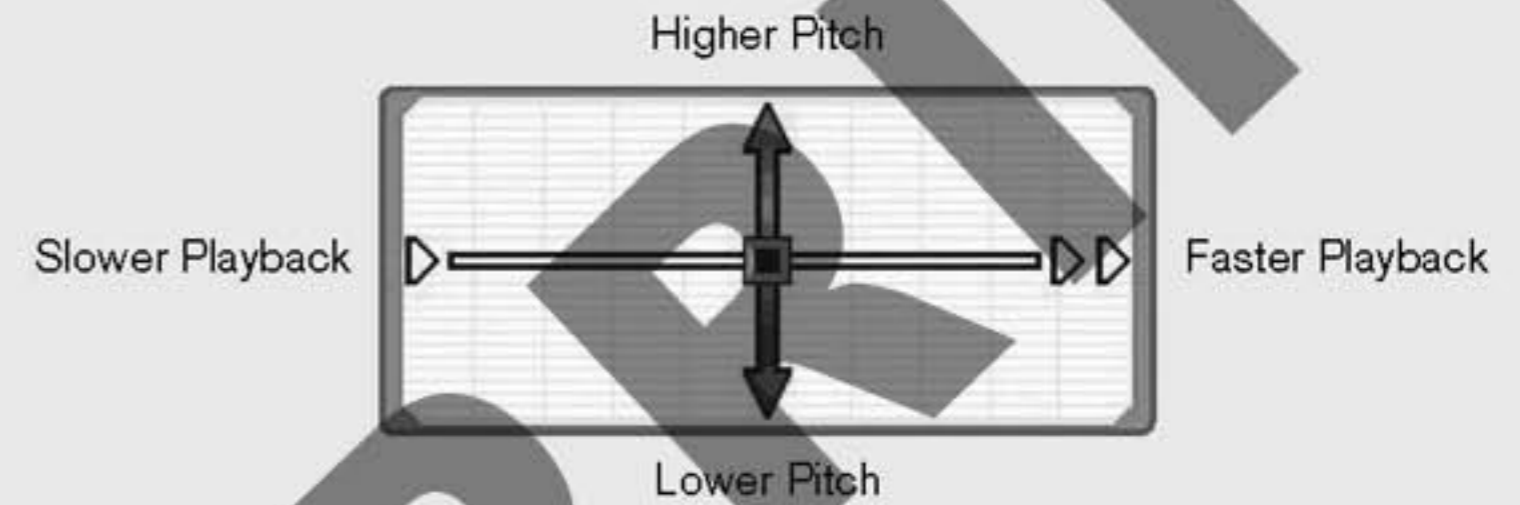

### Using Sound Filters

By touching an icon, you can apply different filters to alter your sound. Each icon has three different filters, so each time you touch one, the filter will change.

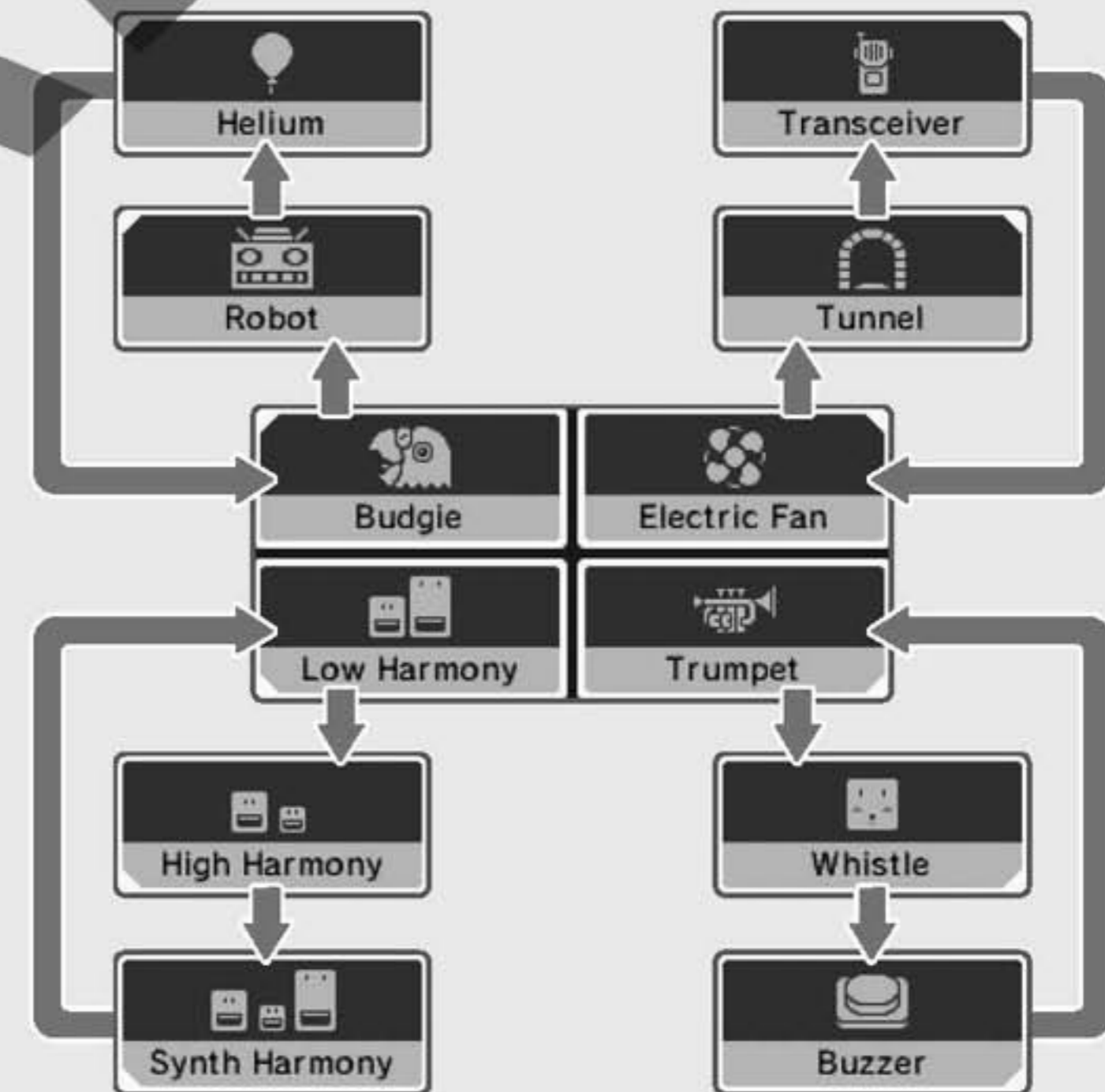

### Saving Altered Sounds

- 1 If you want to save sounds that you've changed, touch OVERWRITE.

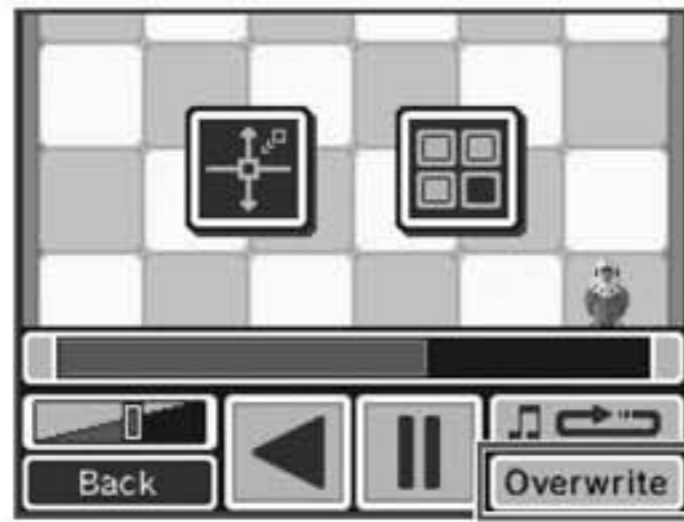

- 2 Confirm that the recording sounds the way you want it.



- 3 Touch OK. The sound balloon will be given the colour you touch.



- 4 The sound will be saved.

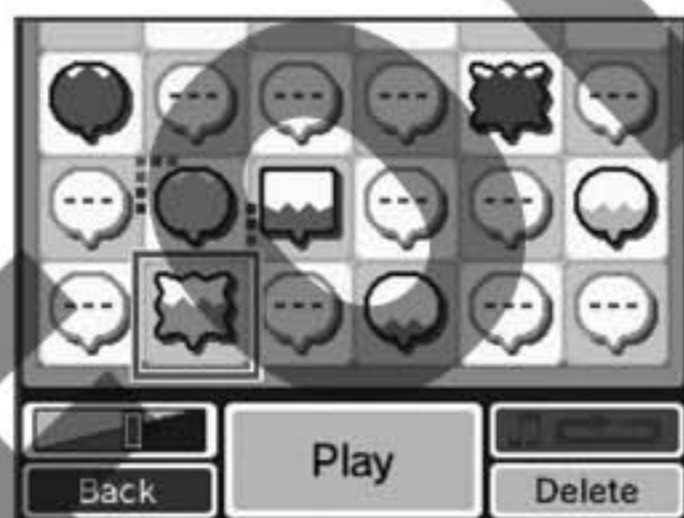

### Choose a Song to Play

- 1 First, touch a folder ①, then select OPEN ②.

Select RANDOM to listen to a song chosen automatically.

You can register songs in one of the Favourites lists, such as TOP 10 or MEMORIES.



Touch CLEAR to erase all songs from a Favourites folder.

- 2 First, touch the song you want to listen to ①, then touch LISTEN ②.



Add the currently selected song to one of the Favourites lists.

### About Folders and Files on SD Cards

- In Nintendo DSi Sound, only music files and folders containing music files on the SD Card will be displayed. A maximum of 1,000 folders can be displayed.
- If multiple folders on the SD Card have the same name, those song files will all be displayed in one folder with that name.
- Up to 3,000 song files can be displayed.
- If there are more than 100 song files in a single folder, only the first 100 will be displayed.
- Folders and files more than eight levels deep cannot be displayed.
- No matter where the folders are located, they will be displayed in alphanumeric order.

## Playing with Music Files

Talk with the budgie  
Touch the budgie to receive tips on what you can do.

Change the visualisation on the upper screen.

Touch the bar to change the current playback position.

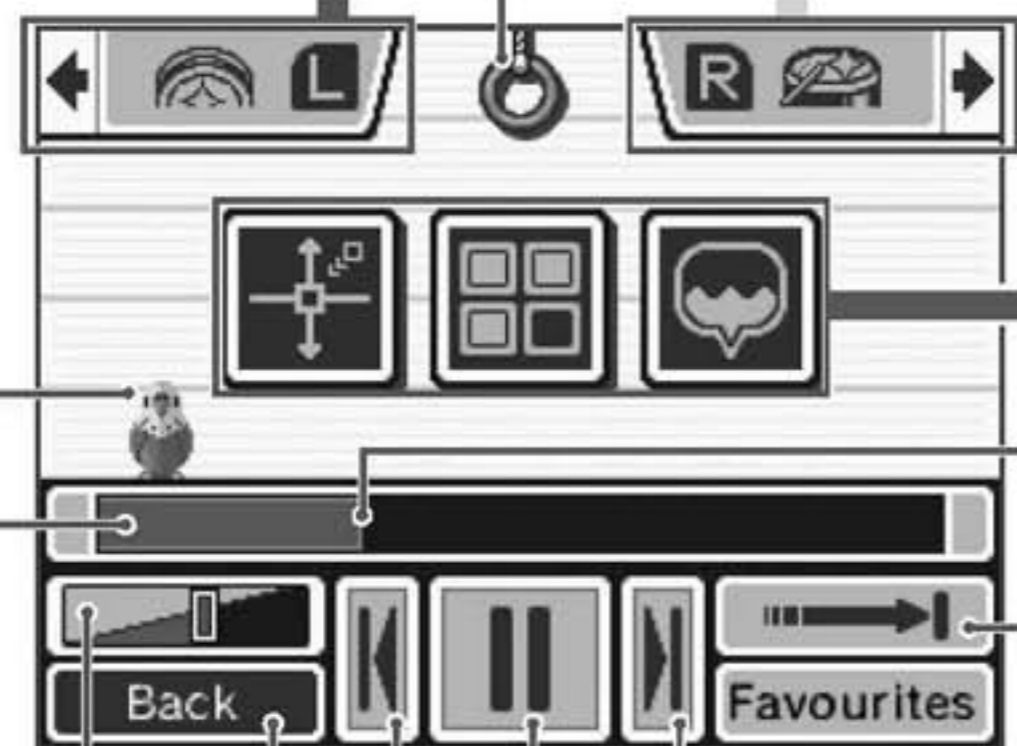

Playback position

Change playback mode\*

Volume slider

Next song

Play/Pause

Previous song

Return to File Selection Screen

### Beat Buttons

Press the L Button and R Button to add sound effects. Touch the icons on-screen to change the sound effects.

### Change the playback speed and pitch

Touch the screen to move the and adjust the playback speed and pitch.

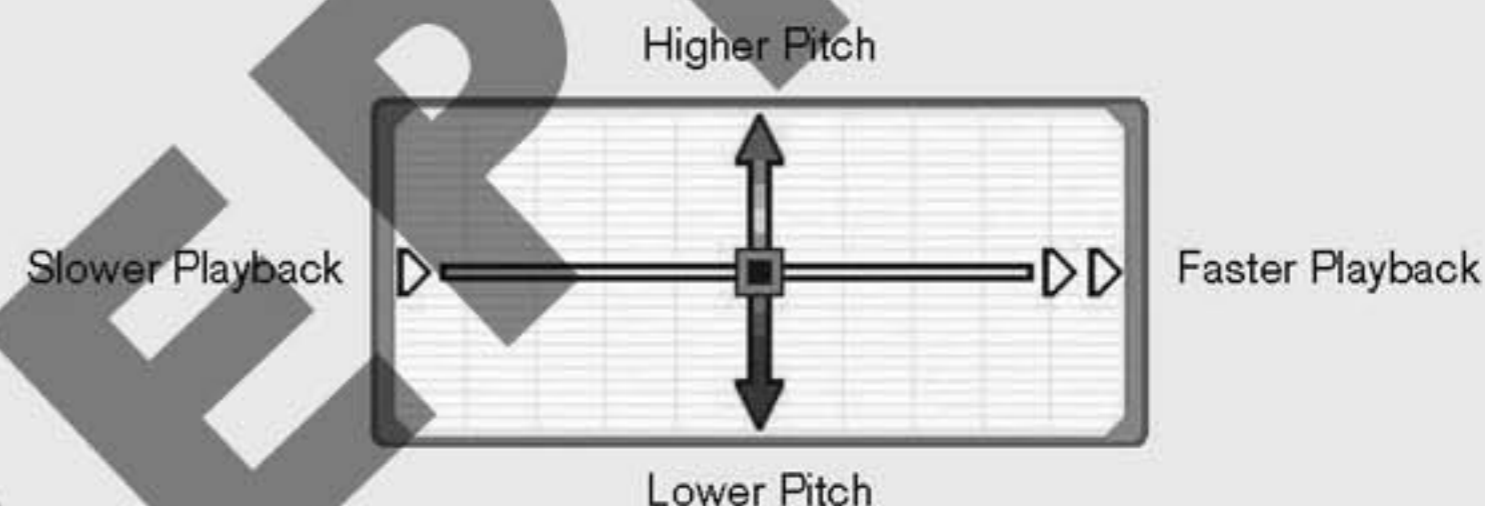

### Using filters with the music.

Touch an icon to change the filter used on the music.



Radio

Makes music sound like it's being played from an old radio.



Instrumental

Removes the vocal range from a track, leaving only the instruments. (In some songs, the vocals may not be entirely removed.)



Echo

Adds an echo effect.



8-Bit Game

Makes your music sound like an old video game!

### Layering voice recordings

Touch a sound bubble to start playing it over the music.

### \*Playback Modes



Repeat the current song.



Play the songs in the folder in order, then repeat from the beginning.



Play songs in one folder in order, then stop when finished.

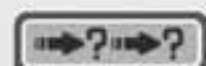

Play songs in the selected folder at random.



Play the current song between points A and B set by the user. Slide points A and B back and forth to adjust them.



## Settings

Adjust the settings for Nintendo DSi Sound or format Nintendo DSi Sound Data.

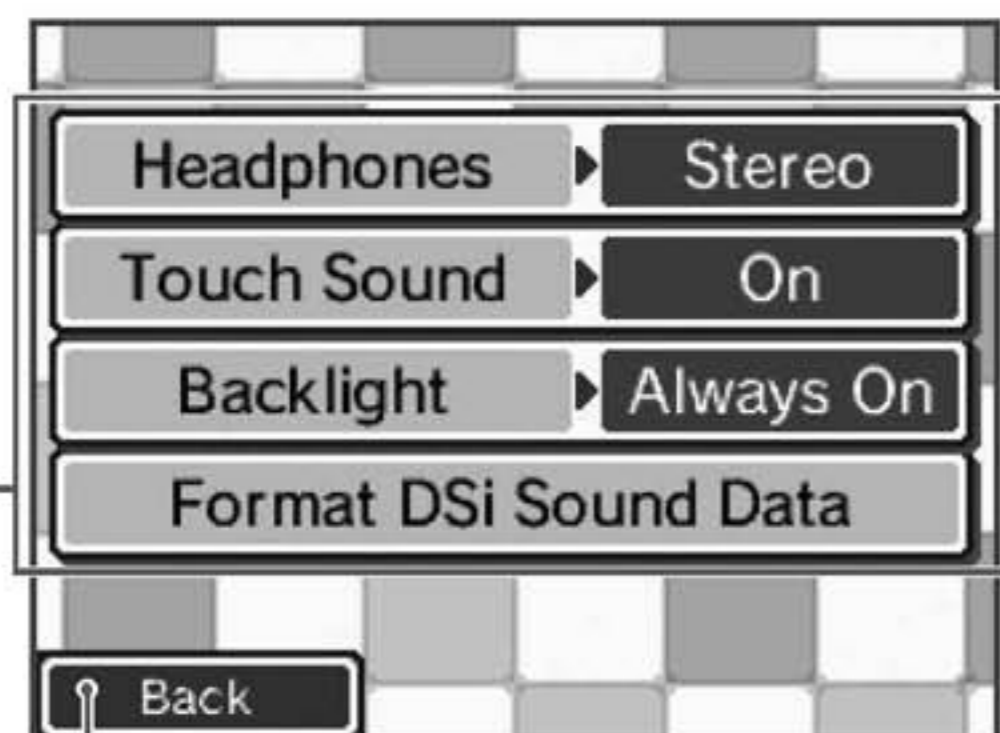

Return to the Nintendo DSi Sound Menu [Page 49 →](#)

**Headphones** ▶ Stereo Set your headphones to MONO or STEREO.

**Touch Sound** ▶ On Enable or disable Touch Screen sound effects when listening to music in PLAY WITH YOUR MUSIC.

**Backlight** ▶ Always On Set the backlight to turn off automatically when Nintendo DSi Sound is not in use.

**Format DSi Sound Data** Erase all Nintendo DSi Sound data from the Nintendo DSi System Memory. This will erase all sound files you've recorded or modified, any Favourites you've assigned to your music, and anything the budgie might have remembered.

## How do you save music files to an SD Card?

In order to play with music files, you must save music files onto an SD Card. Please follow the steps below to save music files.

- 1 Use software for your computer to copy songs from a music CD and save them in a format compatible with Nintendo DSi Sound. [Page 49 →](#)



- 2 Use the SD Card slot on your computer or a commercially-available SD Card reader/writer to place the AAC files on the SD Card.



**Note:** In the help tips for Nintendo DSi Sound, the budgie quotes lyrics from the following traditional songs: "Twinkle, Twinkle Little Star" (Jane Taylor), "Baa, Baa, Black Sheep" (Traditional) and "London Bridge Is Falling Down" (Traditional).

## Nintendo DSi Shop

You can purchase Nintendo DSi software via Nintendo DSi Shop.

Before using Nintendo DSi Shop, you must set up an internet connection. [Page 78 →](#)



## Things you'll need in order to use Nintendo DSi Shop

A broadband internet connection [Page 78 →](#)

Nintendo DSi Points

### What are Nintendo DSi Points?

You use Nintendo DSi Points to purchase Nintendo DSi software from the Nintendo DSi Shop.

One way to add Nintendo DSi Points to your account is to purchase a Nintendo Points Card and redeem those points in the Nintendo DSi Shop. Those points automatically become Nintendo DSi Points.

For more information about purchasing Nintendo Points, visit [support.nintendo.com](http://support.nintendo.com).



You can redeem Nintendo Points Cards as Nintendo DSi Points.

Purchase



Store selling Nintendo products

Redeem

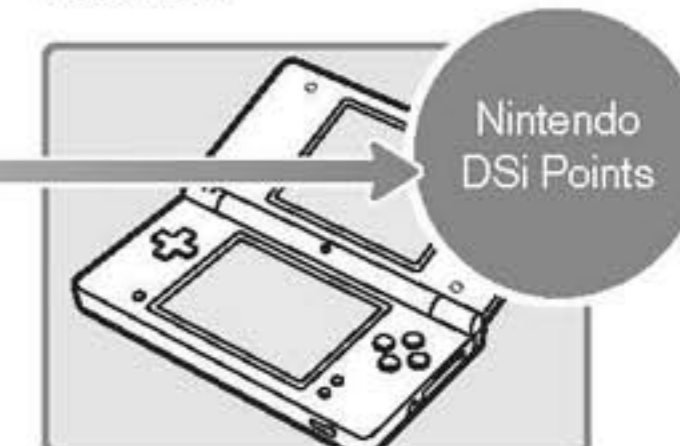

Nintendo DSi system

### What is a Nintendo Points Card?

This is a prepaid card you can redeem in the Nintendo DSi Shop as Nintendo DSi Points.



## How to Redeem Nintendo DSi Points

Use one of the following methods to get Nintendo DSi Points.

### ■ Redeem a Nintendo Points Card

- 1 Purchase a Nintendo Points Card.



- 2 Reveal the Nintendo Points number

**Note:** Reveal the number on your Nintendo Points Card by scratching off the silver area on the back of the card.



- 3 Start Nintendo DSi Shop.

↓  
Follow the on-screen instructions.



### ■ Buy Nintendo DSi Points using a Credit Card

To buy Nintendo DSi Points with a credit card, start the Nintendo DSi Shop.

↓  
Follow the on-screen instructions.

## Nintendo DSi Software and Nintendo Points Cards

- In order to connect to Nintendo DSi Shop, you will need an active broadband internet connection. The first time you connect, you will need to agree to the terms of use in order to access Nintendo DSi Shop.
- Nintendo Points Cards sold in Europe can be used only on systems purchased in Europe.
- You can redeem a maximum of 10,000 Nintendo DSi Points at a time.
- You must redeem all of the points on a Nintendo Points Card at once. You cannot divide the points between different systems or redeem them separately.
- Parents or guardians can use Parental Controls to restrict the purchase of software along age rating guidelines, as well as restricting the use of Nintendo DSi Points.
- All points and software downloads are for use only on a single Nintendo DSi system and are non-refundable and non-transferable.
- Points have no monetary value and cannot be redeemed for cash or transferred to another system.
- Software purchased with Nintendo DSi Points cannot be returned, refunded, turned into cash or transferred.
- Once Nintendo Points have been registered as Nintendo DSi Points they cannot be registered on a different Nintendo DSi system or on a Wii™ console.
- Software downloaded from the Nintendo DSi Shop is licensed to you, not sold. For more information, please refer to the terms of use that can be viewed in the System Settings.

← Page 78 →

Please see Parental Controls on [Page 72](#) → for information about Pan-European Game Information (PEGI) Video and Computer Game Software Ratings.

## DS Download Play

With DS Download Play, you can download and play certain multiplayer games with other Nintendo DS/Nintendo DS Lite/Nintendo DSi users even if you have only one copy of a game. You can also send and receive demos of certain software titles.

Nintendo DSi is equipped with RF module (802.11), which has a radiated output power of less than 10 mW e.i.r.p. and a maximum spectrum power density of less than -30 dBW/1MHz e.i.r.p. These parameters can be maintained when operated within a temperature range of 0 to 40 degrees Celsius. In accordance with this, Nintendo DSi is categorised as Class 1 equipment according to Commission Decision 2000/299/EC.



## Using DS Download Play

### Starting DS Download Play (Host)

- 1 In the **Nintendo DSi Menu**, touch the icon of a DS Download Play-compatible title.
- 2 Now follow the instructions in the Instruction Booklet of the software title you are using.



### Starting DS Download Play (Client)

- 1 Touch the DS Download Play icon in the **Nintendo DSi Menu**.
- 2 Select the panel for the software title you want to download.
- 3 Touch YES to begin downloading the software title.
- 4 Now follow the instructions in the Instruction Booklet of the software title you are using.



## PictoChat

PictoChat allows you to use your Nintendo DSi system to send and receive wireless messages and pictures from other Nintendo DSi users. PictoChat is not an internet application. You can communicate with up to 15 other Nintendo DSi users within range of your Nintendo DSi system.

You can also use PictoChat with Nintendo DS and Nintendo DS Lite users, but the controls on those systems are slightly different.

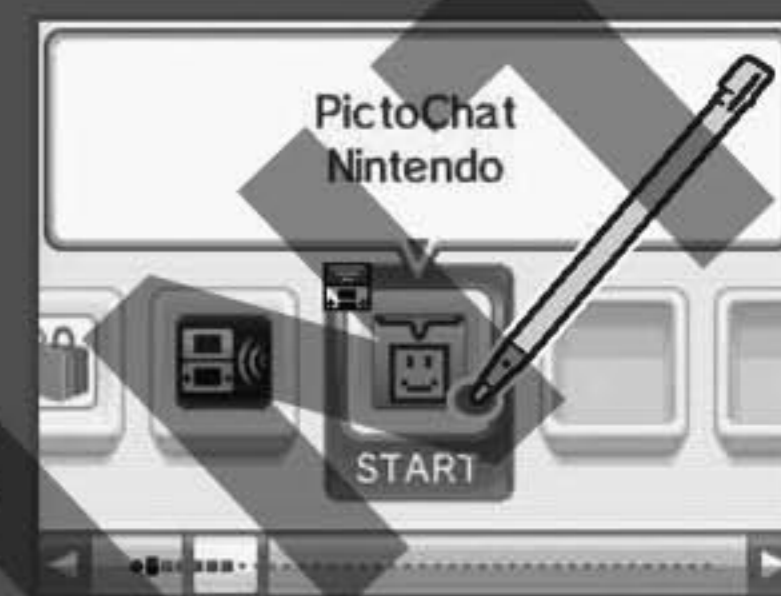

## Starting PictoChat

First, the **Chat Room Selection Screen** will appear. Select a chat room to join.



The number in each panel indicates how many people are in that chat room. If the total number of participants is already at maximum (16/16), you cannot join that chat room.

Close PictoChat and return to the **Nintendo DSi Menu**.

**Page 26** →

- Parents or guardians can restrict the use of PictoChat by using Parental Controls.

Please see Parental Controls on **Page 72** → for more information.

Upper Screen

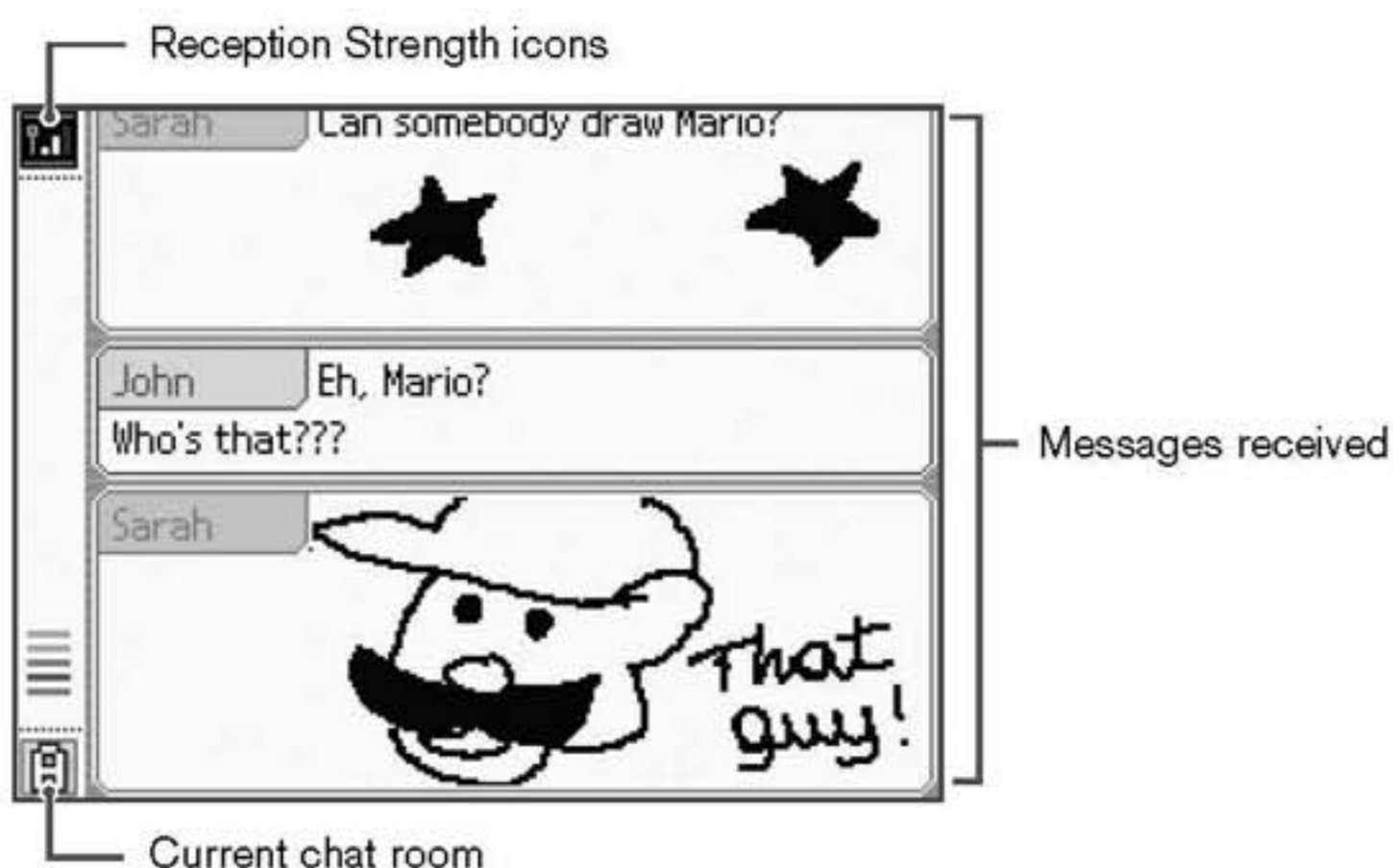

Lower Screen

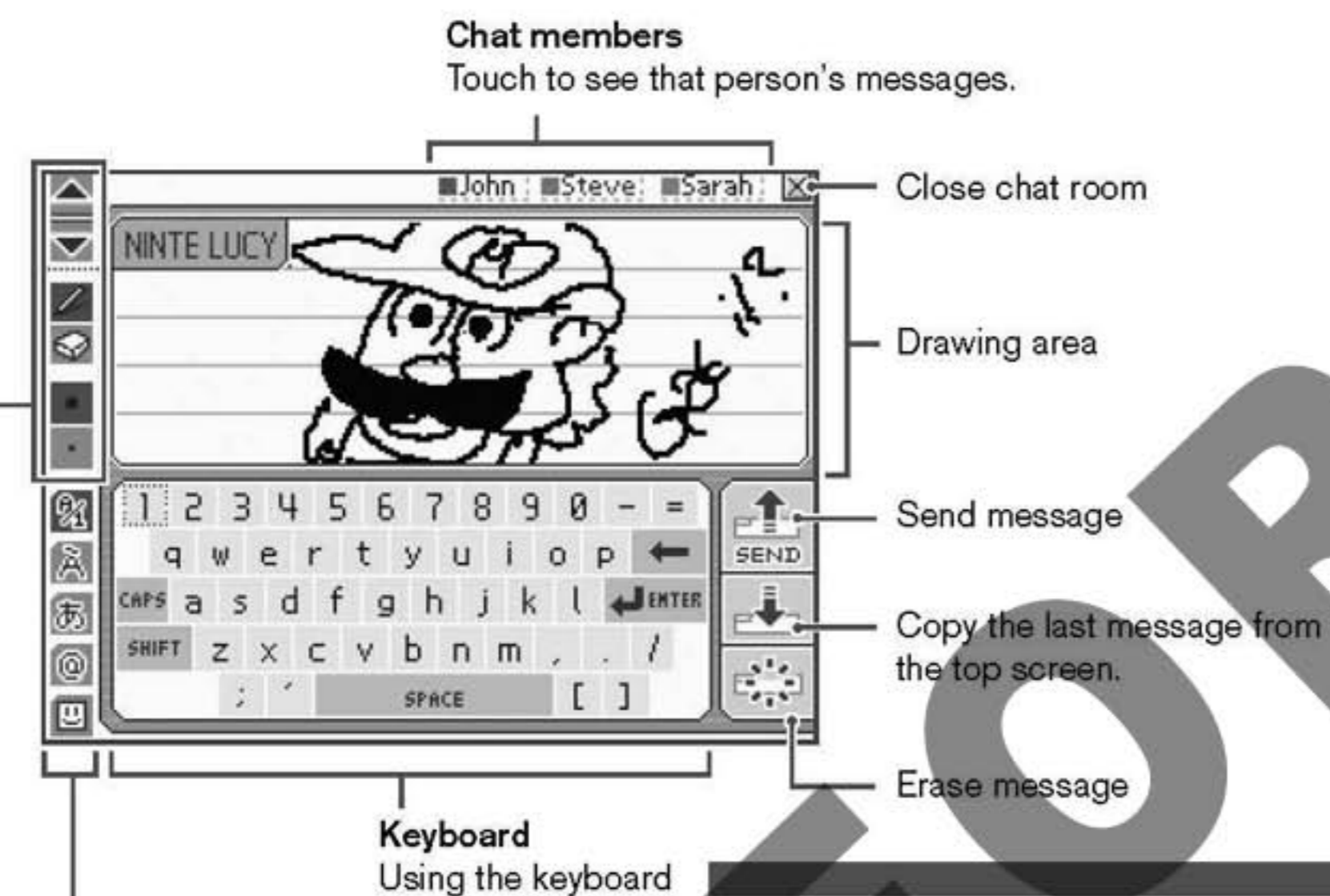

Keyboard styles:

- [A1] Alphanumeric
- [A] International
- [あ] Japanese hiragana, katakana
- [@] Symbols
- [絵] Pictures

**New function!**

Touch the icon to change between a black pen and a rainbow pen.

- [Up/Down arrows] Scroll the top screen
- [Pen icon] Pen tool (Write and draw)
- [Eraser icon] Eraser tool (Erase letters or pictures)
- [Pen/Eraser Thickness icon] Pen/Eraser Thickness (use to change the thickness of the pen or eraser)

Using the Keyboard

Touch characters on the keyboard to enter them. You can touch and slide letters into the editing area in any order you please.

[A1] Alphanumeric

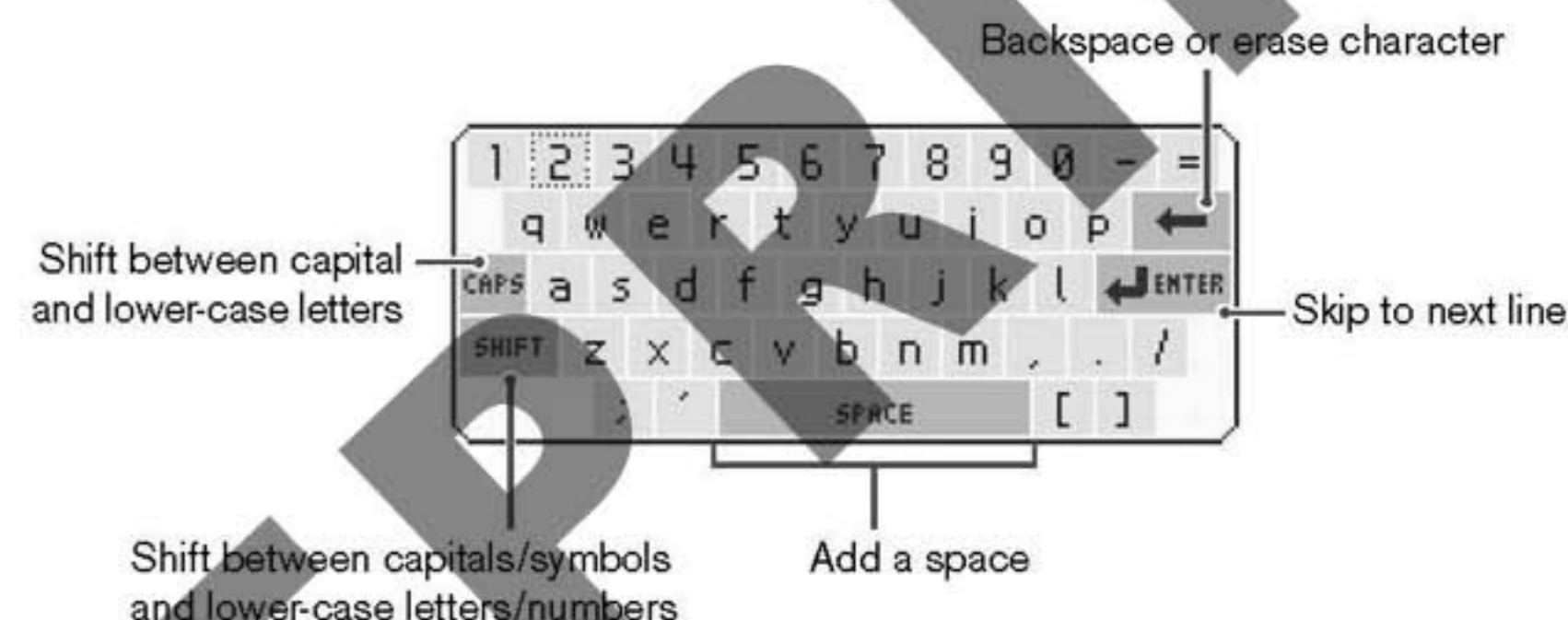

[A] International

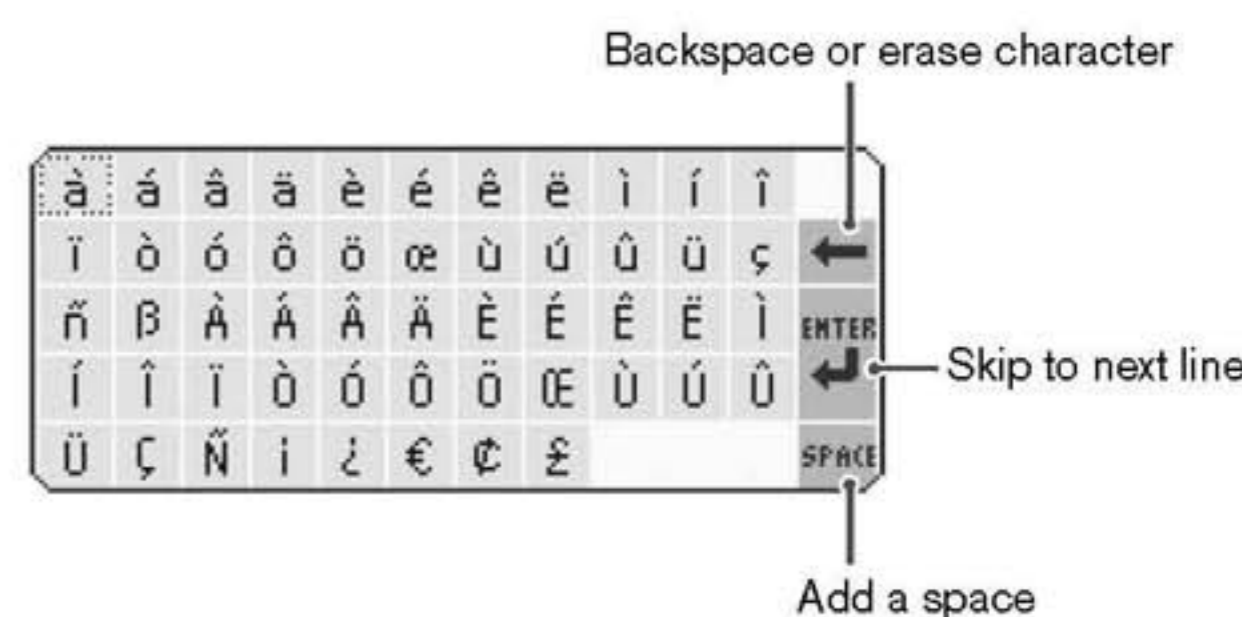

You can also use buttons to control the keyboard.

[+]	Move the cursor
[A]	Enter a character
[B]	Erase the last character entered
[X]	Shift to upper-case letters/Use CAPS
[Y]	Switch keyboard types
[L/R]	Scroll through messages
[START]	Send message
[SELECT]	Press for a short time: Copy last message/ Press for a long time: Erase message





## System Settings

Select SYSTEM SETTINGS from the **Nintendo DSi Menu** to open the **Settings Menu**, from which you can adjust many different options. Use ◀▶ to turn pages, and touch the setting you want to adjust.

### System Settings 1



#### ■ DATA MANAGEMENT:

Manage the System Memory or SD Card data here.  
This item will only appear after you have opened Nintendo DSi Shop.

Page 68 →

#### ■ WIRELESS COMMUNICATIONS:

Turn DS Wireless Communications on or off.

Page 69 →

#### ■ BRIGHTNESS SETTINGS:

Adjust screen brightness.

Page 69 →

### System Settings 2



#### ■ PROFILE:

Edit your user name, message, birthday and favourite colour.

Page 70 →

#### ■ DATE:

Set the current date.

Page 71 →

#### ■ TIME:

Set the current time.

Page 71 →

#### ■ ALARM:

Set a time for the alarm.

Page 71 →

### System Settings 3



#### ■ PARENTAL CONTROLS:

Set up Parental Controls to limit access to certain content.

Page 72 →

#### ■ TOUCH SCREEN:

Calibrate Touch Screen input.

Page 77 →

#### ■ MIC TEST:

Check microphone sensitivity.

Page 77 →

#### ■ INTERNET:

Configure your internet settings.

Page 78 →

### System Settings 4



#### ■ LANGUAGE:

Select a language for your system.

#### ■ COUNTRY:

Select your country of residence.

#### ■ SYSTEM UPDATE:

Update your Nintendo DSi system and built-in applications.

Page 94 →

#### ■ FORMAT SYSTEM MEMORY:

Delete all added software and save data.

Page 94 →

## Data Management

Copy or delete software or save data from your System Memory or from an SD Card. When copying data you must insert an SD Card.

### Copying/Erasing

- 1 Select where the data you want to delete or copy is located.



- 2 Select the data you want to copy or delete.

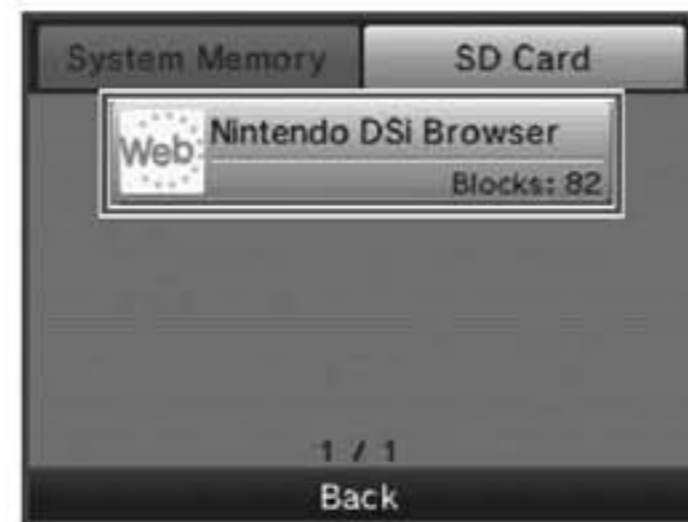

- 3 Select either COPY or DELETE.



### You cannot copy under any of the following circumstances:

- When there is no SD Card in the SD Card Slot.
- When there is not enough space available in the area to which you want to copy.
- When the data you have selected cannot be copied.
- When you want to copy to the **Nintendo DSi Menu** but there are no available boxes.
- When you want to copy to a system that is not where the original data is saved.
- When the SD Card you want to copy to contains 300 blocks or more of software or save data.
- When the SD Card you want to copy to is write protected.

## DS Wireless Communications

Turn wireless communications on and off.

### Setting DS Wireless Communications

- 1 Simply touch ON to turn wireless communications on and OFF to turn them off.
- 2 Touch OK to confirm.

**Note:** Make sure you set wireless communications to OFF when on board an aeroplane.



## Brightness Settings

Adjust the brightness of the screens.

### Adjusting brightness

- 1 Touch + or - to adjust the brightness.
- 2 Touch OK to confirm your adjustments.

While playing a game, you can press and hold SELECT then use the volume control to adjust the brightness.

Use caution when using SELECT to make adjustments as pressing SELECT in certain games may activate game functions or cause the game to skip scenes.

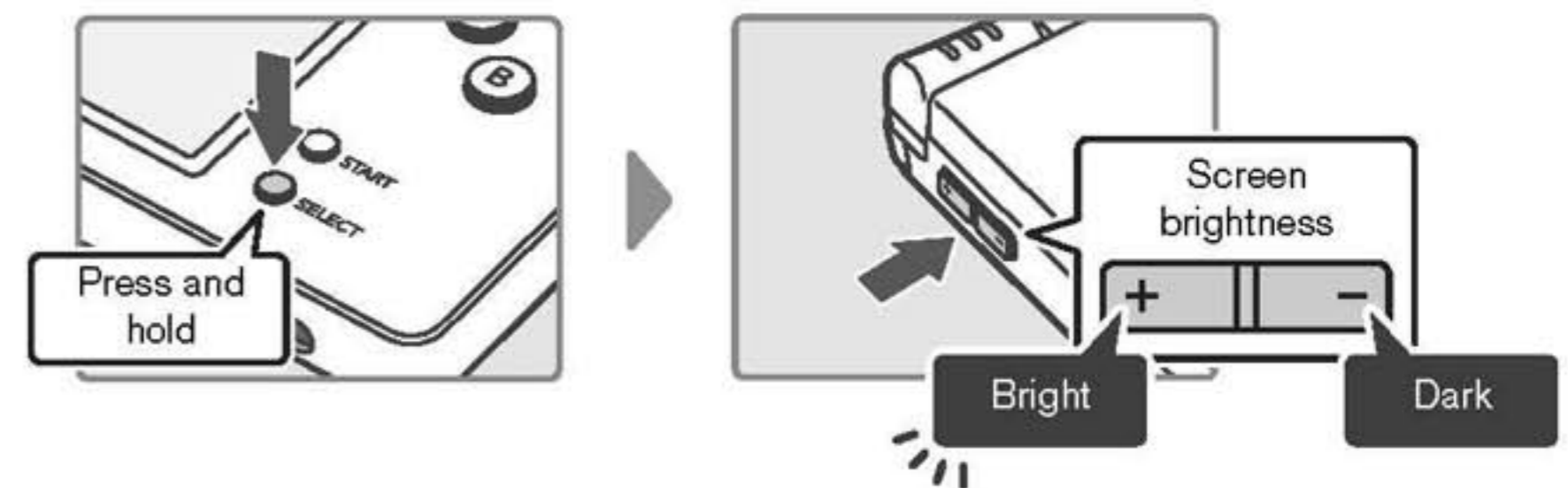

### About Screen Brightness and Battery Life

Increasing screen brightness will decrease battery life, and decreasing screen brightness will increase battery life. Please bear this mind when you adjust your brightness settings. [Page 114](#) →

## Profile

Make adjustments to your user name, message, favourite colour, and birthday.



### User Name

- 1 Use the keyboard to enter your user name. See [Page 95](#) → for keyboard instructions.
- 2 Touch OK to confirm.



### Message

- 1 Enter a personalised message using the keyboard. See [Page 95](#) → for keyboard instructions.
- 2 Touch OK to confirm.  
The personalised message you enter here will be displayed on other users' systems when using PictoChat, so think about entering a greeting or a short introduction.



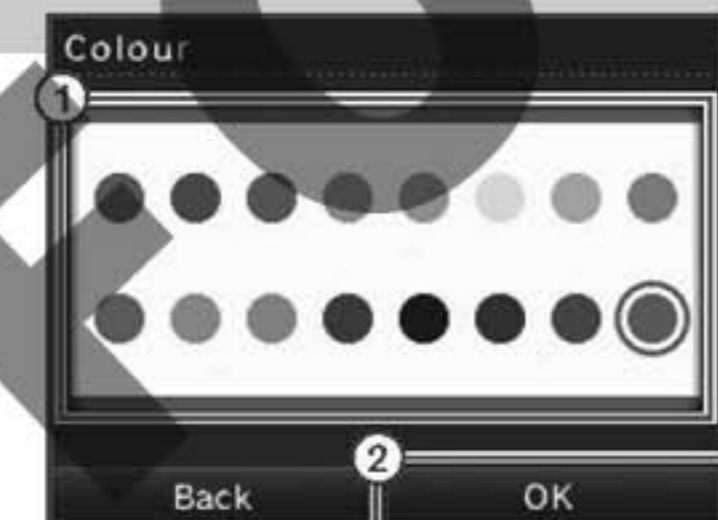

### Colour

- 1 Touch the colour you like.  
This colour will be used in various places, such as the **Nintendo DSi Menu**.
- 2 Touch OK to confirm.



### Birthday

- 1 Use   to set the date of your birthday.
- 2 Touch OK to confirm.





## Date

Set the current date.

Some games use this setting, so be sure to enter the correct date.

### Setting the date

- 1 Use   to adjust the day, month and year.
- 2 Touch OK to confirm.





## Time

Set the current time.

Some games use this setting, so be sure to enter the correct time.

### Setting the time



- 1 Use   to adjust the time.
- 2 Touch OK to confirm.



## Alarm

Set a time for the alarm.

### Setting the alarm

- 1 Use   ① to adjust the time to when you want the alarm, and then touch OK ② to turn the alarm on.
- 2 Touch YES to confirm. Both screens will automatically be set to the lowest brightness setting.



To turn off or cancel the alarm, touch the Touch Screen or any button other than the L and R Buttons.

Once the alarm has gone off, it will enter **Snooze Mode** and the alarm will continue to sound every five minutes until it has been turned off. **Snooze Mode** ends automatically after one hour.

## Parental Controls

Parental Controls settings allow parents or guardians to manage what content can be used or downloaded on the Nintendo DSi system. There is one Parental Controls setting per system, so it is recommended that you choose the most secure setting required for your family; you can then share the PIN with users who may be allowed access to blocked content.

### What Can Parental Controls Restrict?

- Nintendo DSi software/Nintendo DSi compatible software
  - Restrict usage of software based on PEGI/BBFC\* rating guidelines. You cannot use this to restrict the use of Nintendo DS/DS Lite software or software downloaded via DS Download Play.
- PictoChat
  - Restrict the use of this application.
- DS Download Play
  - Restrict the use of this application.
- Nintendo DSi Browser
  - Restrict the use of Nintendo DSi Browser to browse the internet. Nintendo DSi Browser is an internet browser that can be used to view web pages online. If you do not want to allow unlimited access to the internet, you should turn the Parental Controls on or pay for a commercial internet-filtering service.
- Nintendo DSi Shop
  - Restrict the purchase of software using PEGI/BBFC\* rating guidelines.
  - Set limits on Nintendo DSi Points usage. You can only limit Nintendo DSi Points usage, not the purchase of Nintendo DSi Points.
- Photo exchange
  - Restrict the exchange of photo data over DS Wireless Communications.
- Others
  - Restrict the user-generated content that can be received.

\* BBFC (British Board of Film Classification) ratings may be used in certain cases instead of a PEGI rating. For further information about BBFC ratings please visit <http://www.bbfc.co.uk>

## Pan-European Game Information (PEGI) Video and Computer Game Software Rating Information Icons

### Age rating categories



www.pegi.info  
Titles rated 3+ are suitable for ages 3 and older



www.pegi.info  
Titles rated 7+ are suitable for ages 7 and older



www.pegi.info  
Titles rated 12+ are suitable for ages 12 and older



www.pegi.info  
Titles rated 16+ are suitable for ages 16 and older



www.pegi.info  
Titles rated 18+ are suitable for ages 18 and older

### Content descriptors

Content descriptors will be displayed on the software packaging. The content descriptors indicate content that is determined based on age.



Bad Language



Fear



Discrimination



Sexual Content



Drugs



Violence



Gambling



The PEGI Online logo indicates that a game allows the player to have access to online game play. For further information about online gaming please visit:

<http://www.pegionline.eu>

The PEGI system was developed and based on existing systems in Europe. In the drafting of the PEGI assessment form and the shaping of the system organisation, society representatives such as consumers, parents and religious groups have been largely involved. For further information about the Pan European Game Information (PEGI) rating system visit: <http://www.pegi.info>.

**Note:** This age rating system does not indicate ease or difficulty of a game.

## Setting up Parental Controls.

- 1 Follow the on-screen instructions

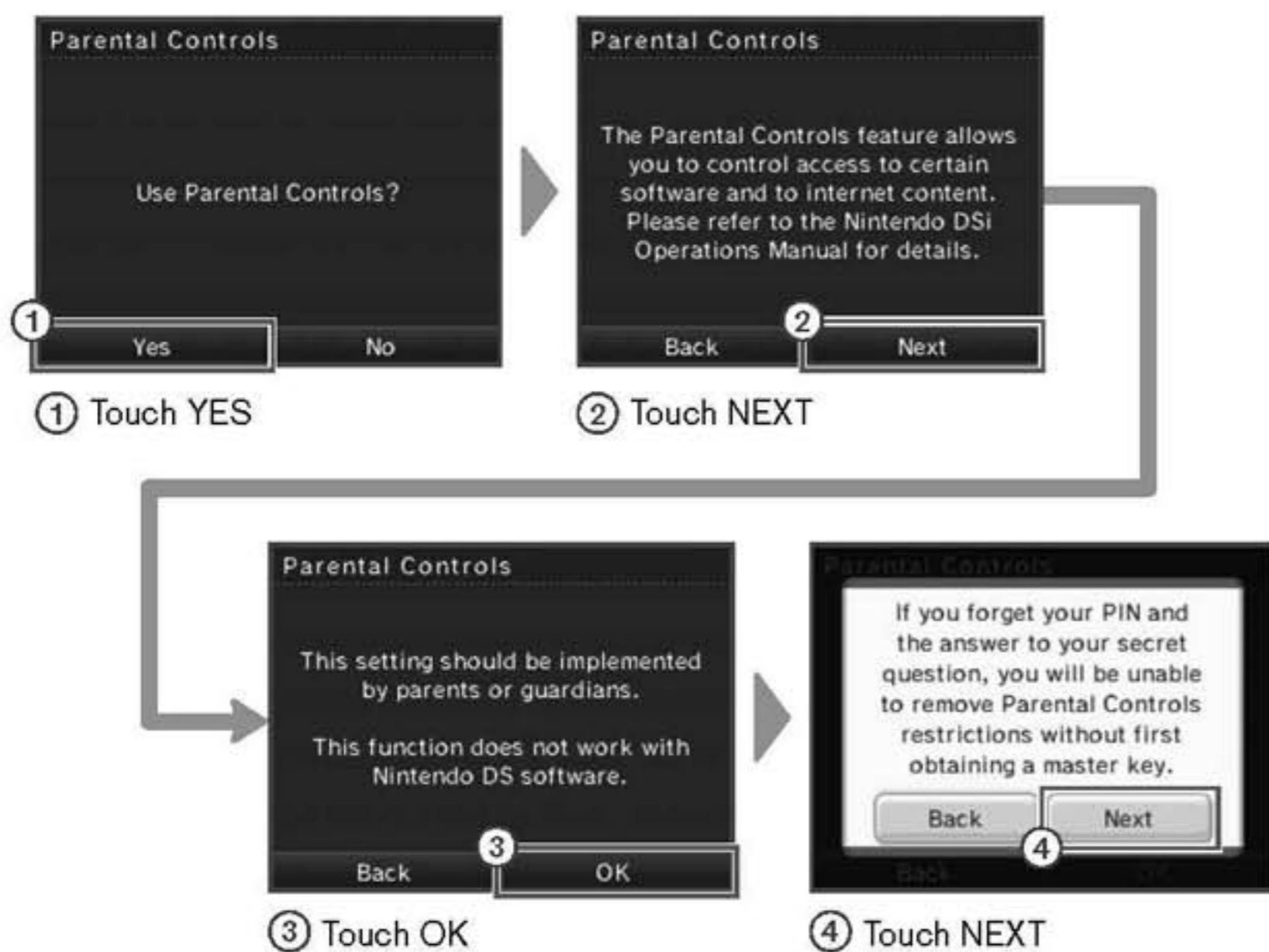

- 2 Enter a four-digit PIN of your choosing, then touch OK. (You will need to enter the number twice to confirm that it is correct.)

You will need this PIN to turn Parental Controls off temporarily or to change your settings. Please remember this number.



- 3 Use ▲▼ to choose a secret question and then touch OK.



- 4 Enter an answer to the secret question and then touch OK. The answer must be six or more characters long.

The answer to your secret question will be used in the event that you forget your PIN, so you should choose an answer you are unlikely to forget.

See [Page 95](#) → for instructions on using the keyboard.



- 5 Now follow the on-screen instructions to set up Parental Controls options.



## Parental Controls

### If you forget your PIN and the answer to your secret question...

If you forget both your PIN and the answer to your secret question, please follow these steps.

- 1 On the PIN Input Screen, select I FORGOT.



- 2 On the next screen, enter the answer to your secret question.

If you successfully answer the secret question, proceed with editing your Parental Controls settings.



If you've forgotten the answer to your secret question...

- 3 Select I FORGOT.

- 4 An Enquiry Number will be displayed.

Ring the number given in the Nintendo DSi Operations Manual and provide the Enquiry Number shown here. You will then be issued a master key.

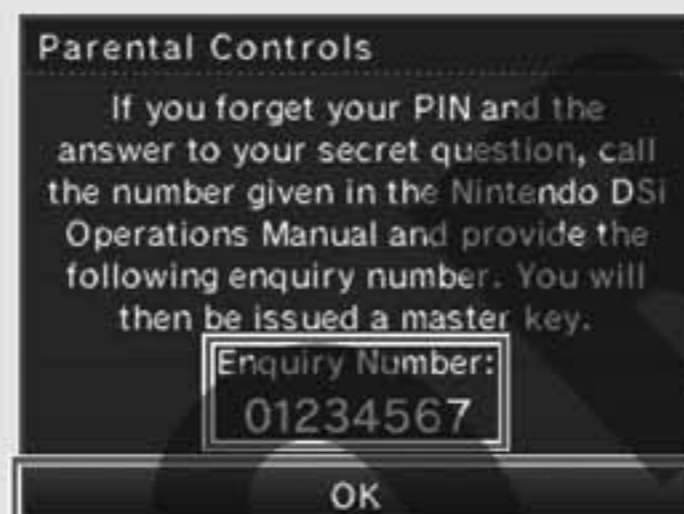
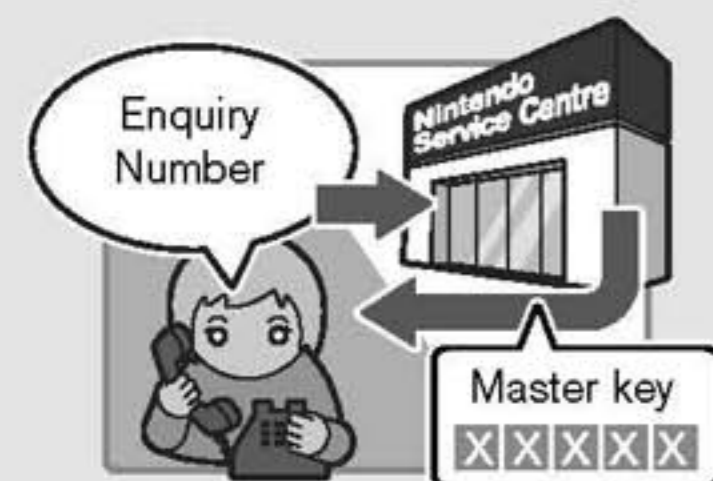

- 5 Touch OK.

- 6 Enter the master key and select OK.



## Touch Screen Calibration

If the Touch Screen is not responding properly or if you feel the stylus contact point is not aligned correctly, take the following steps to recalibrate the Touch Screen.

In the event you are unable to use the stylus at all, press and hold L Button + R Button + START, then turn the power on. The **Calibration Screen** will be the first screen to display.

### Calibrating the Touch Screen

- 1 Carefully touch the centre of . Calibration points will appear in the upper-left corner, lower-right corner, and the centre of the screen. Touch each point to complete calibration.



- 2 When CALIBRATION COMPLETE appears on the screen, touch each of the four  to confirm.

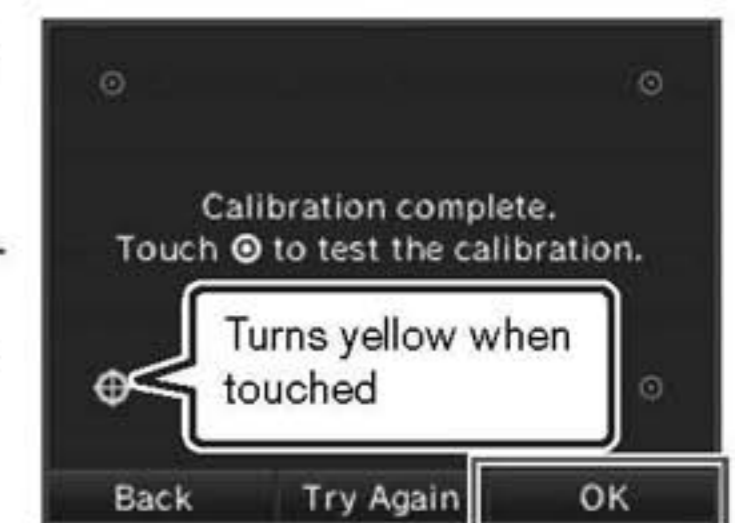

- 3 When you've finished confirming calibration, touch OK to finish. If you were unable to accurately touch , select TRY AGAIN to restart the calibration process.

## Mic Test

Confirm that the microphone is operating properly.

### Testing the Microphone

- 1 Face the microphone and speak.

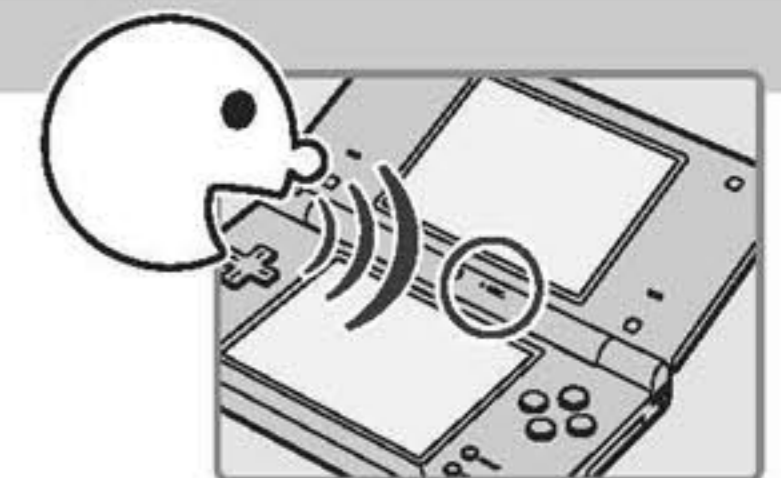

- 2 Confirm that the volume bar fills up with coloured bars. If the volume bar fills with coloured bars when you speak, the microphone is working properly.

The volume bar will fill with coloured bars when it picks up sound.



- 3 Touch QUIT when you've finished confirming that the microphone is working.

Connecting your Nintendo DSi to a wireless broadband internet connection.

Internet

- Connection Settings Set up an internet connection.
- Options Confirm MAC address. [Page 96 →](#)  
Transfer or delete the Nintendo WFC Configuration saved on the Nintendo DSi. [Page 92 →](#)
- User Agreement Review and agree to Nintendo DSi Network Services Agreement.
- Back

**AOSS™** and AOSS™ are the trademarks of BUFFALO INC.  
Windows® and Windows Vista® are trademarks of the Microsoft group of companies.

You can also perform settings for WPA level high security, proxy settings, and settings for advanced users capable of connecting via WPS. [Page 90 →](#)

**Note:** For more information on the Nintendo Wi-Fi USB Connector, visit [support.nintendo.com](http://support.nintendo.com). Connection settings in Advanced Setup (connections 4, 5 and 6) cannot be used with Nintendo DS software. When connecting to the internet with Nintendo DS software, use the usual internet settings (connections 1, 2 and 3).

Setup manually. [Page 88 →](#)

Select setup method

Your connection-setup process depends on your home network environment. First answer the following questions, then use the appropriate setup method.

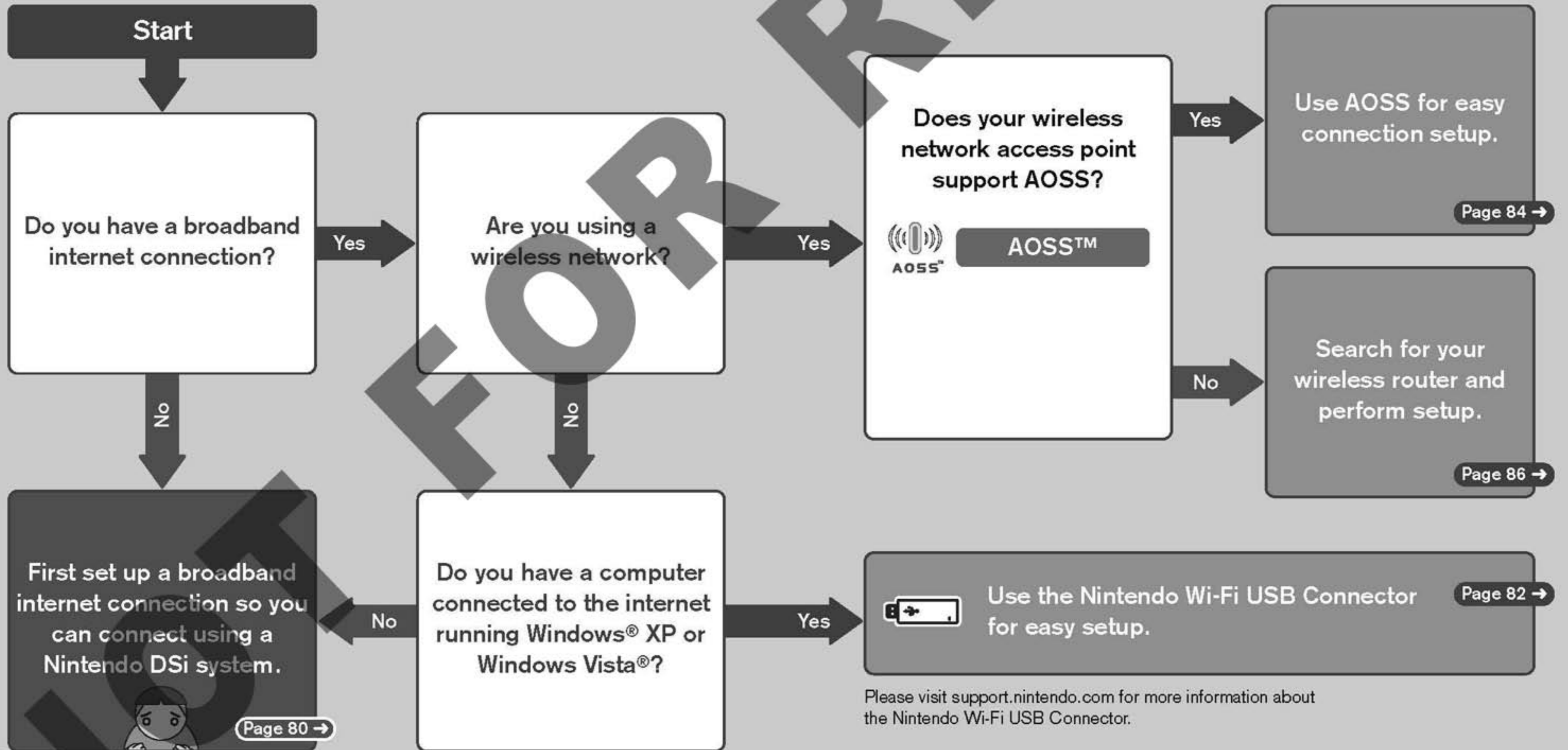

Other settings here

Please visit [support.nintendo.com](http://support.nintendo.com) for more information about the Nintendo Wi-Fi USB Connector.

## Required for connecting to the internet

The following are required to connect a Nintendo DSi to the internet.

## 1. Nintendo DSi system



## 2. PC



## 3. Broadband internet environment using DSL, Cable, etc.



## 4. Use any of the following devices for connecting your Nintendo DSi wirelessly

1



Nintendo Wi-Fi USB Connector [Page 82 →](#)

Even if you don't have a wireless connection in your home, you can connect your Nintendo DSi system to the internet by connecting the Nintendo Wi-Fi USB Connector to a USB port of a PC running Windows® XP/Windows Vista® that has a broadband internet connection and is running the software included with the connector.

2



Commercially-Available Access Point  
(Wireless Router, etc.)

[Page 84 →](#)  
and  
[Page 86 →](#)

**Note:** In this manual, "wireless router access points" are referred to simply as "access points." Please use an access point supporting 802.11b or 802.11g standard. You cannot use access points supporting 802.11a exclusively.

For a list of access points (routers) that can be recognised by a Nintendo DSi system, visit [support.nintendo.com](http://support.nintendo.com).

## Even if you don't have a wireless internet environment at home...

You can take your Nintendo DSi to a nearby Nintendo DS Centre and connect to the internet without any setup.

Nintendo DS Centres can be found in electronics retailers.  
For more information, visit

 NINTENDO DS™  
CENTRE

<http://nintendodscentre.nintendo.co.uk>



Connecting using the Nintendo Wi-Fi USB Connector (sold separately)

By connecting the Nintendo Wi-Fi USB Connector to a USB port of a PC with a broadband internet connection, you can use the PC as an access point.

**Note:** Before performing the following settings, install the Nintendo Wi-Fi USB Connector Registration Tool on the computer and ready it for use. Refer to the Nintendo Wi-Fi USB Connector Operations Manual for details.

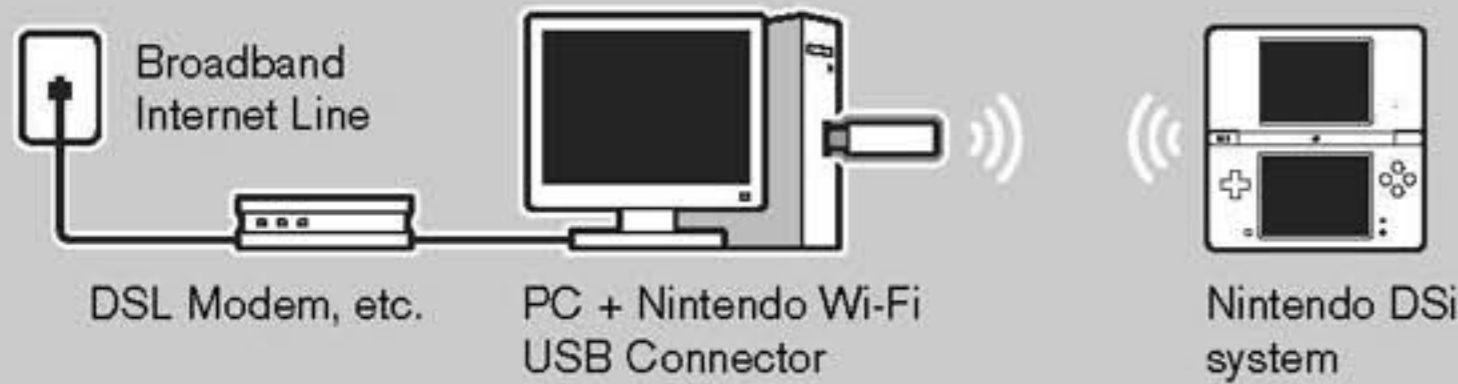

How to Connect

1 Touch CONNECTION SETTINGS.

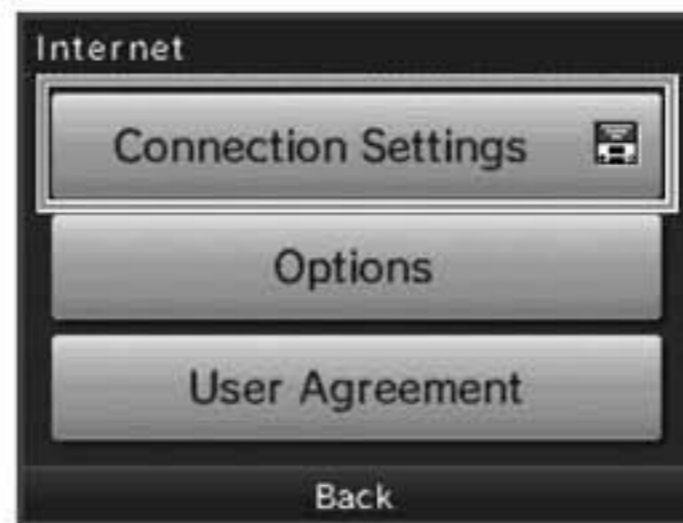

2 Touch NINTENDO Wi-Fi USB CONNECTOR.

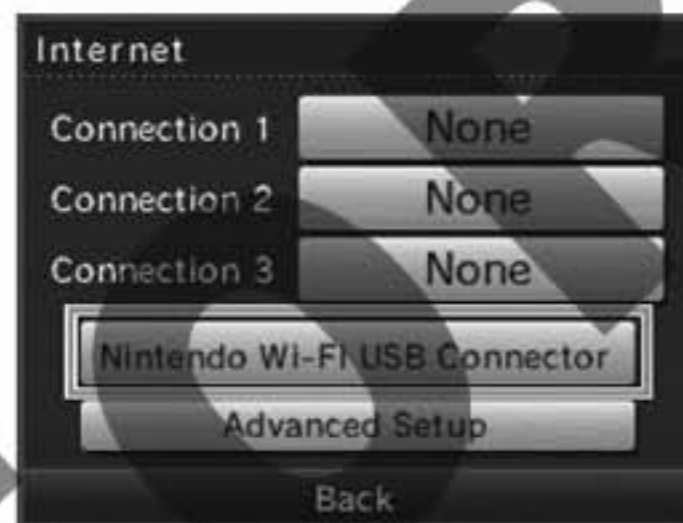

3 Confirm that the Nintendo Wi-Fi USB Connector is ready for use and touch NEXT.



4 Proceed to the following PC steps once this screen is displayed.



PC Steps

5 Click on the icon in the notification area of the taskbar.  
↓  
The Registration Tool is displayed.



6 Select the user name you want to connect from the displayed user names on the Nintendo DSi system ①.  
↓  
Select PERMIT CONNECTION from the displayed menu ②.



Select the user name you want to connect

**Note:** The screens shown are from Windows XP.

7 Touch OK to perform a connection test.



If the connection test is successful, setup is complete

**Note:** If connection fails, refer to the list of error codes in the Support and Troubleshooting section [Page 110](#) → .

## Connecting using AOSS

If your access point supports AOSS, you can use this functionality for an easy connection setup. Also refer to the instruction manual of your access point.

**Note:** Using AOSS may cause your access point settings to change. If you're connected to a computer without using AOSS, it may no longer connect after using AOSS.

## How to Connect

- 1 Touch CONNECTION SETTINGS.

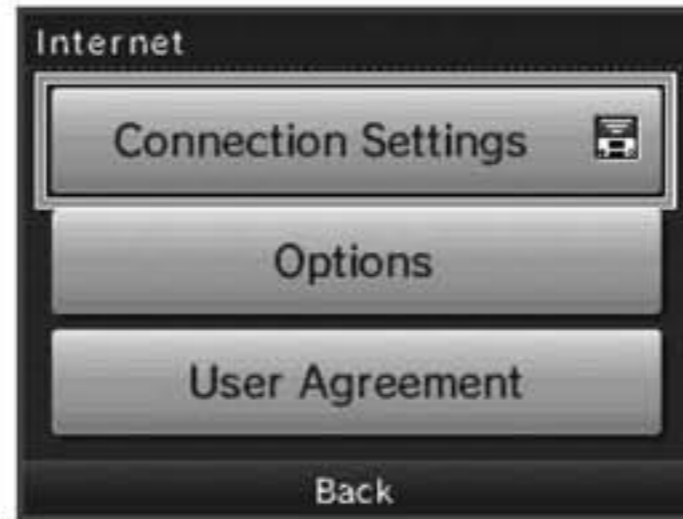

- 2 Touch an open connection, indicated by NONE.



- 3 Touch the AOSS icon.

Proceed to the following access point steps.



## 4 Access point steps

## Using AOSS

Press the AOSS Button until the lamp starts blinking.

**Note:** If connection continues to fail when performing AOSS settings, wait approximately 3 minutes and then try again.

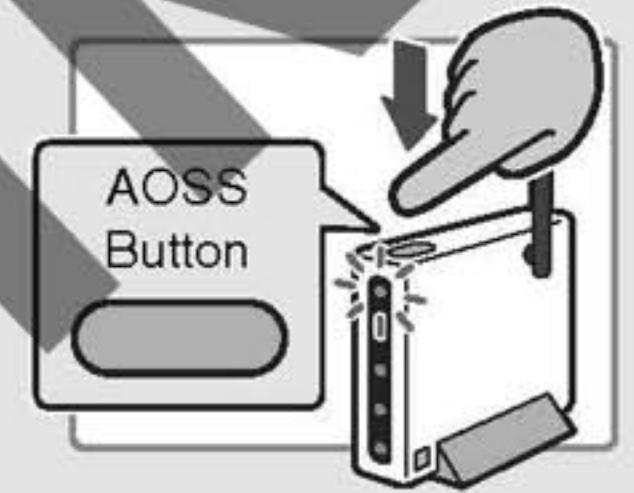

- 5 Touch OK to perform a connection test.

## Using AOSS



If the connection test is successful, your settings are complete.

Immediately after completing settings for AOSS, connection may fail due to the restarting of the access point. Wait a short while, then try performing a connection test again.

Searching for and connecting to an access point

You can use this method to search for and connect to an access point if your access point does not support AOSS.

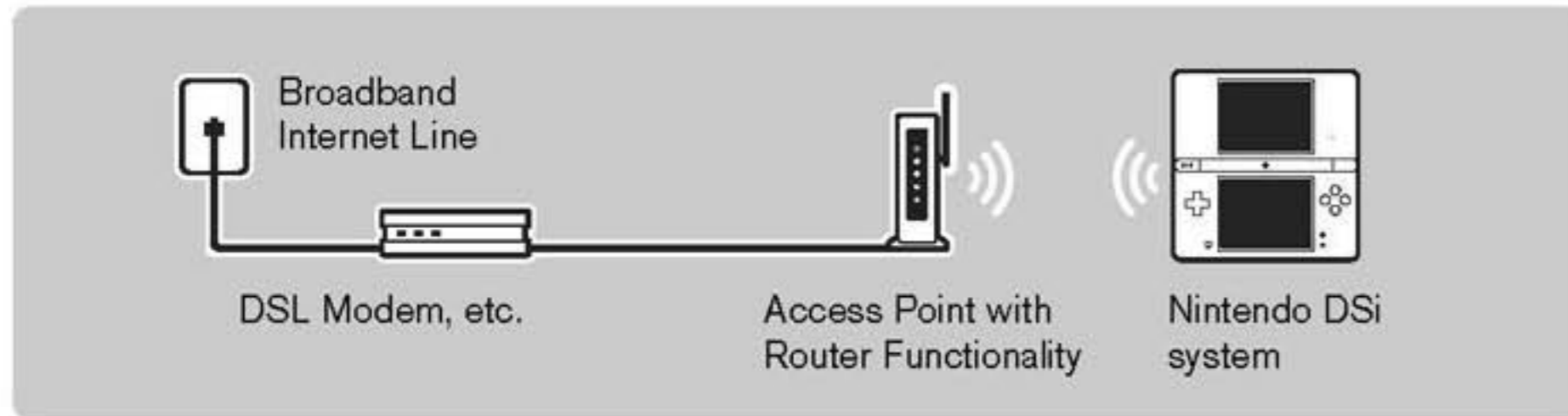

How to Connect

1 Touch CONNECTION SETTINGS.

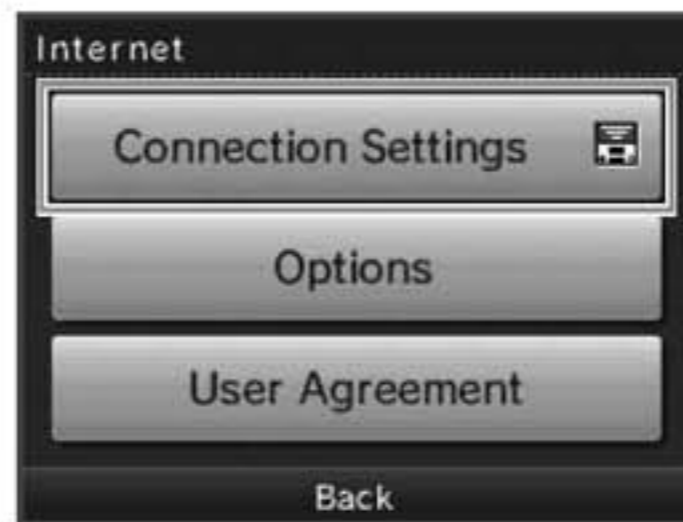

2 Touch an open connection, indicated by NONE.



3 Touch SEARCH FOR AN ACCESS POINT.



4 Touch an access point to select it.  
If no access points are found, try configuring settings manually.  
[Page 88 →](#)



5 Enter the key and touch OK  
This is displayed only when configured for security.



6 Touch OK.



7 Touch OK to perform a connection test.



If the connection test is successful, setup is complete

Note: If connection fails, refer to the list of error codes in the Support and Troubleshooting section [Page 110 →](#).

Access points marked require that you enter the same key as registered with the access point. [Page 97 →](#)

Key input not required	Configured with an unsupported encryption format. To connect to access points with this mark, configure settings through Advanced Setup. <a href="#">Page 90 →</a>
Key input required	

The icon (Reception Strength icon) indicates the state of signal reception and displays at four different levels. Stronger signal reception results in smoother transmission.

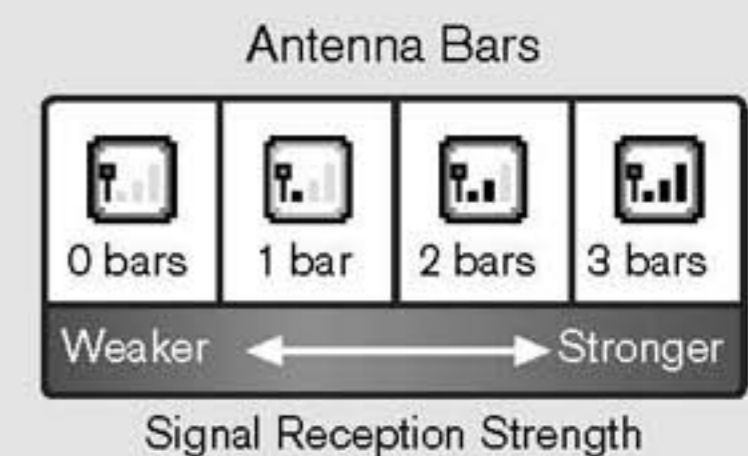

Configuring settings manually

Configure your access point's settings manually.

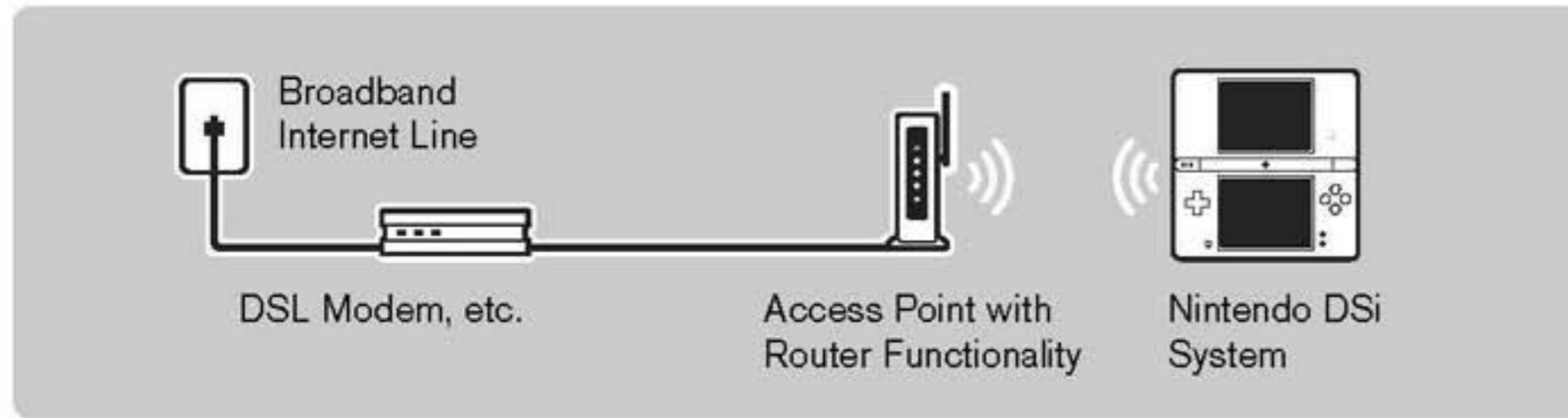

How to Connect

1 Touch CONNECTION SETTINGS.

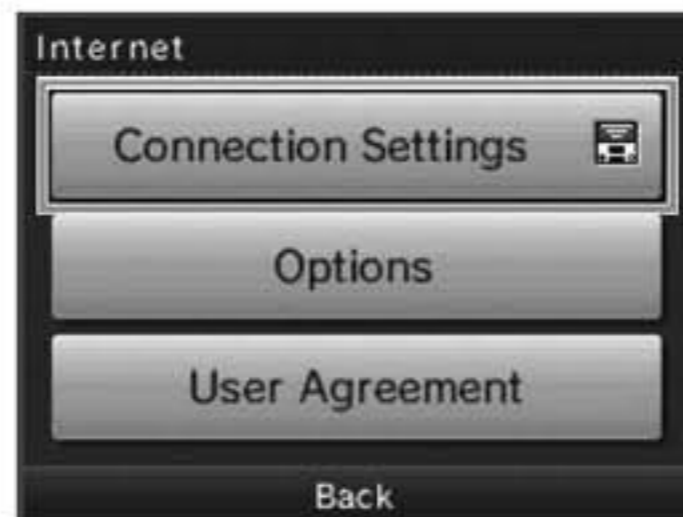

2 Touch an open connection, indicated by NONE.



3 Touch MANUAL SETUP.



4 Set each field and touch SAVE when finished. When setting the IP address manually, be sure to also set the DNS.

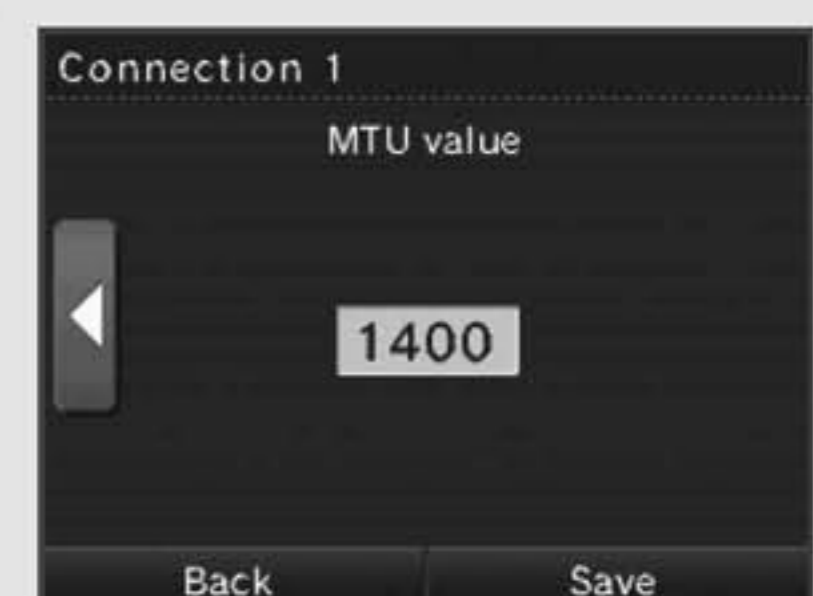

Proxy settings can only be configured when configuring Advanced Setup.

5 Touch YES to perform a connection test.



If the connection test is successful, setup is complete

Note: If connection fails, refer to the list of error codes in the Support and Troubleshooting section Page 110 → .

Advanced Setup

In Advanced Setup you can configure settings for connecting to the internet using software that supports Nintendo DSi features, using WPA level high security, proxy settings and settings for connecting with WPS. [Page 94 →](#)

Advanced Setup (connections 4 – 6) cannot be used with Nintendo DS software that does not support Nintendo DSi features. When connecting to the internet with Nintendo DS/DS Lite software, configure normal internet settings (connections 1 – 3).

How to Connect

1 Touch CONNECTION SETTINGS.

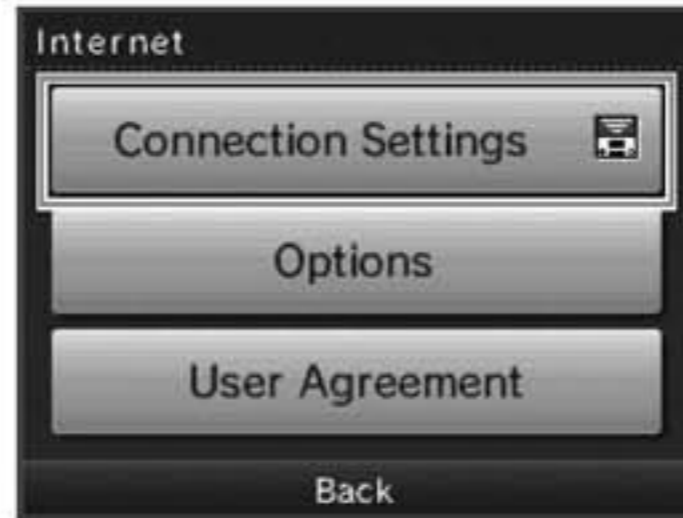

2 Touch ADVANCED SETUP.



3 Touch an open connection, indicated by NONE.



4 Touch the connection method best suited for your connection environment.

To set up using WPS  
Touch the WPS icon and proceed from step 5.



- Using AOSS [Page 84 →](#)
- Searching for an access point [Page 86 →](#)
- Manual setup [Page 88 →](#)

**Note:** The following instructions are the same as for configuring normal settings.

5 Touch the connection type best suited for your access point.



6 Access point steps

**Push-Button Connection**  
Continue to push the WPS Button until the lamp blinks.

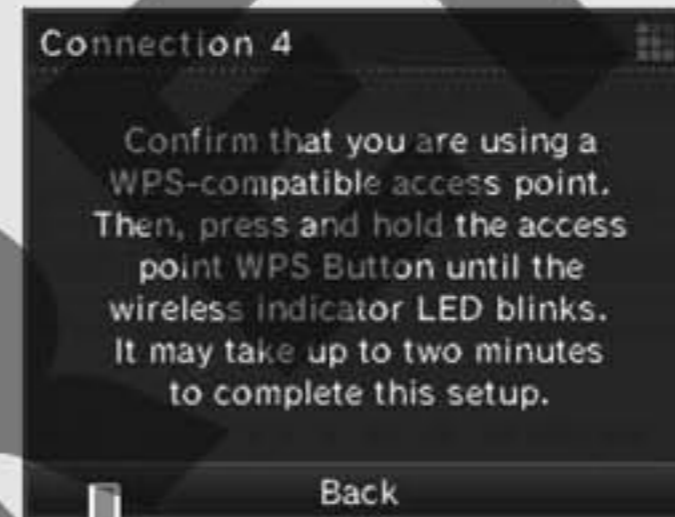

**Pin connection**  
Set the PIN number displayed on the Nintendo DSi system's Touch Screen in your access point.



It may take as long as 2 minutes until setup completes.

7 Touch NEXT.



8 Touch OK to perform a connection test.



**If the connection test is successful, setup is complete**

Immediately after completing settings using WPS, connection may fail due to the restarting of the access point. Wait a short time, then try performing a connection test again.

Options

Confirm system information, delete Nintendo WFC Configurations and transfer Nintendo WFC Configurations.



Warnings

- Please delete the Nintendo WFC Configuration before disposing of or releasing your system.
- When changing to a new system, transfer the Nintendo WFC Configuration from the old system to the new system.
- When deleting or transferring the Nintendo WFC Configuration, settings such as Friend Rosters and connections will be deleted from the source system.

Transferring Nintendo WFC Configuration to another system

Nintendo WFC Configuration transfers use DS Download Play.

**Note:** This deletes Nintendo WFC Configuration from the source system and overwrites the Nintendo WFC Configuration of the target system. When transferring to a Nintendo DS / DS Lite system, content of the Internet Advanced Setup information is not transferred.

Things to prepare

- Source Nintendo DSi system
- Target system (Nintendo DSi system or Nintendo DS/DS Lite system)

How to transfer

1 On source system

Touch TRANSFER NINTENDO WFC CONFIGURATION.  
Follow the on-screen instructions.



2 On target system

Touch DS DOWNLOAD PLAY.  
Follow the on-screen instructions.



3 On source system

Confirm that the user name displayed is indeed that of the target system and touch YES.



4 On target system

Touch OK if you agree to the on-screen warning.  
**Note:** If you touch NO, the transfer of the Nintendo WFC Configuration will be aborted.



5 On source / target system

When the transfer is complete, a confirmation message is displayed. Touch OK and OK on the respective systems.



## System Update

There will be updates or additions to the **Nintendo DSi Menu** or applications. Updates will take place by connecting to the internet, so please complete your internet connection settings ahead of time.

Page 78 →

### How to Update

- 1 Touch YES.

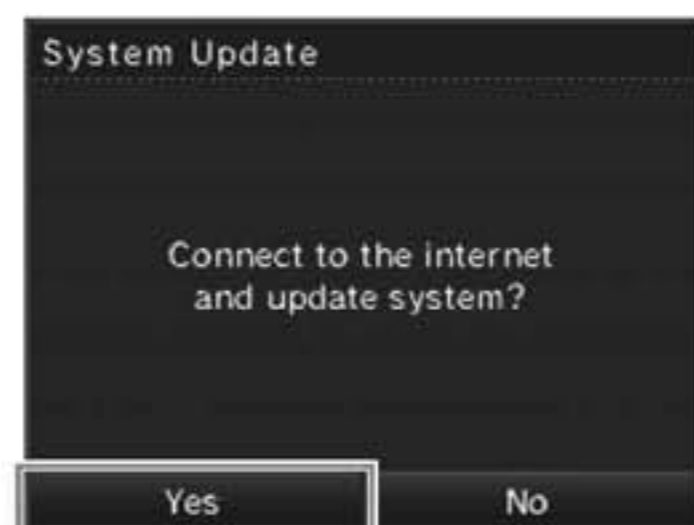

- 2 Read the on-screen text carefully and select NEXT.

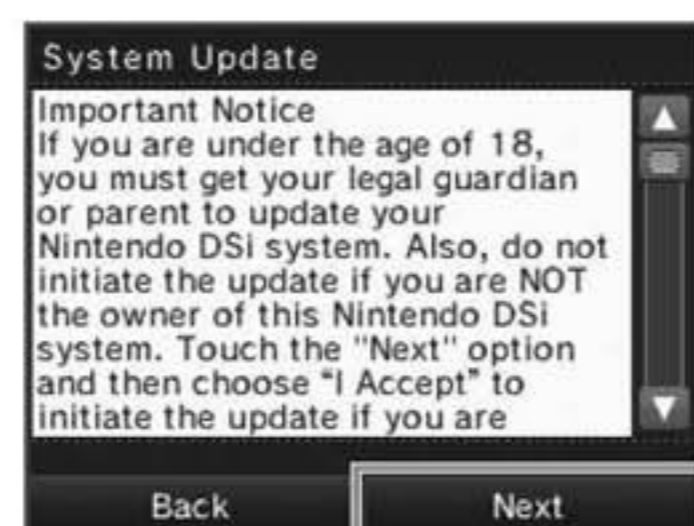

- 3 If you agree with what you read in 2 select I ACCEPT, and then touch OK.



## Format System Memory

Choose this to erase all save data, and return the system to the state in which it was purchased.

- 1 Select FORMAT.

### What data will be erased?

- Software purchased via Nintendo DSi Shop or added by Nintendo DSi software.

**Note:** Software purchased via Nintendo DSi Shop can be downloaded again free of charge.

- Data saved on the System Memory.
- Changes made to the System Settings.

**Note:** Data erased by formatting the system cannot be restored.

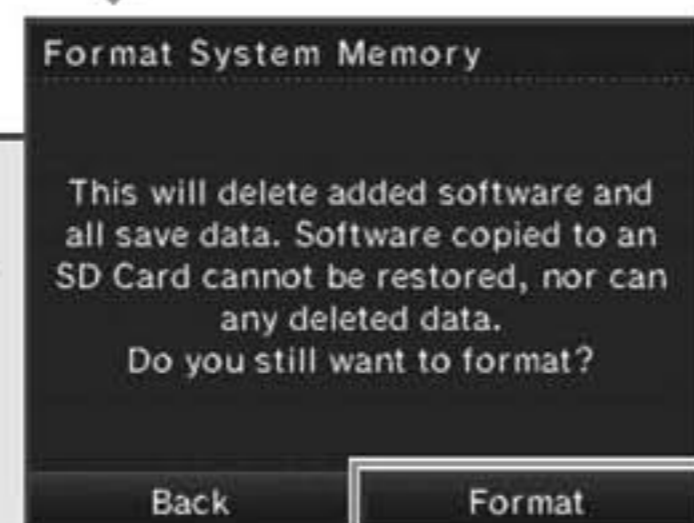

## Using the Keyboards

Keyboards will be displayed on the Touch Screen when you are required to enter characters. There are two types of keyboard, a standard alphanumeric keyboard and a ten-key keyboard.

### Alphanumeric Keyboard

#### Character type selection keys

- Displays the input keyboard for letters of the alphabet and numbers.
- Displays the input keyboard for special characters.
- Japanese hiragana, katakana
- Displays the input keyboard for symbols.
- Displays the input keyboard for pictures



The special character, symbol and pictograph keyboards all function in the same way.

### Ten-Key Keyboard

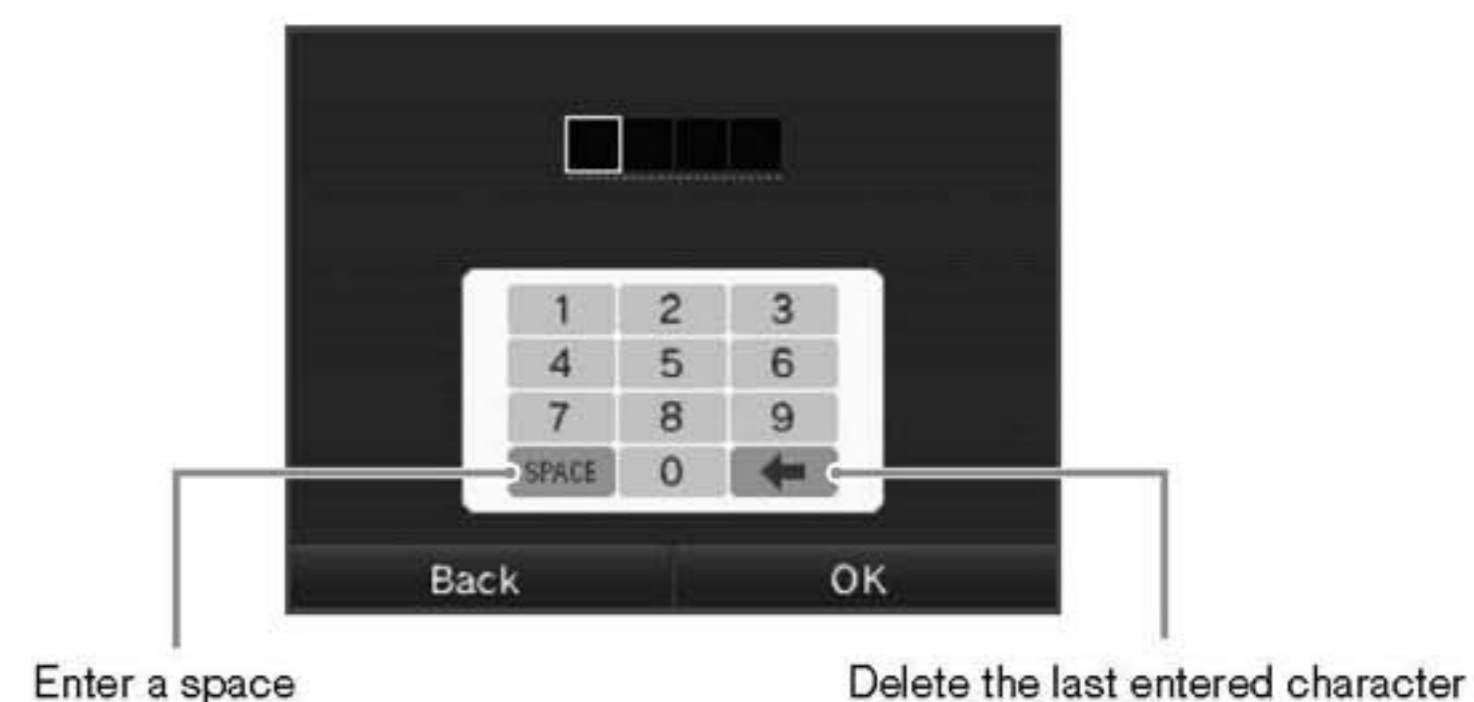

## Glossary

Term	Definition
SSID	The name assigned to an access point. Also known as the ESS-ID or network name.
Key	The key is a numerical value used to encrypt the communications between the Nintendo DSi system and the access point. The same value must be set on the access point and the Nintendo DSi system. It is also known as an encryption key or a network password.
IP address	The number used to specify the destination and transmission source of communications data on the network.
Subnet mask	The numerical value indicating which part of the IP address is the number identifying the network it belongs to.
Gateway	The exit or entrance to the network in question. Its IP address is specified in the connection point settings.
Primary DNS/ Secondary DNS	The server that matches the names of computers on the network to their IP addresses. The IP address of this server is specified in the connection point settings.
DHCP server	The server that specifies the IP address and other information required for communications on the network.
MAC address	The unique number assigned to each device on the network. Your Nintendo DSi system also has a MAC address.
NAT	A function which a network device, such as a router, uses to convert the IP address settings so that a Nintendo DSi system in a LAN can connect to the internet. A connection error may occur when trying to connect to the internet using the NAT feature, depending on the network environment that you are using.
MTU	The maximum value of data that can be sent in one transmission on this network.
WEP	A method for encrypting the data sent between the Nintendo DSi system and the access point.
WPA-PSK(TKIP)/ WPA2-PSK(TKIP)	A method for encrypting the data sent between the Nintendo DSi system and the access point. This encryption method is stronger than WEP.
WPA-PSK(AES)/ WPA2-PSK(AES)	A method for encrypting the data sent between the Nintendo DSi system and the access point. This encryption method is stronger than WEP and TKIP.

Term	Definition
WPS	Short for Wi-Fi Protected Setup. This is a standard for easily executing wireless LAN device connection and security settings.
Proxy	A server that allows users to make an indirect connection to the internet by receiving the information requested by the user first before relaying it to the user's machine.
Nintendo Wi-Fi Connection ID	The unique number allocated to each user that connects to and plays on Nintendo Wi-Fi Connection. This is set automatically the first time the user connects to Nintendo Wi-Fi Connection.
Nintendo Wi-Fi Connection Configuration	Information containing details about connection settings and Nintendo Wi-Fi Connection ID.

Term	Definition
Entering a key for wireless security	<ul style="list-style-type: none"> <li>On the connection settings details screen the key will be displayed as a string of asterisks (*).</li> <li>The key can be input using either ASCII characters or hexadecimal code consisting of the numbers 0 to 9 and the letters "a" to "f".</li> <li>Encryption systems which use a key are the only ones supported by the Nintendo DSi system. If the access point uses some other encryption system, the encryption system used on the access point will need to be changed.</li> <li>For information on configuring the access point settings, refer to the instruction manual provided with your access point.</li> </ul>

Term	Definition
Entering a WEP key	<ul style="list-style-type: none"> <li>Normally, up to four WEP keys can be registered for an access point. In the Nintendo DSi system's connection point settings, the WEP key should be input in the first of the four slots, and the access point settings should also be configured for the use of the same WEP key.</li> <li>The number of characters to be used for the WEP is as follows: ASCII: either 5, or 13, or 16 characters Hexadecimal: either 10, or 26, or 32 characters</li> </ul>

Term	Definition
Entering a WPA key	<ul style="list-style-type: none"> <li>The number of characters to be used for the WEP is as follows: ASCII: between 8 and 63 characters Hexadecimal: 64 characters</li> </ul>



## Error Messages and Error Codes

Please refer to the Support and Troubleshooting section of the Nintendo DSi Operations Manual for information about error messages and codes that are displayed. **Page 109 →**

NINTENDO DS<sup>i</sup>



## Support and Troubleshooting

If you experience problems with your Nintendo DSi system, or an error message or error code is displayed on the screen, use this section of the manual to determine the cause of the problem.

### Contents

• Troubleshooting .....	100
No video or audio output	100
Nintendo DSi Menu	101
I can't use the microphone	101
Charging the Battery Pak	102
I can't use the Touch Screen	103
SD Memory Cards	103
Nintendo DSi Camera	103
Nintendo DSi Sound	104
Nintendo DSi Shop	105
I can't use DS Download Play	105
I can't use PictoChat	105
I'm having difficulty using DS Wireless Communications	106
The system enters Sleep Mode	106
Parental Controls	107
• Error Message List .....	109
• Error Code List .....	110
• Disposal of this product at the end of its life .....	113
• Specifications .....	114

Before seeking assistance, check the following information.

**Note:** In addition to this section of the manual, please read the Instruction Booklet for each piece of software and peripheral device you use.

## No video or audio output

- **Is the power indicator LED lit?**

Press the POWER Button to turn the power on.

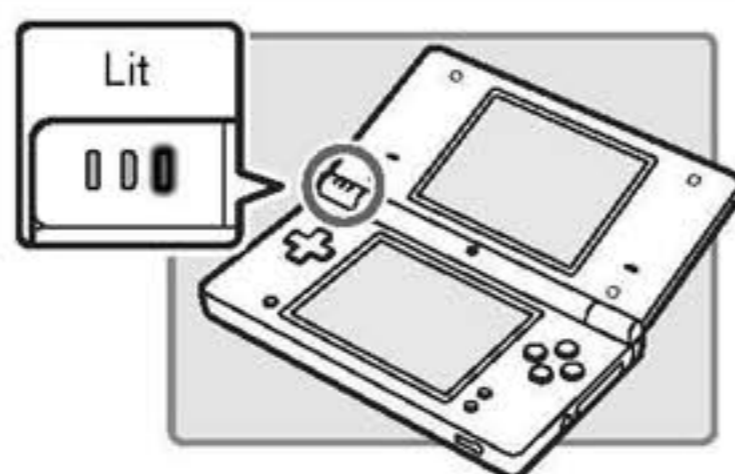

- **Has the Battery Pak been charged?**

Recharge the Battery Pak.

- **Has the Game Card been correctly inserted?**

Insert the Game Card gently but firmly until it clicks into place.

- **Is the system in Sleep Mode?**

The power indicator LED will pulse slowly when the system is in **Sleep Mode**. Check the power indicator LED. Exit **Sleep Mode** by opening the Nintendo DSi system.

## No sound from the system speakers

- **Is the volume set to the lowest level?**

Try adjusting the volume by using the volume / brightness control on the side of the system.

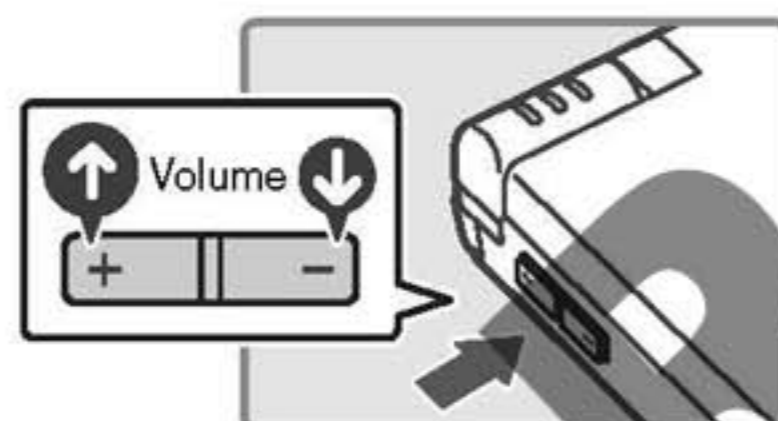

- **Are headphones or a headset connected?**

If headphones or a headset are attached to the Nintendo DSi, no sound will come through the speakers.

## No audio from headphones or headset

- **Is the volume set to the lowest level?**

Try adjusting the volume by using the volume / brightness control on the side of the system.

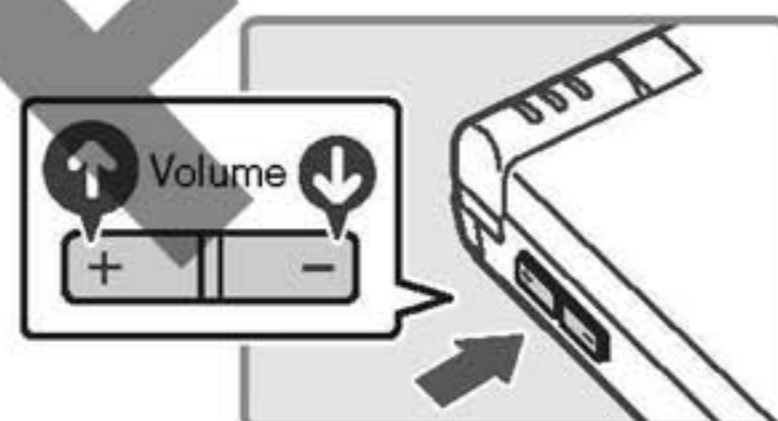

- **Is the plug for the headphones or headset firmly inserted?**

Make sure the headphones or headset are securely plugged into the audio jack.

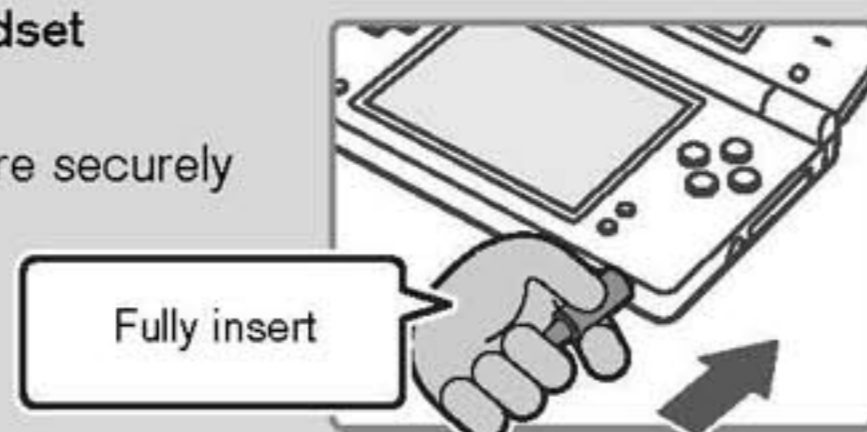

## It takes a long time before the Nintendo DSi Menu is displayed

- **Has a high-capacity SD Memory Card (SD Card) been inserted in the system?**  
It may take time to display the Nintendo DSi Menu if a high-capacity SD Card has been inserted into the system.

## Even though a Game Card has been inserted, the Nintendo DSi Menu displays THERE IS NO CARD INSERTED IN THE DS GAME CARD SLOT

- **Is the Game Card inserted properly?**  
Remove the Game Card and properly reinsert it until it clicks into place. If this doesn't work, try reinserting it a few more times.
- **Are the system's Game Card slot or the Game Card edge connectors dirty?**  
Try using a soft cloth or a cotton swab to clean the connectors.

## I can't play my game

- **Are Parental Controls set to restrict the use of software based on PEGI age ratings?**  
Enter the PIN, and either disable Parental Controls temporarily or disable the Parental Controls item that restricts the use of software based on PEGI age ratings. [Page 107 →](#)

## I can't use the microphone / My voice is not recognised

- **Does this software use the microphone? Does this section of the software make use of the microphone?**  
The microphone cannot always be used. The microphone can only be used in parts of the software that support it.

- **Is the microphone functioning properly?**

Use MIC TEST in System Settings to confirm that the microphone is functioning properly.

[Page 77 →](#)

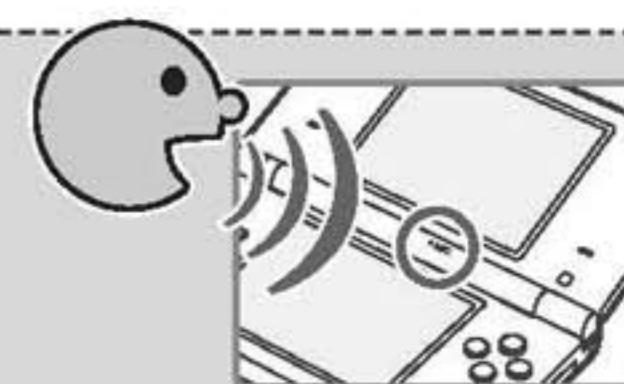

- **Are voices other than your own, such as those of family and friends, recognised correctly?**

There are individual differences in speech recognition rates. Some voices are more difficult to recognise than others.

## The microphone reacts unexpectedly

The microphone may be reacting to audio output from the speaker, or ambient noise. Try to move away from the source of the noise, reduce the speaker volume, use headphones, or try to prevent any background noises. Please use the MIC TEST in System Settings to determine whether the microphone is reacting.

## I can't recharge the Nintendo DSi Rechargeable Battery Pak / The recharge indicator LED is not lit

- **Are you using a Nintendo DSi Power Supply?**

Use the Nintendo DSi Power Supply (WAP-002(EUR)).

- **Is the Nintendo DSi Power Supply firmly inserted into the system and an electrical socket?**

Make sure the Nintendo DSi Power Supply is securely connected to both the Nintendo DSi system and the wall socket.

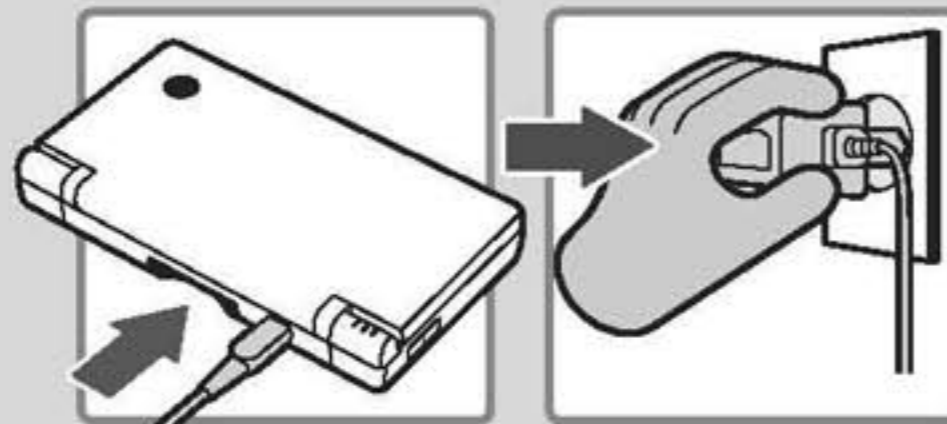

- **Is the Battery Pak being charged in a location with an ambient temperature between 5 and 35 degrees Celsius?**

Charge the Battery Pak in a location with an ambient temperature between 5 and 35 degrees Celsius. You may not be able to recharge the Battery Pak in a location outside of this temperature range.

- **Is the recharge indicator LED lit?**

If the recharge indicator LED is blinking, there is a chance that the Battery Pak is not connected properly. Make sure that the Battery Pak is connected properly.

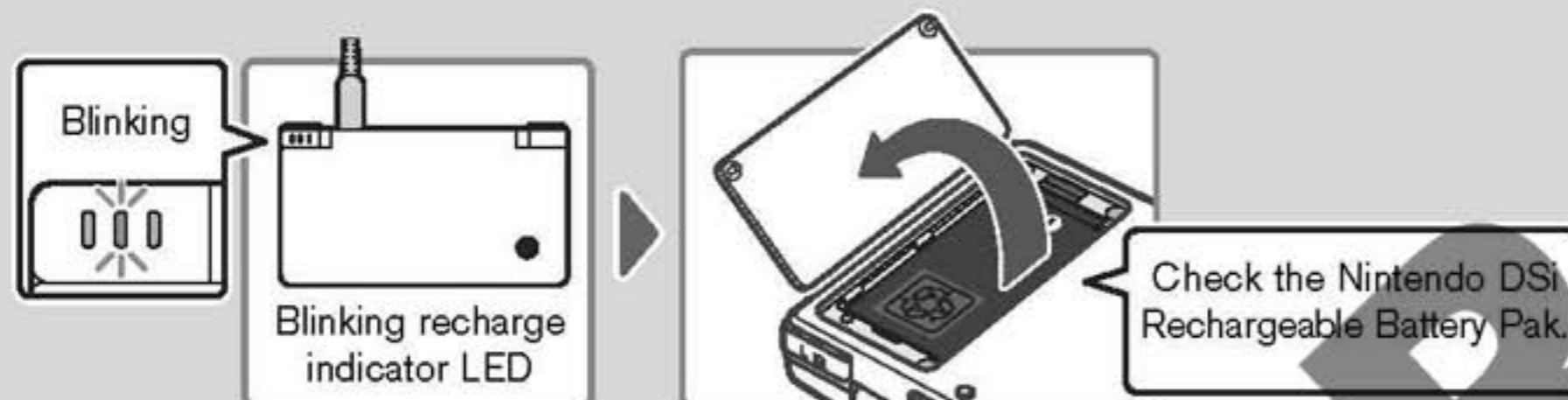

## I charged the Nintendo DSi Rechargeable Battery Pak, but I can't play for long periods of time / It takes a long time to charge the Nintendo DSi Rechargeable Battery Pak

- **Are you playing a game or recharging the Battery Pak in a location with an ambient temperature less than 5 degrees Celsius?**

In environments with a temperature less than 5 degrees Celsius, you will not be able to play games for long periods of time, and the Battery Pak will take longer than usual to recharge.

## I can't use the Touch Screen / The Touch Screen does not respond properly

- **Has the alignment of the Touch Screen shifted?**

If positions are no longer aligned properly, use the TOUCH SCREEN option in System Settings to correct them. [Page 77](#) →



- **Have you attached a commercially-available protective sheet to the Touch Screen?**

If you have applied a commercially-available protective sheet to the Touch Screen, refer to its instruction manual and be sure it has been applied correctly before attempting to calibrate the Touch Screen.

## My SD Memory Card is not responding

- **Has the SD Card been correctly inserted into the system?**

Insert the SD Card gently but firmly until it clicks into place in the SD Card slot on the side of the system.

- **Is the SD Card broken?**

Use a computer or digital camera to confirm that you can correctly see files on the SD Card.

- **Are there photos on the SD Card that can be displayed using Nintendo DSi Camera?**

Nintendo DSi Camera can only display photos taken on the Nintendo DSi system. Photos taken on a digital camera or mobile phone will not be displayed.



- **Are there files on the SD Card that can be played back using Nintendo DSi Sound?**

Nintendo DSi Sound can play AAC files with a file extension of .m4a, .mp4 and .3gp. Non-AAC audio files (such as MP3 files) cannot be played back.

## Nintendo DSi Camera repeatedly asks for a photo of my face, but does not respond

This occurs when your face cannot be properly recognised. Move to a well-lit area and turn your face in a direction that allows it to be clearly displayed on-screen. Please also take note of the following factors which may also affect face recognition.

- The ambient brightness and lighting
- Haircut (when hair covers the face, for instance)
- Hair and eyebrow colour
- Sheen on the face and head
- The shape, colour and thickness of any facial hair
- Glasses, jewellery and piercings on the face and head



## My eyes and mouth are not being recognised correctly by Nintendo DSi Camera

Individual differences and the surrounding environment may prevent face recognition from working properly. If the position of your eyes and mouth are not recognised correctly, move to a well-lit area and turn your face in a direction that allows it to be captured well on-screen. Please also take note of the aforementioned factors.

## Images taken by the camera have strange colours

Make sure that you are using only the Normal lens (other lenses can cause strange colours to appear in your photos) and try to take a picture of something else. If the colours are still strange, contact the Nintendo Service Centre. [Page 117 →](#)

## I can't exchange photos or frames with Nintendo DSi Camera

- **Do Parental Controls restrict the wireless transmission of photo data?**  
Enter your PIN and either disable Parental Controls temporarily, or disable the Parental Controls item that restricts the wireless transmission of photo data.

[Page 107 →](#)

## Nintendo DSi Sound does not display audio files and folders

- **Has the SD Card been correctly inserted into the system?**  
Insert the SD Card gently but firmly until it clicks into place in the SD Card slot on the side of the system.
- **Does the SD Card contain saved audio files that can be played back using Nintendo DSi Sound?**  
Nintendo DSi Sound can play AAC files with a file extension of .m4a, .mp4 and .3gp. Non-AAC audio files (such as MP3 files) cannot be played back.
- **Are there more than 3000 audio files saved?**  
No more than 3000 audio files can be displayed.
- **Are there more than 1000 folders with saved audio files?**  
No more than 1000 folders can be displayed.
- **Are there more than 100 audio files saved in a single folder?**  
No more than 100 files can be displayed for a single folder. If there are folders with the same name on the SD Card, the audio files in those folders will be consolidated and displayed as a single folder. No more than 100 files can be displayed for this single consolidated folder.
- **Are audio files saved to a folder that is more than eight levels deep?**  
Nintendo DSi Sound will only check for files up to eight directories deep.

## I cannot play back audio files using Nintendo DSi Sound

- **Are the audio files in a format that can be played by Nintendo DSi Sound?**  
Nintendo DSi Sound can play audio files in the following format.
  - File format: AAC (.m4a, .mp4 or .3gp)
  - Bit rate: 16–320 kbps
  - Sampling frequency: 32–48 kHz

## I cannot download new games from the Nintendo DSi Shop

- **Do you have an insufficient Nintendo DSi Point balance?**  
Use one of the following to register Nintendo DSi Points with the Nintendo DSi system
  - Credit card (VISA or MasterCard)
  - Nintendo Points Card (this can be purchased from a Nintendo retailer)

Note: You can register Nintendo DSi Points using Wii Points Cards.  
For details on registration: [Page 59 →](#)

- **Have Parental Controls restricted the use of Nintendo DSi Points in the Nintendo DSi Shop?**  
Enter your PIN and either disable Parental Controls temporarily, or disable the Parental Controls item restricting the use of Nintendo DSi Points. [Page 107 →](#)

## I can't use DS Download Play

- **Have Parental Controls restricted the use of DS Download Play?**  
Enter your PIN and either disable Parental Controls temporarily, or disable the Parental Controls item restricting the use of DS Download Play. [Page 107 →](#)

## I can't use PictoChat

- **Are there already 16 people in the selected chat room?**  
No more than 16 people can enter a single chat room.
- **Have Parental Controls restricted the use of PictoChat?**  
Enter your PIN and either disable Parental Controls temporarily, or disable the Parental Controls item restricting the use of PictoChat. [Page 107 →](#)

I'm having difficulty using DS Wireless Communications (Communications are interrupted and the game cannot be played smoothly)

- **Is one of the following Reception Strength icons shown on-screen?**  
Reception strength appears to be poor. Move closer to the other player, and remove obstructions between you and that person.



### My system suddenly enters Sleep Mode

It may have entered **Sleep Mode** as the result of an external magnetic field. Move your system away from magnetic objects.



### I cannot disable Parental Controls

- **Did you enter the correct PIN?**  
Enter the correct PIN.  
If you have forgotten your PIN: [Page 108](#) →
- **Did you enter the correct answer to your secret question?**  
Enter the correct answer to your secret question.  
If you have also forgotten the answer to your secret question: [Page 108](#) →

If your Nintendo DSi system still does not operate correctly after trying the above remedies, please call the Nintendo Service Centre. [Page 117](#) →

## How to Disable Parental Controls

There are two ways to disable Parental Controls. You can either temporarily disable them, or change the Parental Controls settings.

### Temporarily Disabling Parental Controls

- 1 Enter your PIN at the screen that is displayed when you select the restricted item.
- 2 Touch OK.



### Changing the Parental Controls Setting

- 1 Go to the **System Settings Menu** and select

[Parental Controls](#).



- 2 Touch [Yes](#).



- 3 Enter your PIN.

- 4 Touch [OK](#).

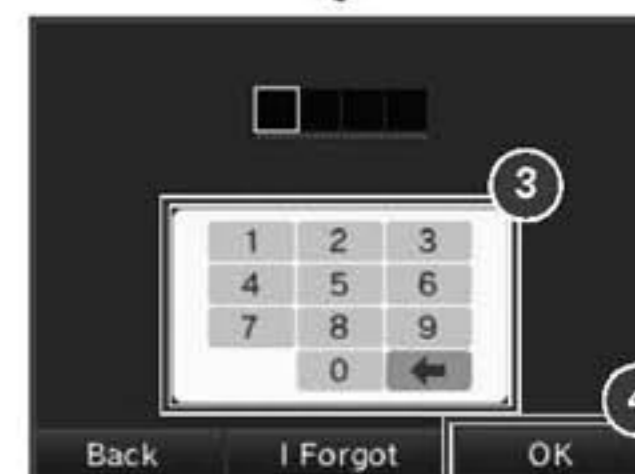

- 5 Touch [Change Settings](#).



Next, follow the on-screen instructions to change restricted content.

NOT FOR

### If you have forgotten your PIN or the answer to your secret question

In the event that you forget your PIN or the answer to your secret question, follow these steps.

- 1 At the PIN entry screen, touch **I Forgot**.



- 2 Enter the answer to your secret question.  
**Note:** You will go to the **Parental Controls Settings Screen** if you can answer this.



If you have also forgotten the answer to your secret question:

- 3 Once again, touch **I Forgot**.

- 4 An Enquiry Number will be displayed. Give the Nintendo Service Centre your reference number. You will be issued a master key.

**Page 117** →

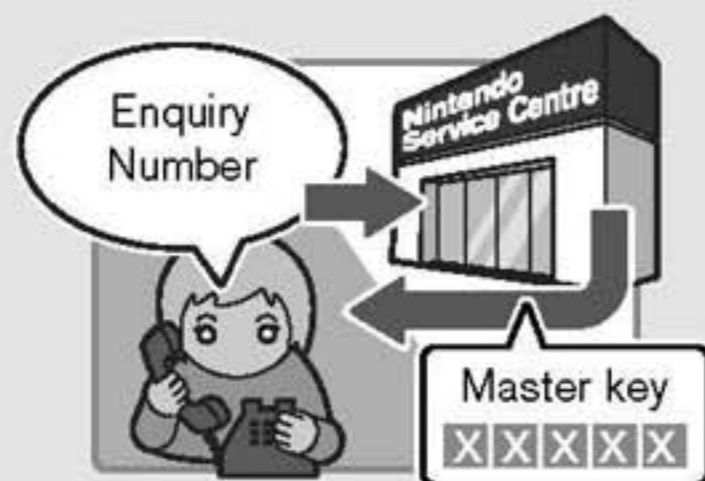

- 5 Touch **OK**.

- 6 Enter the master key, and touch **OK**.



If an error occurs, the following messages may appear on-screen. Follow the directions shown in the table to solve the problem.

Error Message	Solution
An error has occurred. Press and hold the POWER Button to turn the system off. Please refer to the Nintendo DSi Operations Manual for details.	Turn the power off for a moment, then turn it back on. If you experience the same problem and the message appears again, turn the power off, and contact the Nintendo Service Centre. <b>Page 117</b> →
The System Memory is damaged. Please refer to the Nintendo DSi Operations Manual for details.	The System Memory is damaged. Please contact the Nintendo Service Centre. <b>Page 117</b> →
The device inserted in the SD Card slot can't be used.	An SD Card that cannot be used with the Nintendo DSi or something other than an SD Card is inserted in the SD Card slot, or the system region of the SD Card is corrupted. Please insert a functional SD Card that is compatible with the Nintendo DSi system.
There is not enough space on this SD Card.	Either erase unnecessary software on the SD Card from the <b>Data Management Screen</b> under System Settings <b>Page 68</b> → or erase unnecessary photos or frames from Nintendo DSi Camera. <b>Page 31</b> → Otherwise, use an SD Card that contains some available space.
There are no empty slots on the system.	There are no slots available in the <b>Nintendo DSi Menu</b> . Erase unnecessary software from the <b>Data Management Screen</b> under System Settings. <b>Page 68</b> →

If an error message other than those shown above is displayed, please contact the Nintendo Service Centre. **Page 117** →

NOT FOR

## Error Code List

Error codes will be displayed along with an error message if the internet settings weren't configured correctly or if the connection test failed. Check the solutions shown in the table below, the system's internet setting [Page 78 →](#), the Nintendo website, and the instruction manual for the network devices you're using.

**Note:** If you are using the Nintendo Wi-Fi USB Connector and cannot connect due to error codes 052003, 052103 or 052203, the error might be caused by the security software or firewall on your computer. For details, see the Nintendo website.

Error Codes	Problem	Solution
020100–020999	Could not connect to Nintendo Wi-Fi Connection.	
034301–034304	Cannot connect to the system update server.	
034300 034305–034499	The system could not be updated due to an internet error.	Wait for a while and try connecting again. If the issue persists, contact the Nintendo Service Centre. <a href="#">Page 117 →</a>
050100–050199	Unable to connect to the internet.	
023000–025999	The Nintendo Wi-Fi Connection servers are either undergoing maintenance or are very busy.	Wait for a while and try connecting again. If the issues persists, check the Nintendo website to see if the server is undergoing maintenance.
034000–034218 034500–034699	An error occurred, so the system could not be updated.	Please contact the Nintendo Service Centre. <a href="#">Page 117 →</a>
034219 034220	Insufficient free blocks in the System Memory.	Erase unnecessary software from the <b>Data Management Screen</b> under System Settings. <a href="#">Page 68 →</a>
050000–050099	No access point in range.	<ul style="list-style-type: none"> <li>Check the access point settings. The wireless signals may be too weak at your location.</li> <li>Try moving closer to your access point, and make sure there are no people, objects or other obstacles between the system and the access point.</li> <li>Make sure the access point is in a usable state. For details, see the instruction manual for your access point.</li> </ul>
050500–050599	You must accept the terms of use.	Agree to the terms of use. <a href="#">Page 78 →</a>
050600–050699	Wireless Communications is currently disabled under System Settings.	Enable the Wireless Communications setting. <a href="#">Page 69 →</a>
051000–051099	Could not find an access point with the SSID that has been set.	Check whether the SSID in the connection settings matches the settings for the access point you want to connect to.

Error Codes	Problem	Solution
051100–051199	Could not connect to the access point.	<ul style="list-style-type: none"> <li>Make sure the security key in the connection settings matches that of the access point.</li> <li>If you are using a Nintendo Wi-Fi USB Connector, configure your computer to allow connections. If this error code occurs even after connections are allowed, the wireless signals may be too weak at your location.</li> <li>Try moving closer to your access point, and make sure there are no people, objects or other obstacles between the system and the access point.</li> </ul>
051200–051299	Could not connect because the maximum number of simultaneous connections to the access point has been exceeded.	The access point you tried to connect has a limit on the number of devices that can connect to it. Wait for a while and try again.
051300–051399	Cannot connect to the access point for an unknown reason.	<ul style="list-style-type: none"> <li>See the solutions for error codes 051100–051299.</li> <li>Reconfigure the access point settings.</li> </ul>
052000–052099	Could not automatically acquire the IP address.	<ul style="list-style-type: none"> <li>Enable the DHCP server feature of your access point or other network device. If you cannot use the DHCP server feature, you will have to configure the IP address and other such settings manually. <a href="#">Page 78 →</a></li> <li>Make sure the security type and key of the connection settings match the settings for the access point you want to connect to.</li> </ul>
052100–052399 312004 312005	Could not connect to the internet.	<ul style="list-style-type: none"> <li>Confirm that your network environment can connect to the internet.</li> <li>Review the settings under AUTO-OBTAIN IP ADDRESS in the connection settings.</li> <li>If the AUTO-OBTAIN IP ADDRESS setting is set to NO, check whether the security type and key in the connection settings match the settings for the access point you want to connect to.</li> </ul>
052400–052599 312012 312013	Could not connect to the proxy server.	<ul style="list-style-type: none"> <li>Confirm that your network environment can connect to the proxy server.</li> <li>Review the proxy server settings.</li> </ul>
052700–052799	Cannot connect because there is another network device that is set to the same IP address.	Review the AUTO-OBTAIN IP ADDRESS setting in the connection settings.

Error Codes	Problem	Solution
053000–053299	Could not connect to the internet.	<ul style="list-style-type: none"> <li>The wireless signals may be too weak at your location. Try moving closer to your access point, and make sure there are no people, objects or other obstacles between the system and the access point.</li> </ul>
054000–054299 290500–290599 291000–291099	Communication error. You have been disconnected from the network.	<ul style="list-style-type: none"> <li>The wireless signals may be too weak at your location. Try moving closer to your access point, and make sure there are no people, objects or other obstacles between the system and the access point.</li> <li>This might be a temporary issue, so wait a while and then try again. If the issue persists, contact the Nintendo Service Centre.</li> </ul> <p><b>Page 117 →</b></p>

If an error message other than those shown above is displayed, please contact the Nintendo Service Centre. **Page 117 →**

At the end of this product's life, please do not dispose of this product in your general household waste. Instead, please dispose of this product separately in accordance with your local recycling laws and regulations. For more information on the separate collection systems for waste electrical and electronic equipment that are available for consumers, free of charge, near your home, please contact your local municipal authority.

As an alternative and if you plan to buy an equivalent new product, you may be able to bring this product to your local retailer who, in exchange for your buying an equivalent new product, may take back this product and arrange for its recycling. However, we would suggest that you first double-check with your local retailer whether they will offer you this service.

Either way, this product will then be treated in an environmentally sound manner at a licensed recycling plant and its components will be recovered, recycled or reused in the most efficient way possible, in compliance with the requirements of the Directive on Waste Electrical and Electronic Equipment (2002/96/EC) of 27 January 2003.

**Under applicable environmental laws, you should always use the available separate collection systems for waste electrical and electronic equipment. In some countries, failure to use these systems may even result in sanctions being taken against you.**

#### Notes:

1. Waste electrical and electronic equipment may contain hazardous substances, which, if not treated properly, can be harmful to the environment and human health. Specific treatment of waste electrical and electronic equipment is therefore indispensable.
2. All Nintendo electrical and electronic equipment that is subject to the above Directive is designed in a way which takes full account of, and facilitates, its possible repair, upgrading, reuse, dismantling and recycling.
3. Nintendo and its official distributors support recycling schemes in each European country and are committed to using the best available treatment, recovery and recycling techniques in order to ensure both human health and high environmental protection.
4. The crossed-out wheeled bin symbol (see below) is affixed to all relevant Nintendo electrical and electronic equipment that has been put onto the market by Nintendo or its official distributors on or after 13 August 2005. The symbol means that these products must be collected separately from other waste at the end of their life, in order to ensure maximum recovery and environmentally sound disposal.







## Specifications

### Nintendo DSi system

Model Number	TWL-001(EUR)
LCD Screens	Transmissive TFT Colour LCD (can display 260,000 colours)
Screen Size	3.25 inches (66.0 mm wide x 49.5 mm high)
Number of Pixels	256 x 192 pixels
Power Sources Used	Nintendo DSi Power Supply (WAP-002(EUR)) Nintendo DSi Rechargeable Battery Pak (TWL-003)
Wireless Frequency	2.4 GHz Band
Output Power	11b: 5.5 dBm / 11g: 5.0 dBm maximum
Communication Standard	Communication Standard IEEE 802.11 b/g (DSSS/OFDM)
Recommended Communication Distance	Approx. 10–30 m <b>Note:</b> The maximum distance at which communication is possible may be reduced depending on the surroundings. Only use these figures as a rough estimate.
Camera Feature	Lens: Fixed focal length / Image sensor: CMOS / Effective pixels: about 300,000
Clock Feature	Max. Daily Variation of $\pm 4$ seconds (when used within the "Usable Environment" below)
Input / Output Terminals	Game Card slot, SD Card slot, Power Supply connector, audio jack
Maximum Power Consumption	Approx. 2.8 W (when charging)
Usable Environment	Temperature: 5–35 degrees Celsius / Humidity: 20–80 %
Dimensions	74.9 mm high x 137.0 mm wide x 18.9 mm thick (when closed)
Mass	Approx. 214 g (including Battery Pak and stylus)
Charge Time	Approx. 2 hours and 30 minutes
Battery Life	The battery life will change depending on the brightness of the LCD screens.

#### Battery Life

Battery life will also vary depending on factors such as the software being used and the ambient temperature. As such, these times should only be taken as rough estimates. Using the wireless communication or camera features may reduce the battery time below the figures shown to the right.

**Note:** The system is configured to the "High" brightness setting when shipped from the factory.

	Highest	Approx. 3–4 hours
	High	Approx. 4–6 hours
	Medium	Approx. 6–9 hours
	Low	Approx. 8–12 hours
	Lowest	Approx. 9–14 hours

### Nintendo DSi Power Supply

Model Number	WAP-002(EUR)
Input / Output	AC 230V 50Hz / DC 4.6V 900mA
Dimensions / Weight	70.5 mm long x 27.0 mm wide x 84.5 mm thick / Approx. 80 g
Cord Length	Approx. 1.9 m

### Nintendo DSi stylus

Model Number	TWL-004
Material	Plastic parts (stylus body (ABS) / stylus tip (PE))
Dimensions / Weight	Approx. 92.0 mm / Approx. 1.7 g

**Note:** In the course of making improvements, changes to any of these specifications may be made without notice.

## Notes



## 12 MONTHS WARRANTY - NINTENDO DSi HARDWARE

### CONSUMER WARRANTY

This warranty covers the Nintendo DSi system and the original built-in software included with the Nintendo DSi system at the time of purchase (the "Nintendo DSi Operating Software"). (In this warranty, the Nintendo DSi system and the Nintendo DSi Operating Software are together referred to as the "Product").

Subject to the terms and exclusions below, Nintendo warrants to the original consumer purchasing the Product ("you") that, for a period of 12 months from the date of the purchase of the Product by you, the Product will be free from defects in materials and workmanship.

To make a valid claim under this warranty, you must notify Nintendo of the defect in the Product within 12 months of the date of the purchase of the Product by you and you must return the Product to Nintendo within 30 days of notifying Nintendo of that defect. If, having inspected the Product, Nintendo accepts that the Product is defective, Nintendo will (at its sole discretion) either repair or replace the part causing the defect or replace the Product without charge.

This warranty does not affect your statutory rights.

### EXCLUSIONS

This warranty does not cover:

- software (other than the Nintendo DSi Operating Software) or games (whether or not included with the Product at the time of purchase);
- accessories, peripherals or other items that are intended for use with the Product but are not manufactured by or for Nintendo (whether or not included with the Product at the time of purchase);
- the Product if it was intended for sale outside the European Economic Area;
- the Product if it has been resold, or used for rental or commercial purposes;
- defects in the Product that are caused by accidental damage, your and/or any third party's negligence, unreasonable use, use with products not supplied or licensed by Nintendo (including, but not limited to, non-licensed game enhancements, copier devices, adapters, power supplies or non-licensed accessories), computer viruses or connecting to the internet, use of the Product otherwise than in accordance with the Nintendo DSi Operations Manual or any other instructions provided with the Product, or any other cause unrelated to defects in material and workmanship;
- gradual decrease over time in the capacity and performance of the Nintendo DSi Rechargeable Battery Pak (TWL-003) (which, to avoid any doubt, will not be deemed to be a defect in material or workmanship of the Product).
- the Product if it has been opened, modified or repaired by any person other than Nintendo or it has its serial number altered, defaced or removed; or
- loss of any data loaded or stored on the Product by any person other than Nintendo.

### HOW TO MAKE A CLAIM

To notify Nintendo of a defect covered by this warranty, please contact:

**Nintendo Service Centre**  
Codestorm House, Walton Road, Farlington, Hampshire PO6 1TR, Tel: +44 (0) 870 60 60 247

(calls are charged at National Rates for UK customers and International Rates for Irish customers - please obtain permission from the person responsible for the bill before calling).

Before sending the Product to the Nintendo Service Centre, you should remove or delete any private or confidential files or data. You accept and agree that Nintendo will not be responsible for any loss, deletion or corruption of your files or data that have not been deleted or removed. Nintendo strongly recommends that you make a back up copy of any data that you do not remove or delete.

When sending the Product to the Nintendo Service Centre, please:

1. use the original packaging where possible;
2. provide a description of the defect;
3. attach a copy of your proof of purchase, ensuring that it contains the date of purchase of the Product; and
4. ensure that it is received by Nintendo within 30 days of the original notification of a qualifying defect.

If the above 12 months warranty period has expired at the time the defect is discovered or if the defect is not covered by this warranty, Nintendo may still be prepared to repair or replace the part causing the defect or replace the Product (at its sole discretion). For further information about this and, in particular, the details of any charges for such services, please contact:

**Nintendo Service Centre**  
Tel: +44 (0) 870 60 60 247

(calls are charged at National Rates for UK customers and International Rates for Irish customers - please obtain permission from the person responsible for the bill before calling).

### NINTENDO DSi OPERATING SOFTWARE

The Nintendo DSi Operating Software may only be used with the Product and may not be used for any other purpose. You must not copy, adapt, reverse engineer, decompile, disassemble or modify the Nintendo DSi Operating Software other than as expressly permitted by applicable law. Nintendo may use anti-copying or other measures to protect its rights in the Nintendo DSi Operating Software.



# HOTLINE

Call our games hotline for assistance on all Nintendo published/distributed software, hardware and accessories. Our dedicated games counsellors can answer all your gameplay questions offering hints, tips and strategies to ensure that you get the most from your Nintendo products.

To call the hotline, dial\*

## +44 (0) 870 60 60 247

(\* Calls from a landline within the UK are charged at the standard national rate offered by the caller's network provider. Charges may vary for calls made using a mobile phone.

Customers calling from outside the UK will be charged at the international rate offered by the provider of the network being used to make the international call.

Please obtain permission from the person responsible for paying the bill before calling.)

Lines are open Monday to Friday from 08:30 to 19:00, and Saturday from 08:30 to 15:30\*\*.

(\*\* Charges and opening hours are correct at time of printing – November 2008 – but are subject to change without prior notice.)